

Fuse Panel Installation Instructions

Following these simple instructions will guarantee a successful installation of your Power Plus 12 System. The order of installation will be as follows:

1. Mount fuse panel
2. Route fuse panel harness in dash area
3. Make all dash connections as shown in this Fuse Panel Installation sheet.
4. Starting with bag "J", install all other wiring bags as per the letter designation on instruction sheets. (bags J,K,L,M).

Let's begin your installation with this Fuse Panel harness. Study the diagram below, and follow the installation procedures on the following pages!

RECOMMENDED FUSE CIRCUIT RATINGS			
PARK LIGHTS	10 AMP	CRUISE	15 AMP
HAZARD	15 AMP	CLOCK	5 AMP
BRAKE LIGHTS	10 AMP	LIGHTER	10 AMP
HEADLIGHTS	30 AMP	FUEL PUMP	15 AMP
TURN SIGNAL	10 AMP	POWER SEAT	30 AMP
WIPER	10 AMP	POWER LOCK	30 AMP
GAUGE	5 AMP	POWER WINDOWS	30 AMP
C.B. RADIO	5 AMP		
A/C / HEATER	30 AMP		
RADIO	5 AMP		
FAN	30 AMP		

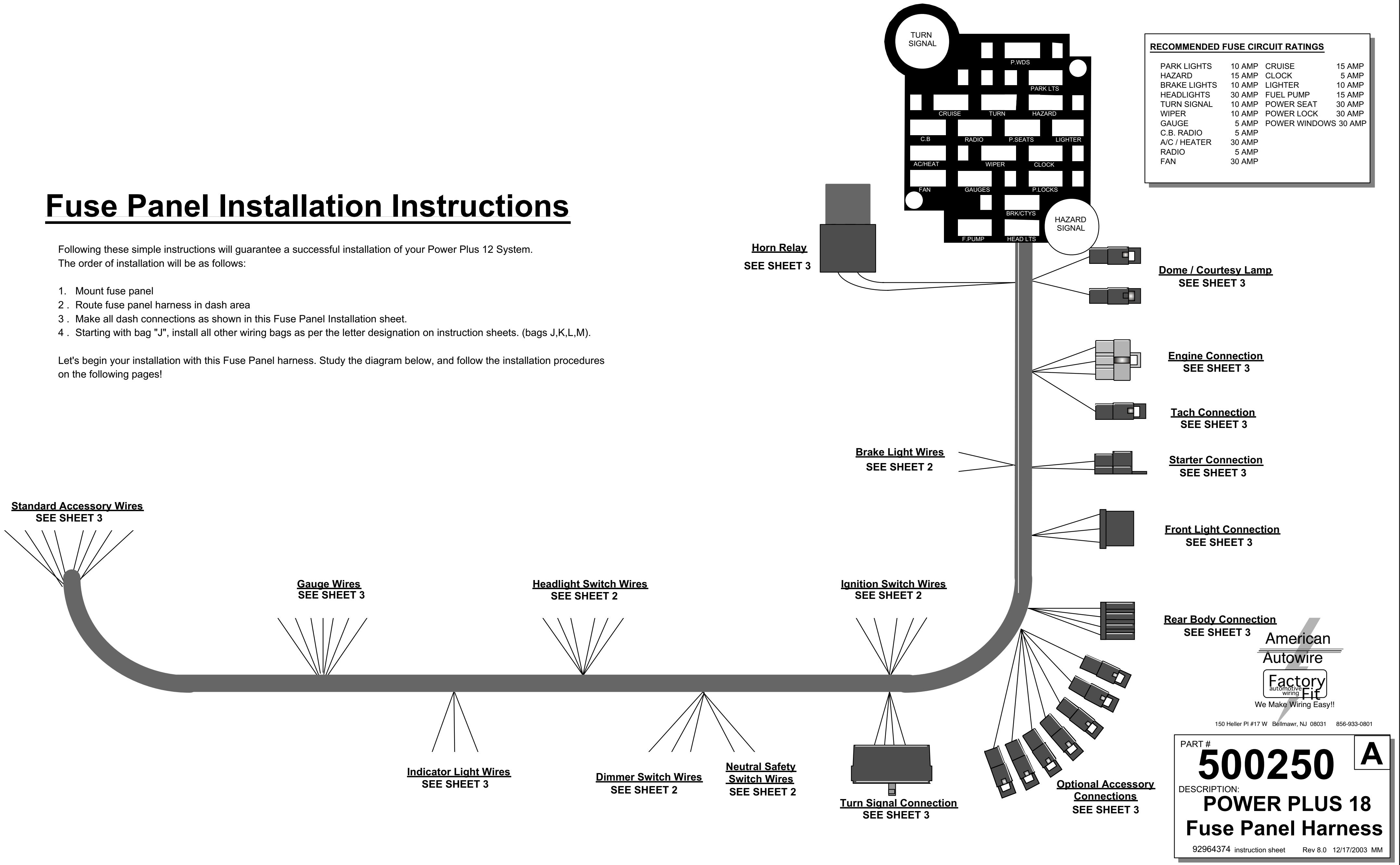

PART # **500250** **A**

DESCRIPTION: **POWER PLUS 18 Fuse Panel Harness**

92964374 instruction sheet Rev 8.0 12/17/2003 MM

Loose Wire Connections

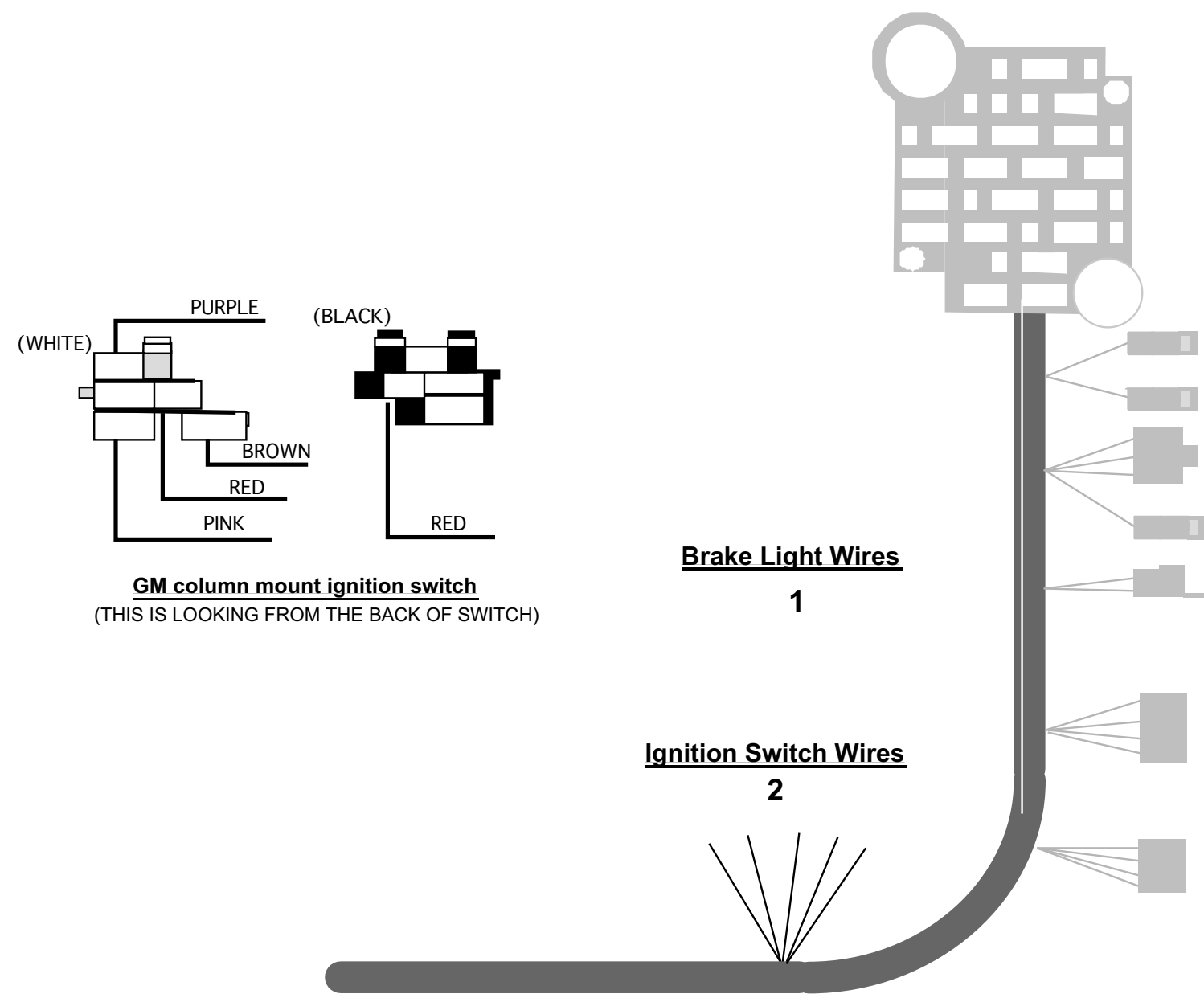

Note: Terminals are provided for most connections on your wiring kit. Use the provided terminals and connector to install the following wires:

Terminal	Color	Description	Connection
1	Orange	12 volt feed to brake switch	Connect this wire to one side of your brake switch.
	White	12 volt feed out from brake switch	Both white wires go to the other available location on the brake switch.
2	Red	12 volt feed to ignition switch	Connect to the "BAT" location on ignition switch. (white connector)
	Red	12 volt feed to ignition switch	Connect to the "BAT" location on ignition switch. (black connector)
	Pink	12 volt ignition feed	Connect this to the "IGN" location on ignition switch.
	Brown	12 volt accessory feed	Connect this to the "ACC" location on ignition switch.
	Purple	12 volt feed to starter (via Nuet saf sw)	Connect this wire to the "ST" location on ignition switch.

Loose Wire Connections

Typical GM headlight switch shown

(THIS IS LOOKING FROM THE BACK OF SWITCH)

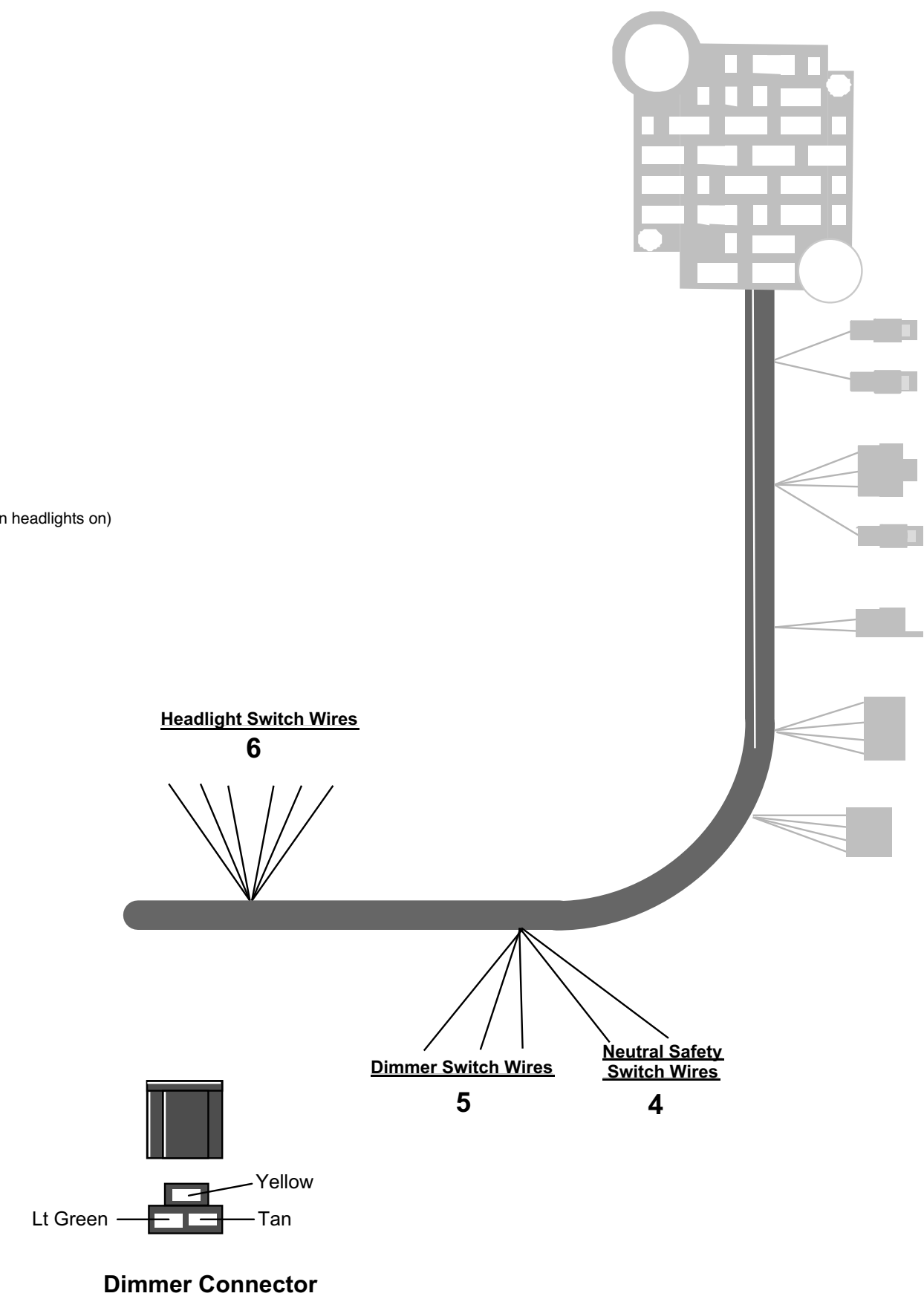
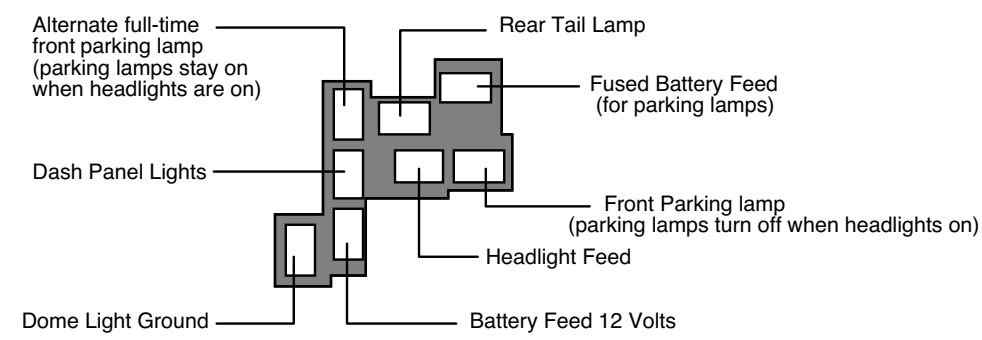

Note: Terminals are provided for most connections on your wiring kit. Use the provided terminals and connector to install the following wires:

Terminal	Color	Description	Connection
4	Purple	12 volt feed to starter	Each purple wire will go to one side of the neutral safety switch, if applicable. Note: These wires MUST be connected for the vehicle to start!
5	Yellow	12 volt feed to dimmer switch	Connect to the dimmer "FEED IN" location on dimmer switch.
	Tan	Lo beam feed from dimmer switch	Connect this to the "LO BEAM" feed out location on dimmer switch.
	Lt Green	Hi beam feed from dimmer switch	Connect this to the "HI BEAM" feed out location on dimmer switch.
6	Red	12 volt feed to switch	Connect to the "BAT" location on headlight switch.
	Orange	12 volt feed "in" to park/tail	Connect to the "PARK / TAIL FEED IN" location on headlight switch. (commonly found on GM headlight switches)
	Brown	Park / tail feed "out"	Connect to the "PARK / TAIL FEED OUT" location on headlight switch.
	Yellow	Dimmer feed	Connect to the "DIMMER FEED" location on headlight switch.
	Gray	Instrument lamp feed	Connect to the "INSTRUMENT LAMP" location on headlight switch.
	White	Dome / courtesy ground	Connect to the switched "GROUND" location on headlight switch.

POWER PLUS 18
Fuse Panel Harness

500250

Loose Wire Connections

- 10 HORN RELAY
- 11 DOME / COURTESY LAMP
- 12 ENGINE CONNECTION
- 13 TACH CONNECTION
- 14 STARTER CONNECTION
- 15 FRONT LIGHT CONNECTION
- 16 REAR BODY CONNECTION
- 17 OPTIONAL ACCESSORIES

No further connection necessary. Ready to use as supplied.
 Orange wire- Connect this wire to your dome / courtesy bulb (feed location).
 White wire- Connect this wire to the ground side of the dome / courtesy bulb.
 This wire is activated by the headlight switch ground.
 Your engine wiring connector from bag "K" will plug in here later in the installation process.
 Your tachometer connector from bag "K" will plug in here later in the installation process.
 Your starter connector from bag "M" will plug in here later in the installation process.
 Your front light connector from bag "L" will plug in here later in the installation process.
 Your rear body connector from bag "J" will plug in here later in the installation process.
 These leads can be used for any accessory. Recommended uses are as follows:

- Pink (small gauge) Fused 12 volt power for cruise control.
- Yellow Fused 12 volt power for clock.
- Orange (small gauge) Fused 12 volt power for lighter.
- Dk Blue Fused 12 volt power for fuel pump.
- Orange (large gauge) Fused 12 volt power for power seats.
- Red Fused 12 volt power for power locks.
- Pink (large gauge) Fused 12 volt power for power windows.

Accessory Wires

9

Gauge Wires

8

Indicator Light Wires

7

Note: Terminals are provided for most connections on your wiring kit. Following the gauge manufacturer's instructions, use the terminals supplied with your gauge kit to connect gauge wires to the gauges. NOTE: Gauge disconnects are provided for ease of gauge installation!

- | | | | | |
|---|------------------|--|---|--|
| 7 | INDICATOR LIGHTS | Lt Blue
Dk Blue
Lt Green | LH dash indicator
RH dash indicator
Hi-beam indicator | Connect this wire to the LH dash indicator light.
Connect this wire to the RH dash indicator light.
Connect this wire to the hi-beam indicator lamp. |
| 8 | GAUGE WIRES | Dk Green
Dk Blue
Tan
White
Black
Pink
Grey | Temperature sender wire
Oil sender wire
Gas sender wire
Tach sender wire
Ground | Connect to the "SENDER" location on gauge.
Connect to the "SENDER" location on gauge.
Connect to the "SENDER" location on gauge.
Connect to the "SENDER" location on gauge. (-)
Connect to each gauge (ground location) as shown in diagram. |
| 9 | ACCESSORY WIRES | Black
Brown
Orange
Orange
Orange
Tan
White | 12 volt ignition feed
Instrument lamp feed
Instrument cluster ground
A/C-heat 12 volt feed-fused (heavy gauge) Blower lead
(short length) Electric fan feed-fused
(longer length) Electric fan lead
Radio feed - fused
Wiper | Connect to each gauge (12 v location) as shown in diagram.
Connect to instrument lamp, as shown in diagram.
Connect to a GOOD chassis ground.
Connect to the A/C heat-switch (feed "in" location)
Connect to the A/C-heat switch (power "out" location)
Connect to the Electric fan switch (feed "in" location)
Connect to the Electric fan switch (feed "out" location)
Connect to the radio power location.
Connect to the wiper system following manufacturer's instructions. |

POWER PLUS 18
Fuse Panel Harness

500250

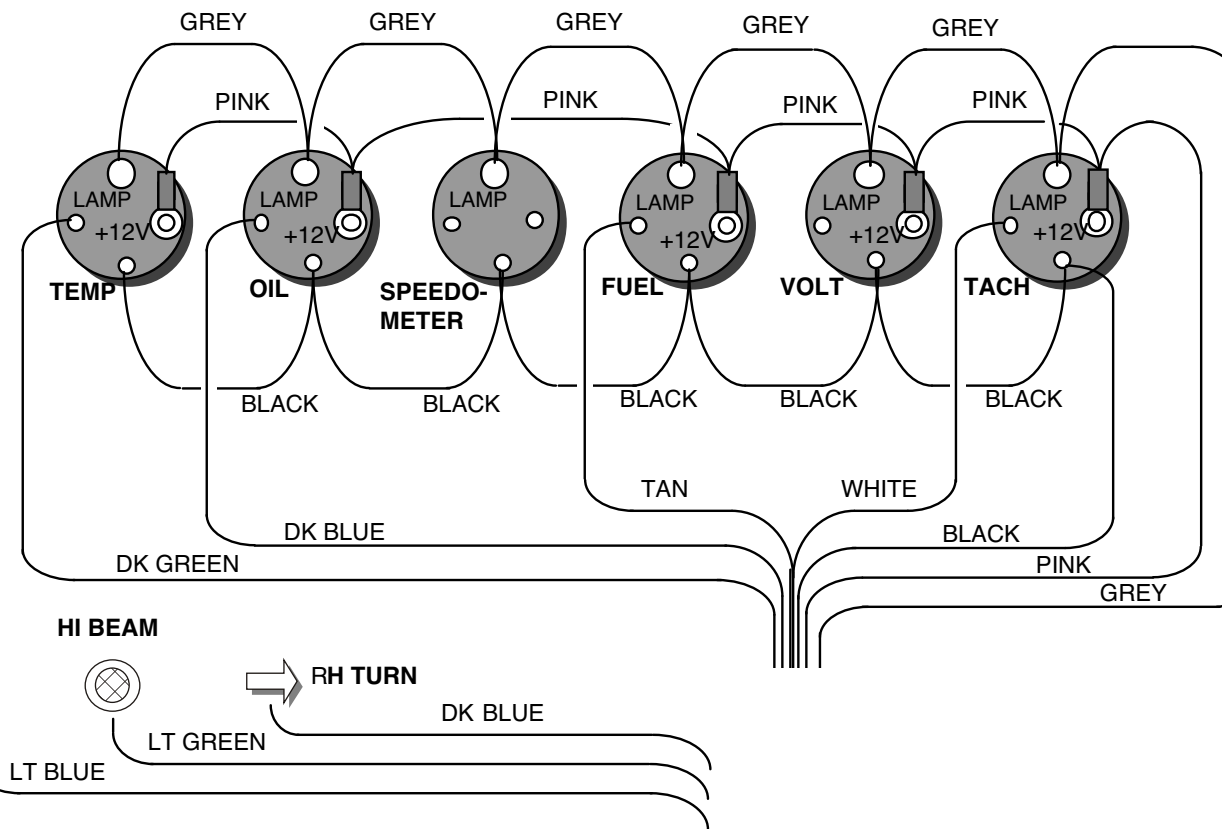

Gauge Connections

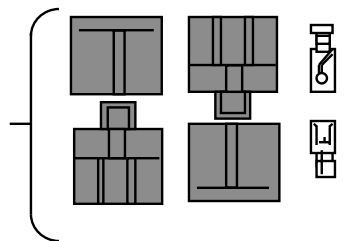

Connector Plug-In's

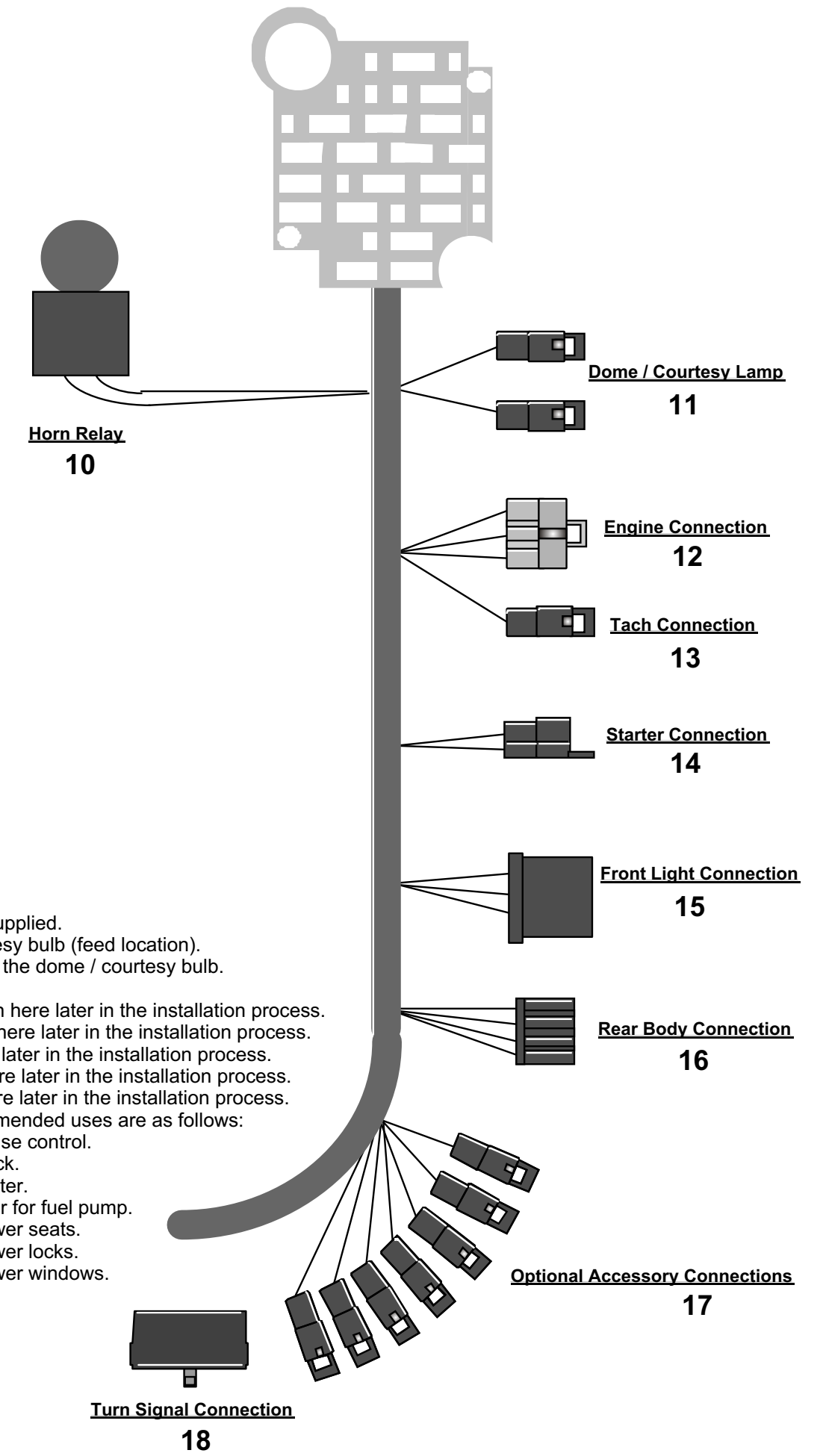

- 10 HORN RELAY
 - 11 DOME / COURTESY LAMP
 - 12 ENGINE CONNECTION
 - 13 TACH CONNECTION
 - 14 STARTER CONNECTION
 - 15 FRONT LIGHT CONNECTION
 - 16 REAR BODY CONNECTION
 - 17 OPTIONAL ACCESSORIES
 - 18 TURN SIGNAL
- No further connection necessary. Ready to use as supplied.
 Orange wire- Connect this wire to your dome / courtesy bulb (feed location).
 White wire- Connect this wire to the ground side of the dome / courtesy bulb.
 This wire is activated by the headlight switch ground.
 Your engine wiring connector from bag "K" will plug in here later in the installation process.
 Your tachometer connector from bag "K" will plug in here later in the installation process.
 Your starter connector from bag "M" will plug in here later in the installation process.
 Your rear body connector from bag "J" will plug in here later in the installation process.
 These leads can be used for any accessory. Recommended uses are as follows:
- Pink (small gauge) Fused 12 volt power for cruise control.
 - Yellow Fused 12 volt power for clock.
 - Orange (small gauge) Fused 12 volt power for lighter.
 - Dk Blue Fused 12 volt power for fuel pump.
 - Orange (large gauge) Fused 12 volt power for power seats.
 - Red Fused 12 volt power for power locks.
 - Pink (large gauge) Fused 12 volt power for power windows.
- Purple Turn flasher feed
 Brown Hazard flasher feed
 Lt Blue Left front turn lead
 Dk Blue Right front turn lead
 Yellow Left rear turn / brake lead
 Dk Green Right rear turn / brake lead
 White Brake light feed into switch
 Black Horn button lead

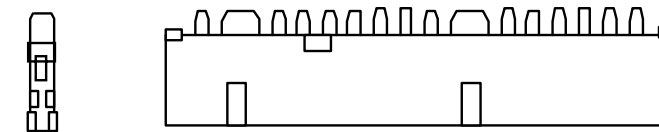

This kit includes connection to the more common GM 3 7/8" column connector. Install as follows:

1. If your column has the GM 3 7/8" connector, just plug them together.
2. If your column has the GM 4 1/4" connector, remove the terminals from the GM 4 1/4" connector and plug them into the supplied GM 3 7/8" mating connector matching the wires from your column to our harness by "color".
3. If you are using any other connector on your column, remove your existing connector and install the supplied terminals and the new 3 7/8" connector. You must match the wires from your column to our harness by "function".