

Classic Update Series

1957 CHEVY

START HERE !

PLEASE READ THIS BEFORE STARTING INSTALLATION !

This wiring kit is designed for ease of installation. Please read the guidelines below, BEFORE STARTING your installation to guarantee a successful job. Use an appropriate crimping tool which folds the wings of the open barrel terminals down into the wire as shown below. ALL TERMINALS THAT YOU INSTALL SHOULD BE PROPERLY SOLDERED. Our factory crimped terminations are installed by GM approved five ton presses, and soldering these terminations is not necessary. AAW offers a great terminal crimping video entitled "Proper Crimping Video". It can be viewed by visiting YouTube. Type the following address into your web browser to go directly to the video: www.youtube.com/watch?v=8u_EkMsi0My.



AS THIS HARNESS IS DESIGNED FOR USE IN A MODIFIED CAR REQUIRING A HIGHER RATE OF CHARGE, IT DOES NOT SUPPORT THE USE OF A STOCK (ORIGINAL) GENERATOR. IT IS DESIGNED FOR USE WITH AN INTERNALLY REGULATED "SI" OR SINGLE WIRE STYLE ALTERNATOR. IT CAN ALSO BE USED WITH THE LATER "CS" AND "CS-D" UNITS BY USING ALTERNATOR ADAPTERS WHICH ARE SOLD SEPARATELY. CONTACT AAW OR YOUR FAVORITE DEALER FOR THE PROPER ALTERNATOR ADAPTER FOR YOUR CAR.

STEP 1: DISCONNECT YOUR BATTERY:

Disconnect the battery before installing the wiring kit to prevent any accidental shorting caused by loose bare wire ends.

STEP 2: START INSTALLING KIT:

This kit is broken down into individual steps that are identified by a letter printed on the instruction sheets visible through each bag. These letters are the order of operation for installing your kit. Start with the bag letter "G", then "H", etc. The order of installation is shown below.

G	500433	Dash Harness Kit
H	510409	Gauge Cluster Kit
J	510405	Engine Kit
K	510410	Park / Headlamp Connection Kit
L	500432	Front Light Kit
M	510404	Rear Body Kit
N	500471	Courtesy Light Connection Kit
Z	510476	Alternator and Main Connection Kit

STEP 3: RECONNECT YOUR BATTERY:

When you have completed the installation and are ready to reconnect the battery, make sure that the following electrical system grounds are in place:

- Battery is grounded to the ENGINE BLOCK.
- Battery is grounded to the frame.
- Engine block is grounded to the frame.
- Body is grounded to the frame.

STEP 4: CHECK ALL ELECTRICAL FUNCTIONS:

Any non-functioning items should be checked for proper installation. Any problems with your wiring and electrical circuit functions should be addressed to American Autowire Systems, Inc. as soon as possible to avoid any warranty problems.

If you have any questions concerning this or any of our products, please feel free to call us at 1-800-482-WIRE.

"AMERICAN AUTOWIRE MAKES IT EASY !!!"

100% MADE IN U.S.A.!!

also available from
American Autowire

Hood & trunk lights
Door jamb switches
Custom battery cables
Master disconnect switch
Adjustable Fuel Warning Module
Terminals, connectors, grommets, light sockets
Billet turn signal knobs
Neutral safety switch
Glove box light
LED lights
...AND MUCH MORE !

OPTIONAL ACCESSORY KITS

Brake Switch	p/n 500097	Button type, 2 blade contact to operate brake lights.
Brake Switch	p/n 500145	Button type, 4 blade contact to operate brake lights & cruise control / lock up converter.
Universal Relay Kit	p/n 500479	Complete relay kit with wiring and relay.
Wiper Switch	p/n 500146	Two speed wiper switch.
Ign. Sw. Tumbler	p/n 500672	New tumbler and key for your new Classic Update or stock original 1957 ignition switch.
Convertible Top Kit	p/n 500444	Power top wiring from power source to switch to motor assembly, complete.
Turn Signal Switch	p/n 37789	1957 Stock turn signal switch.
Assembly Manual	p/n 36316	1957 Factory assembly manual.
Back-Up Lamp Kit	p/n 500437	1957 Back up lamp kit assembly (includes sockets, mounting plates, contacts, & seal boots).
Grille Bar Grommet and Connector kit	p/n 500548	1957 Front splash pan grommet and connector kit for grille bar and horns.



**American
Autowire**

www.americanautowire.com 856-933-0801

PART #
500434

DESCRIPTION:

**FULL VEHICLE WIRING KIT
1957 CHEVROLET**

92965107 instruction sheet Rev 6.0 1/10/2018

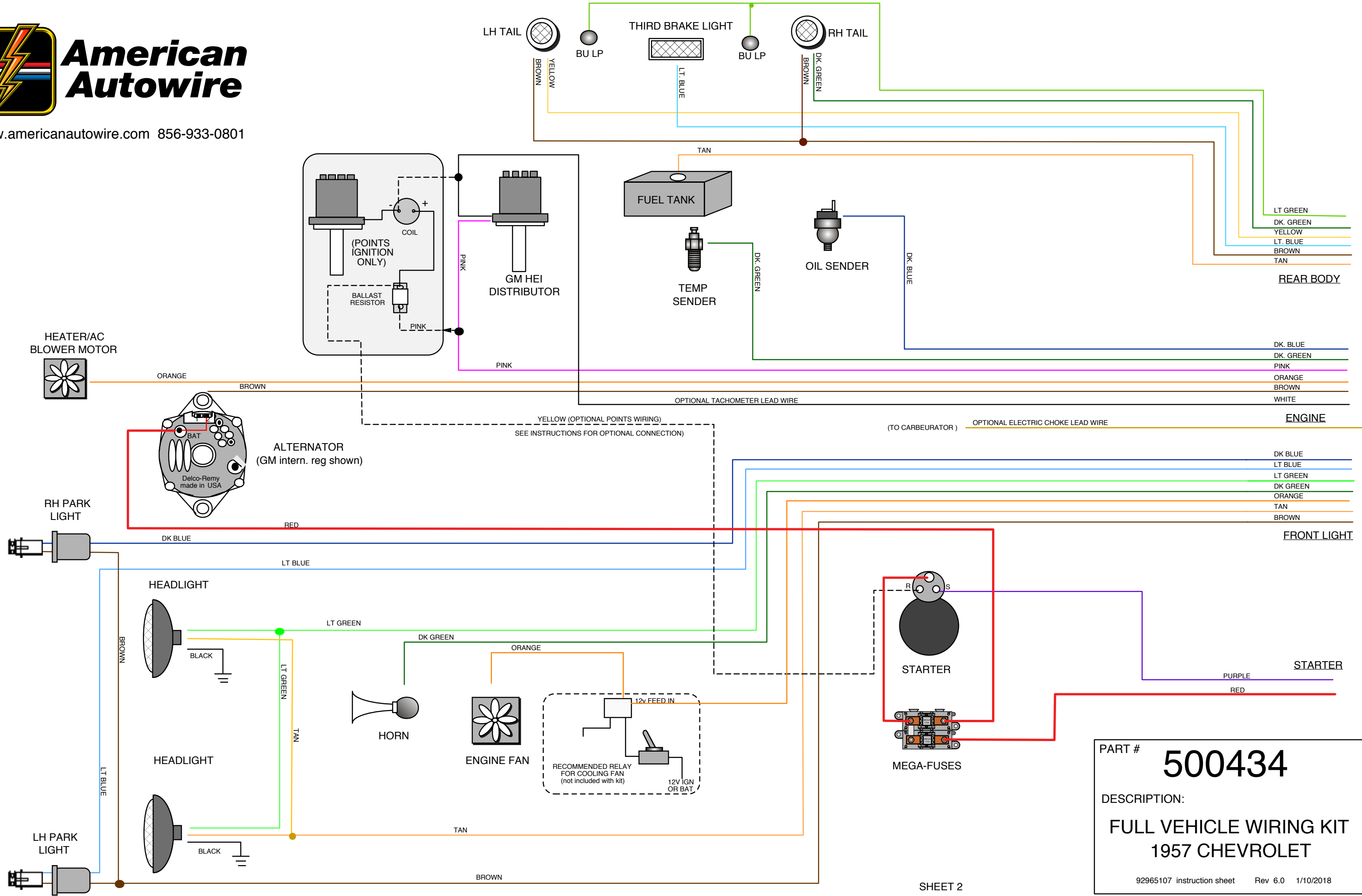

PART # **500434**

DESCRIPTION:
FULL VEHICLE WIRING KIT
1957 CHEVROLET

92965107 instruction sheet Rev 6.0 1/10/2018

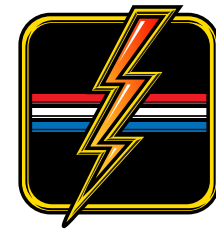

American Autowire

www.americanautowire.com 856-933-0801

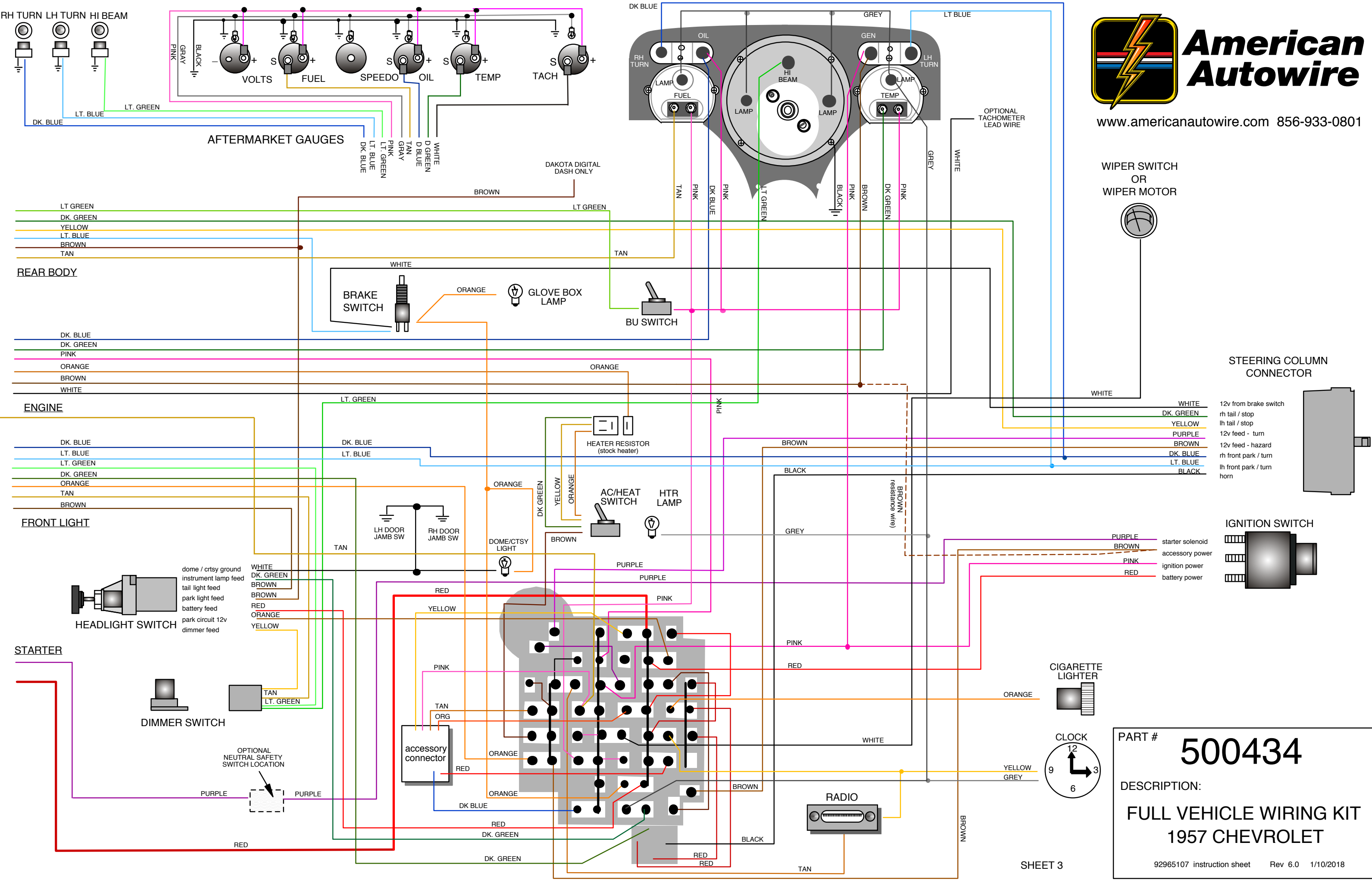

WIPER SWITCH
OR
WIPER MOTOR

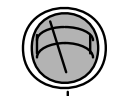

STEERING COLUMN
CONNECTOR

- WHITE 12v from brake switch
- DK. GREEN rh tail / stop
- YELLOW lh tail / stop
- PURPLE 12v feed - turn
- BROWN 12v feed - hazard
- DK. BLUE rh front park / turn
- LT. BLUE lh front park / turn
- BLACK horn

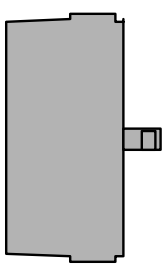

IGNITION SWITCH

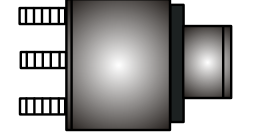

- PURPLE starter solenoid
- BROWN accessory power
- PINK ignition power
- RED battery power

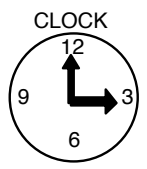

PART # **500434**

DESCRIPTION:
**FULL VEHICLE WIRING KIT
1957 CHEVROLET**

92965107 instruction sheet Rev 6.0 1/10/2018

**THIS PAGE HAS BEEN
INTENTIONALLY LEFT BLANK**



www.americanautowire.com 856-933-0801

PART # **500434**

DESCRIPTION:

**FULL VEHICLE WIRING KIT
1957 CHEVROLET**

92965107 instruction sheet Rev 6.0 1/10/2018