

NOTE: purple & yellow wires must be twisted together

Fuse Panel Installation Instructions

Following these simple instructions will guarantee a successful installation of your American Autowire Fuse Panel Harness.

The order of installation will be as follows:

1. Install the fuse box and mounting plate.
2. Route fuse panel harness in dash area.
3. Make all dash connections as shown in this Fuse Panel Installation sheet.
4. Starting with bag "H", install all other wiring bags as per the letter designation on instruction sheets. (bags H,J,K,L,M).

Let's begin your installation of this Fuse Panel harness. Study the diagram above, and follow the installation procedures on the following pages!

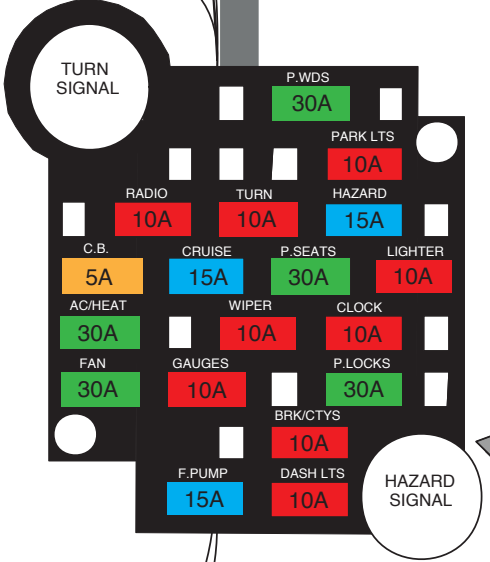

Fuse panel SEE SHEET 2

RECOMMENDED FUSE CIRCUIT RATINGS			
PARK LIGHTS	10 AMP	CRUISE	15 AMP
HAZARD	15 AMP	CLOCK	10 AMP
BRAKE LIGHTS	10 AMP	LIGHTER	10 AMP
DASH LIGHTS	10 AMP	FUEL PUMP	15 AMP
TURN SIGNAL	10 AMP	POWER SEAT	30 AMP
WIPER	10 AMP	POWER LOCK	30 AMP
GAUGE	10 AMP	POWER WINDOWS	30 AMP
C.B. RADIO	5 AMP		
A/C / HEATER	30 AMP		
RADIO	10 AMP		
FAN	30 AMP		



www.americanautowire.com 856-933-0801

PART # **500465** G

DESCRIPTION:
1947-55 Chevy/GMC Truck
 Custom Fuse Panel Harness
 92965204 Rev 8.0 8/21/2015 DB

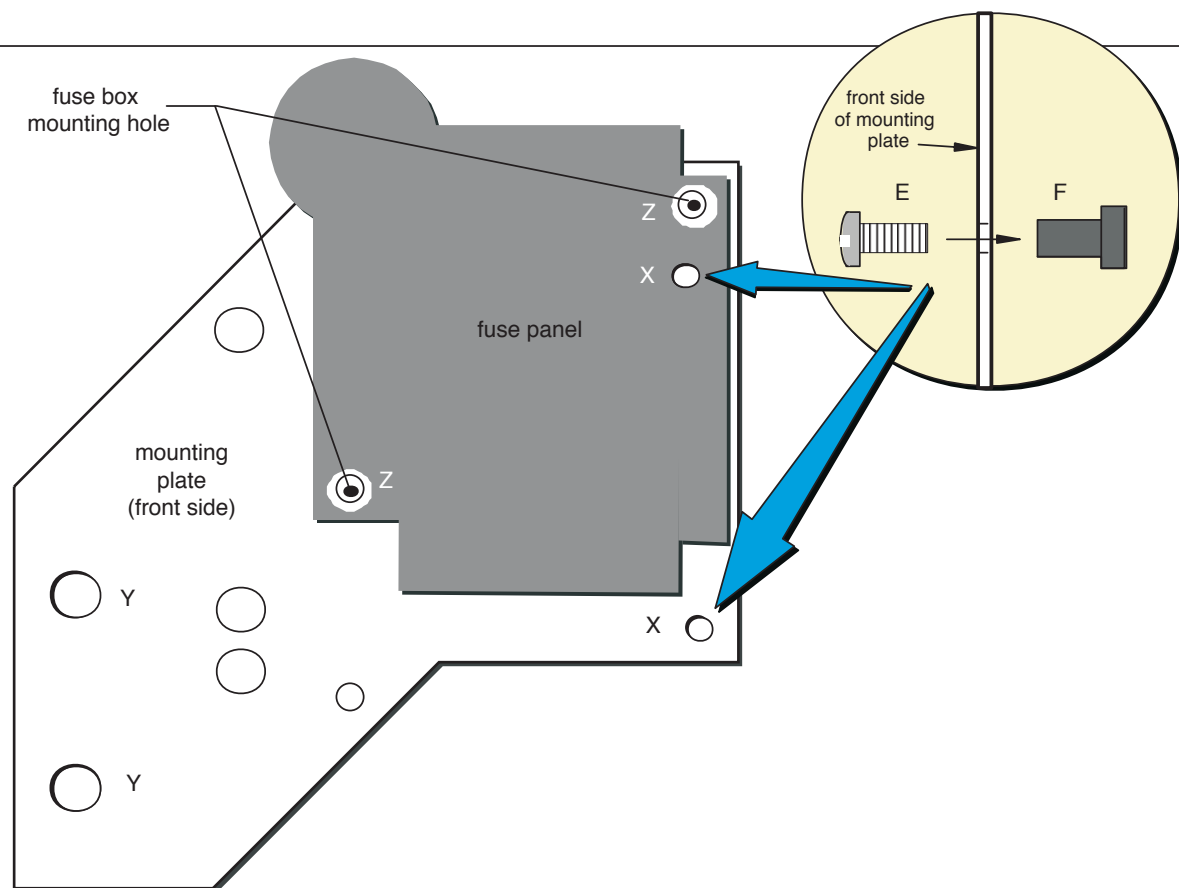

View from inside of firewall

DETAIL "A"

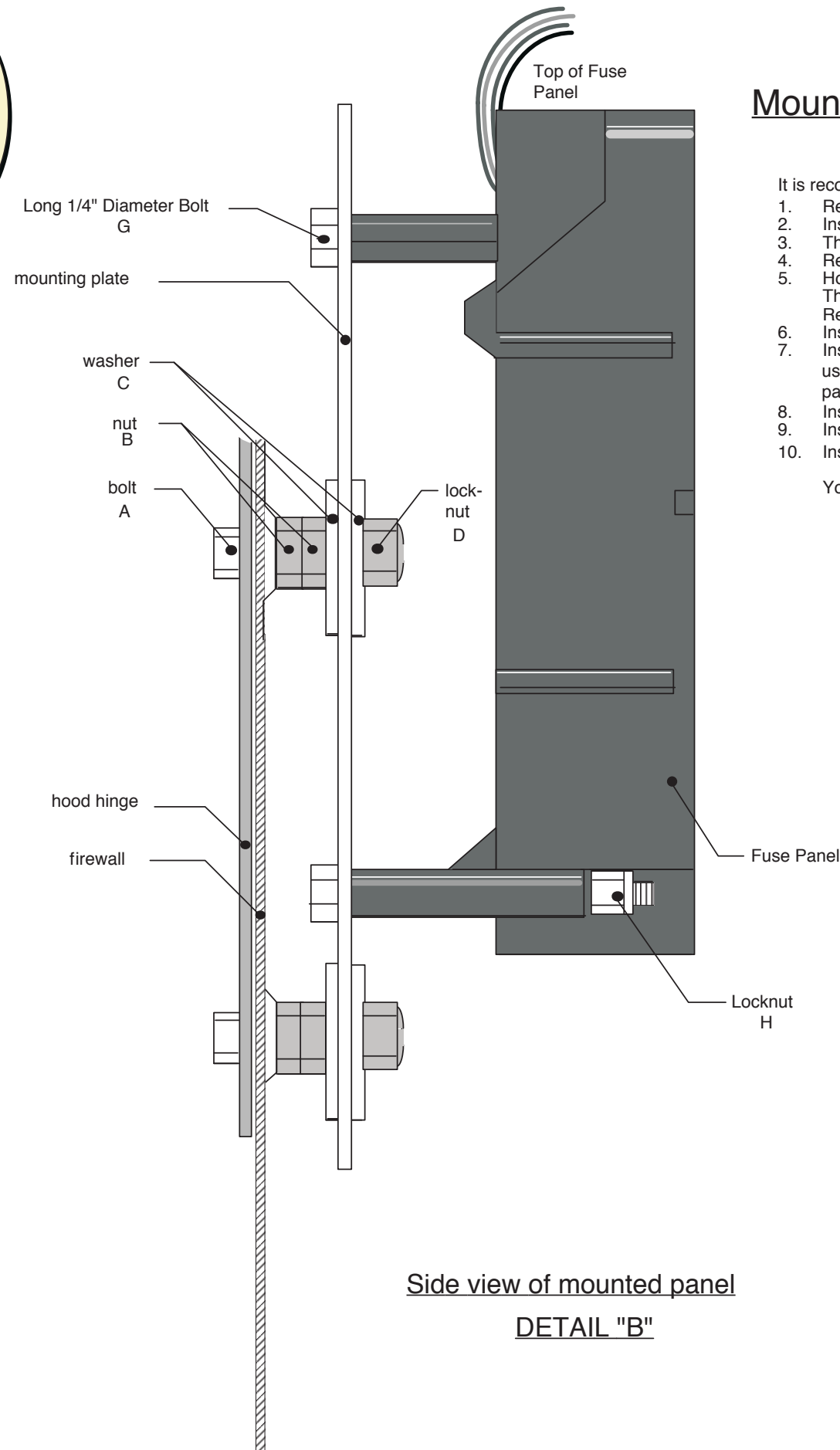
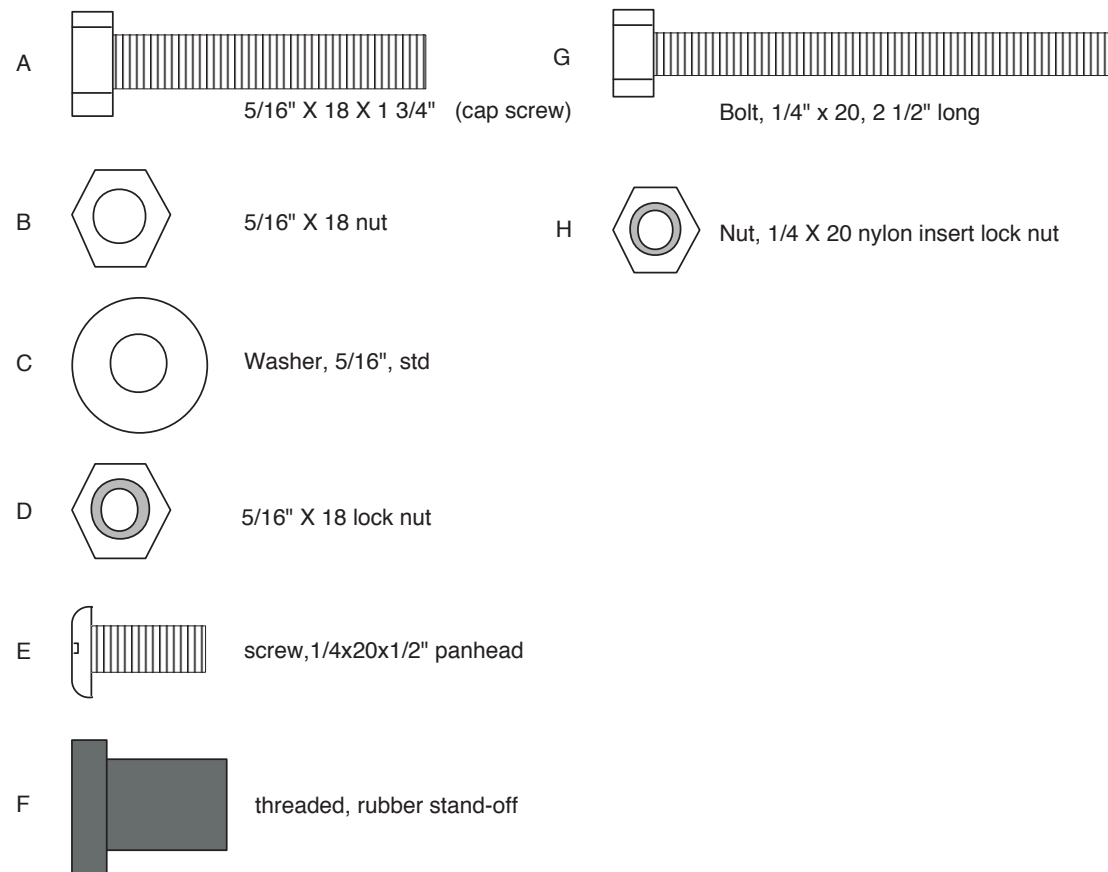

Side view of mounted panel

DETAIL "B"

Mounting Fuse Panel and mounting plate

It is recommended that the hood hinge bolts be replaced one at a time as follows:

1. Remove the upper driver-side, hood hinge spring bracket bolt from the firewall.
2. Install bolt "A" into the existing hood hinge spring bracket bolt hole.
3. Thread on 2 nuts "B" on each of bolt "A", as shown in detail "B".
4. Repeat for lower hinge bolt.
5. Holding the mounting plate as shown in detail "A", insert screw "E" into hole "X". Thread rubber standoff "F" onto screw "E", as shown. Repeat this procedure for the other hole marked "X".
6. Insert 2 bolts "G" into holes "Z", as shown in details "A"&"B".
7. Install fuse panel onto bolts "G", and secure using lock-nuts "H" (This is best done using a 1/4" drive, 6 point deep well socket and extension). Be sure to mount fuse panel as shown in detail "A"&"B", with the wires exiting the top of the fuse panel.
8. Install washer "C" on each bolt "A".
9. Install mounting plate assembly onto bolts "A", using holes "Y".
10. Install washer "C" and lock nut "D" to complete the plate installation.

Your fuse panel is now installed!



www.americanautowire.com 856-933-0801

1947-55 Truck
Custom Fuse Panel Harness **500465**

92965204 Rev 8.0 8/21/2015 DB

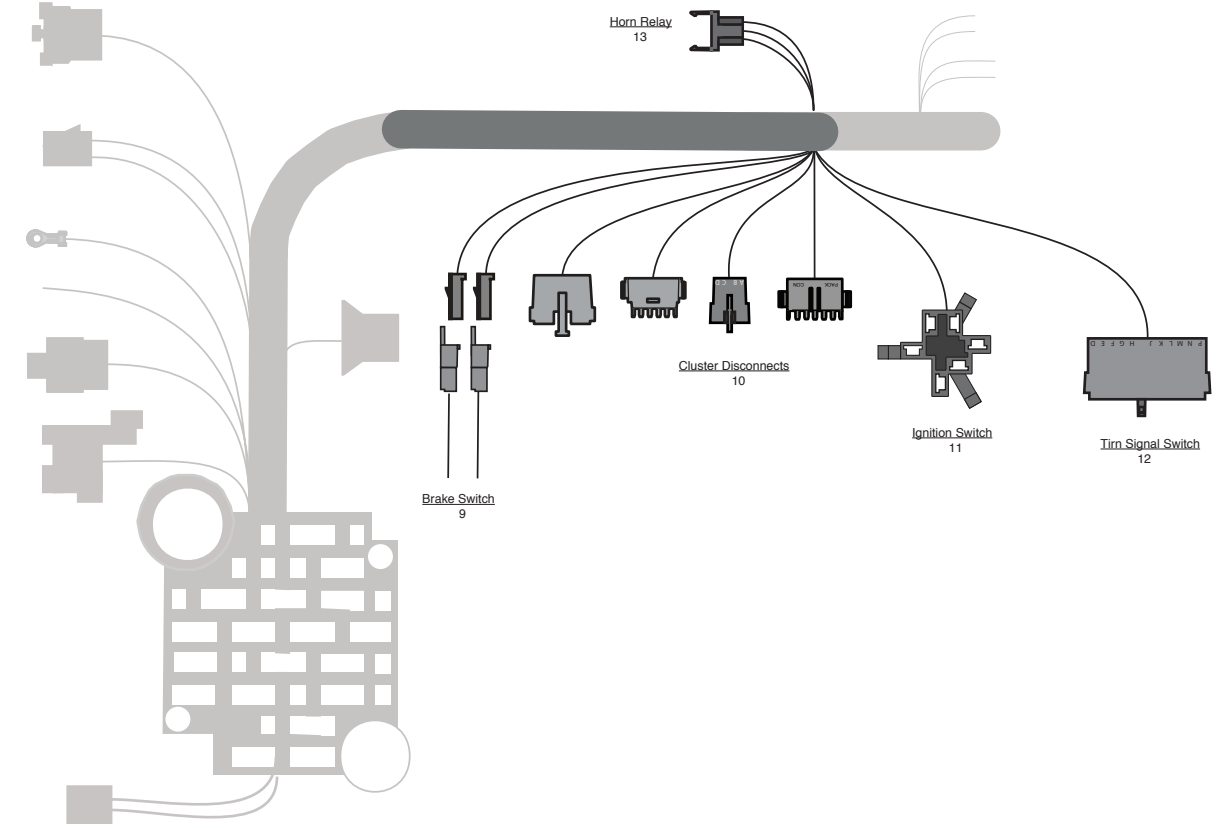
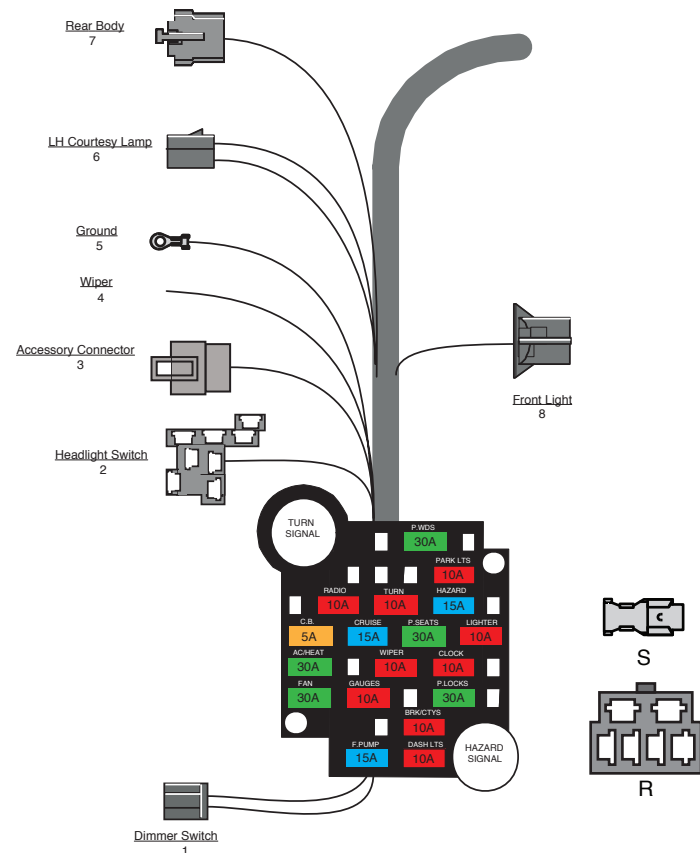

Note: Terminals are provided for most connections on your wiring kit. Use the provided terminals and connectors to install the following wires:

- | | | | |
|---|------------------|--|---|
| 1 | DIMMER SWITCH | Yellow
Tan
Lt Green | 12 volt feed to dimmer switch.
Low beam feed from dimmer switch to front light connector.
Hi beam feed from dimmer switch to front light connector and dash cluster indicator. |
| 2 | HEADLIGHT SWITCH | NOTE: On some trucks, it may be necessary to open up the round mounting hole in the dash a small amount to install the new AAW H/L Switch 500332
Orange
Brown
Yellow
Dk. Green
White | Secondary fused 12 volt battery feed to light switch for tail/parking lamp circuits, and output to dk. green dash lamp circuit.
Fused 12 volt feed out to tail and parking lamp circuits.
Feed out to dimmer switch for headlights.
12 volt feed out from light switch to fuse box for dash lamp circuit.
Ground lead for courtesy and dome lamp circuits. |
| 3 | ACCESSORIES | Use the provided connector R and terminals S if you wish to connect to the accessory connector.
Dark Blue
Orange
Red
Pink
Yellow
Tan | FUEL 15 amp Fused 12-volt IGNITION feed for fuel pump (may also be used to feed power to another ignition circuit).
P SEATS 30 amp Fused 12-volt BATTERY feed for power seats (may also be used to feed power to another battery circuit).
P LOCKS 30 amp Fused 12-volt BATTERY feed for power door locks (may also be used to feed power to another battery circuit).
CRUISE 15 amp Fused 12-volt IGNITION feed for cruise control (may also be used to feed power to another ignition circuit).
PWDOS 30 amp Fused 12-volt BATTERY feed for power windows (may also be used to feed power to another battery circuit).
CB 5 amp Fused 12-volt ACCESSORY feed (may also be used to feed power to an accessory circuit). |
| 4 | WIPER FEED | White | Fused 12 volt feed for windshield wipers. The dash switch will control the functions. For all aftermarket wiper systems, consult the manufacturers directions for installation. |
| 5 | CLUSTER GROUND | Black | This is the ground wire for the instrument cluster. Connect to a good known chassis ground (do not connect with #17 speedo ground). |
| 6 | LH COURTESY | This connector will mate to one of the courtesy lamp extensions (500472, bag N).
Orange
White | 12 volt feed to LH courtesy lamp.
Ground feed to LH courtesy lamp and LH door jamb switch. |
| 7 | REAR BODY | This connector will mate to the main rear body harness (510411, bag M) connector.
Tan
Brown
Yellow
Dk. Green
Orange
White
Lt. Green
Lt. Blue | Fuel tank sender wire.
Feed to the tail and license plate lamps.
Feed to LH stop and turn lamp.
Feed to RH stop and turn lamp.
Feed to dome and courtesy lamps.
Ground to dome and courtesy lamps.
Feed to back-up lamps.
Feed to third brake lamp. |
| 8 | FRONT LAMP | This connector will mate to the front lamp harness (500432, bag L).
Tan
Lt. Green
Brown
Lt. Blue
Dk. Blue
Dk. Green
Orange | Feed to lo beam H/L circuit.
Feed to hi beam H/L circuit.
Feed to LH and RH parking lamps.
Feed to LH turn signal lamp.
Feed to RH turn signal lamp.
Feed to horns.
Fused 12 volt ignition feed for electric fan relay (DO NOT CONNECT DIRECTLY TO ELECTRIC FAN). |

Note: Terminals are provided for most connections on your wiring kit. Use the provided terminals and connectors to install the following wires:

- | | | | |
|----|--------------------|--|--|
| 9 | BRAKE SWITCH | NOTE: We have set this harness up for a newer style brake switch that would mount up under the dash and use male blades. In the even that you are using a vintage style switch, we have provided orange and a white brake wire extensions that will allow you to extend the brake switch wires out to your switch. We have also included an instruction sheet (92965213) along with 2 types and terminals and connectors to help you make this connection.
Orange
White
Lt Blue | Fused 12 volt feed into brake switch
12 volt feed out of the brake switch to the turn signal switch for brake lights.
12 volt out of the brake switch to the rear body connection for the third brake light. |
| 10 | GAUGE DISCONNECT | These connectors will mate to the gauge cluster harness (510409, bag H) connectors. Wire identifications will be found in that kit. | |
| 11 | IGNITION SWITCH | This connector will mate to the new AAW ignition switch (510579).
Red
Pink
Brown
Purple | 12 volt unfused battery feed into the ignition switch.
12 volt unfused ignition feed out of the ignition switch to the fuse panel and engine harness connector.
12 volt unfused accessory feed out of the ignition switch to the fuse panel.
12 volt unfused starter solenoid feed out to the starter connection. |
| 12 | TURN SIGNAL SWITCH | Plug into steering column turn signal connection. If you are using a stock '47-'55 truck steering column in your truck, please refer to "Table A - AAW Turn Signal Switch wires to stock 1947-55 Chevy & GMC Truck turn signal switch" on page 4, for proper mating directions. Our connector mates to a 3 7/8 inch long plug used on 1969-1976 GM, IDIDIT, and many other aftermarket steering columns. Starting from 1977 on up, the GM switch changed and began using a 4 1/4 inch connector. That connector is from the same family and uses the same terminals. By using the supplied mating connector and terminals located in the loose piece kit bag of the dash harness (500465, bag G), it is easy to adapt any steering column to this kit. The function of the wires are as follows:
White
Dk. Green
Yellow
Purple
Brown
Dk. Blue
Lt. Blue
Black | 12 volt feed into the turn signal switch from the brake switch for your brake lights.
Feed out of the turn signal switch to the rear body connector for the RH rear turn signal.
Feed out of the turn signal switch to the rear body connector for the LH rear turn signal.
12 volt ignition feed into the turn signal switch for turn signals.
12 volt battery feed into the turn signal switch for hazard lamps.
Feed out of the turn signal switch to the front light and cluster connectors for the RH front turn signal.
Feed out of the turn signal switch to the front light and cluster connectors for the RH front turn signal.
Horn relay ground wire from horn switch to horn relay connector. |
| 13 | HORN RELAY | Red
Black
Dk. Green | Plug the horn relay (found in the fuse, relay, and flasher bag, 510565) into this connector.
12 volt battery for relay.
Relay ground circuit from steering column horn switch.
Triggered 12 volt feed from the relay to the front lamp connector for the horns. |



www.americanautowire.com 856-933-0801

1947-55 Truck Custom Fuse Panel Harness	500465
92965204 Rev 8.0 8/21/2015 DB	

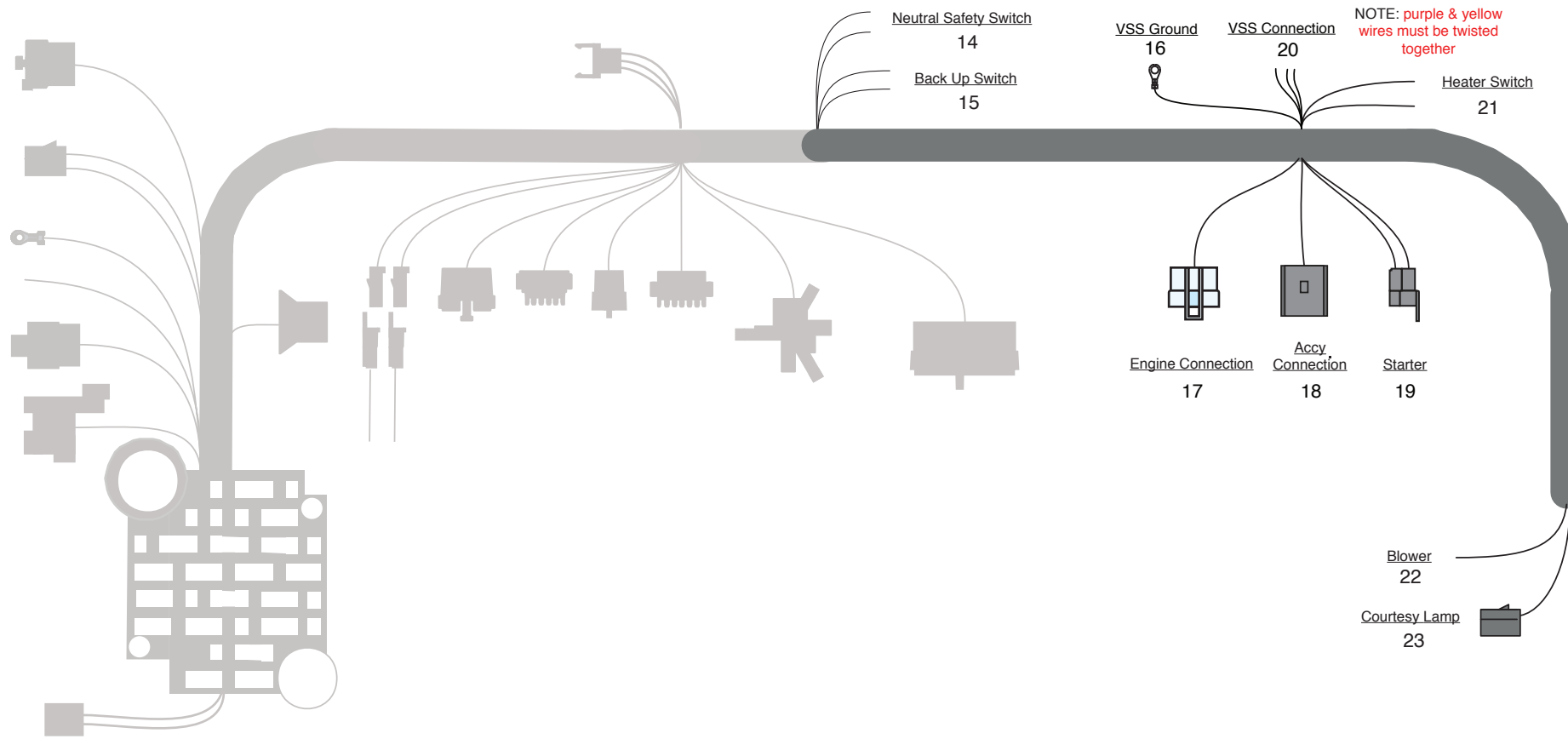

“Table A” AAW Turn Signal Switch wires to stock 1947-55 Chevy & GMC Truck turn signal switch.

AAW Wire #	AAW Wire color	AAW Wire Printing	Stock Truck Wire Color
14A,B	Light Blue	Left Front Turn	Light Blue
15A,B	Dark Blue	Right Front Turn	Dark Blue
16B	Purple	Turn Switch Feed	Yellow
17A,B	Blue & White	Brake Switch	White
18	Yellow	Left Rear Turn	Pink
19	Dark Green	Right Rear Turn	Purple
27B	Brown	Turn Sw - Hazard	Not applicable
28	Black	Horn Relay Ground	Black, Tan, or Dk. Green

NOTE: The stock 1947-55 Truck turn signal switches did not have a horn ground wire located in them. That wire was a separate wire that was attached to the steering column upper mast jacket bushing and came out through an opening in the steering column. That wire was typically black, tan, or dark green and had a small male blade crimped onto it. If you are using the factory steering column in your car, crimp one of the loose piece terminals “M” found in the loose piece kit of the 500465 dash harness onto that wire, and plug it into the adapter “L” when building your turn signal switch adapter to complete the horn ground circuit.

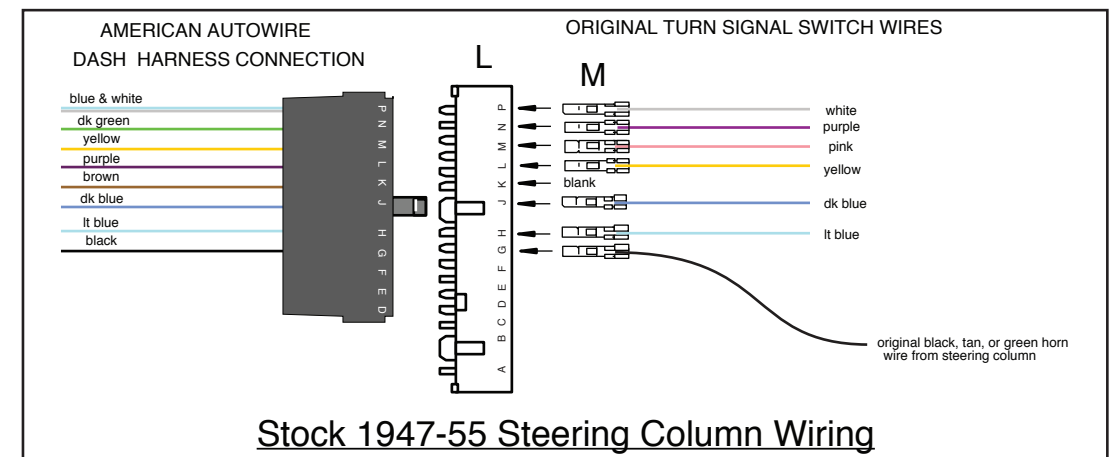

Note: Terminals are provided for most connections on your wiring kit. Use the provided terminals and connectors to install the following wires:

- 14 NEUTRAL SAFETY SW **NOTE: These wires MUST be connected to either a neutral safety switch if using an automatic transmission, or connected together if using a manual transmission in order for the starter to operate, and for the truck to start.**
 Purple 12 volt feed from the ignition switch to the neutral safety switch.
 Purple 12 volt feed from the neutral safety switch to the starter connection for the starter solenoid.
- 15 BACK UP SWITCH
 Pink 12 volt fused feed from the fuse box to the back up lamp switch.
 Lt. Green 12 volt feed from the back up lamp switch to the rear body connector for the back up lamps.
- 16 ELECTRIC SPEEDO GROUND
 Black/White St. This is the ground wire for the electric speedometer. Connect to a good known chassis ground (**do not connect with #5 cluster ground**).
- 17 ENGINE
 This connector will mate to the engine harness (510405, bag J) 6-position connector. Wire identifications will be found in that kit.
- 18 ACCESSORY CONN. **NOTE:** We have supplied you with a mating connector and 5 loose piece terminated wires that can be used to plug into this connection. Below you will find a table with the wire colors, our suggested use, and how each wire is circuited (battery or accessory fused). This connector can be used for many different functions. For example, if you do not need a glove box lead, but have a need for a separate battery fused feed wire, the orange glove box wire may be used to supply power to that item. Install any needed wires into the mating connector maintaining color continuity with the dash side wires in connector #19, then connect the loose end of the wire to your item.
 Red Cigarette lighter - battery fused.
 Yellow Radio battery 12 volt - battery fused lead for radio memory.
 Orange Glove box feed - battery fused
 Gray Heater control lamp - Fused lighting switch controlled lamp feed wire (can be used for any dash lamp needs).
 Tan Radio power - Switched “off/on” accessory fused power feed wire for radio.
- 19 STARTER
 This connector will mate to the engine harness (510405, bag J) 3-position connector. Wire identifications will be found in that kit.
- 20 VSS CONNECTIONS
 These wires will only be used if you are using an electronic speedometer. Route these wires out through the split grommet in the firewall with the engine and starter connections from above, and down to the VSS on your transmission. (**NOTE: The purple and yellow wires must remain twisted together down to the speed sensor unit.**) See the gauge cluster kit instructions, 510409 bag H, for typical connections.
 Purple VSS signal. This wire will attach to the signal wire on your VSS (twister together with the yellow wire from below).
 Yellow VSS ground. This wire will attach to the ground wire on your VSS (twister together with the purple wire from above).
 Purple/White St. 12 volt fused feed to the VSS. This wire will attach to the 12 volt wire on your VSS (only used with a 3 wire VSS).
- 21 HEATER SWITCH
 Brown 12 volt fused accessory feed to heater/A-C switch. (**NOTE: This is also the “key on” power feed for any aftermarket heater or A/C system.**)
 Orange 12 volt feed out of the switch to the blower motor.
- 22 HEATER BLOWER
 Orange 12 volt feed from heater switch to blower motor (used only with stock heater switch and blower assembly).
- 23 RH COURTESY
 This connector will mate to one of the courtesy lamp extensions (500472, bag N).
 Orange 12 volt feed to RH courtesy lamp.
 White Ground feed to RH courtesy lamp and RH door jamb switch.



www.americanautowire.com 856-933-0801

1947-55 Truck
Custom Fuse Panel Harness **500465**
92965204 Rev 8.0 8/21/2015 DB