

Classic Update Series

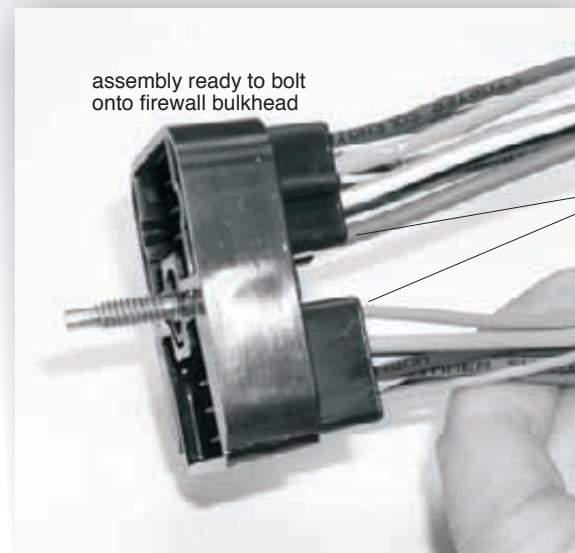

The bulkhead connector from this front light kit must snap into the mating engine connector (bag J), as shown. After snapping together, then bolt the assembly into the dash harness firewall connector using the attached bolt.

Look!

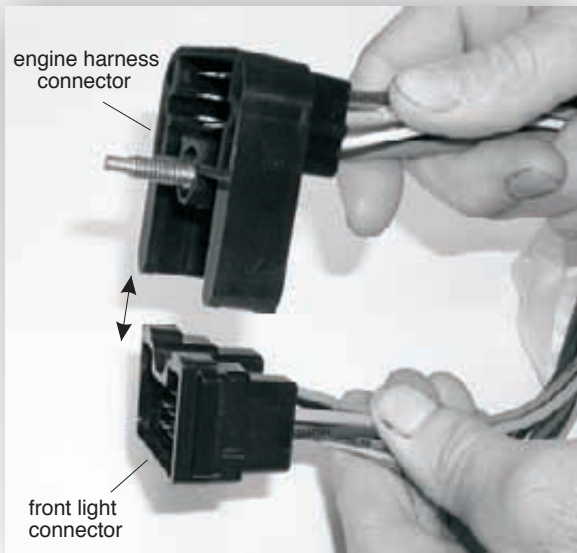

American Autowire also sells factory OEM style harness wrap. this is the same stuff used on original Camaro harnesses! If you want that OEM look with your Classic Update wiring system, then give us a call and order p/n R0067108 !



**American
Autowire**

www.americanautowire.com 856-933-0801





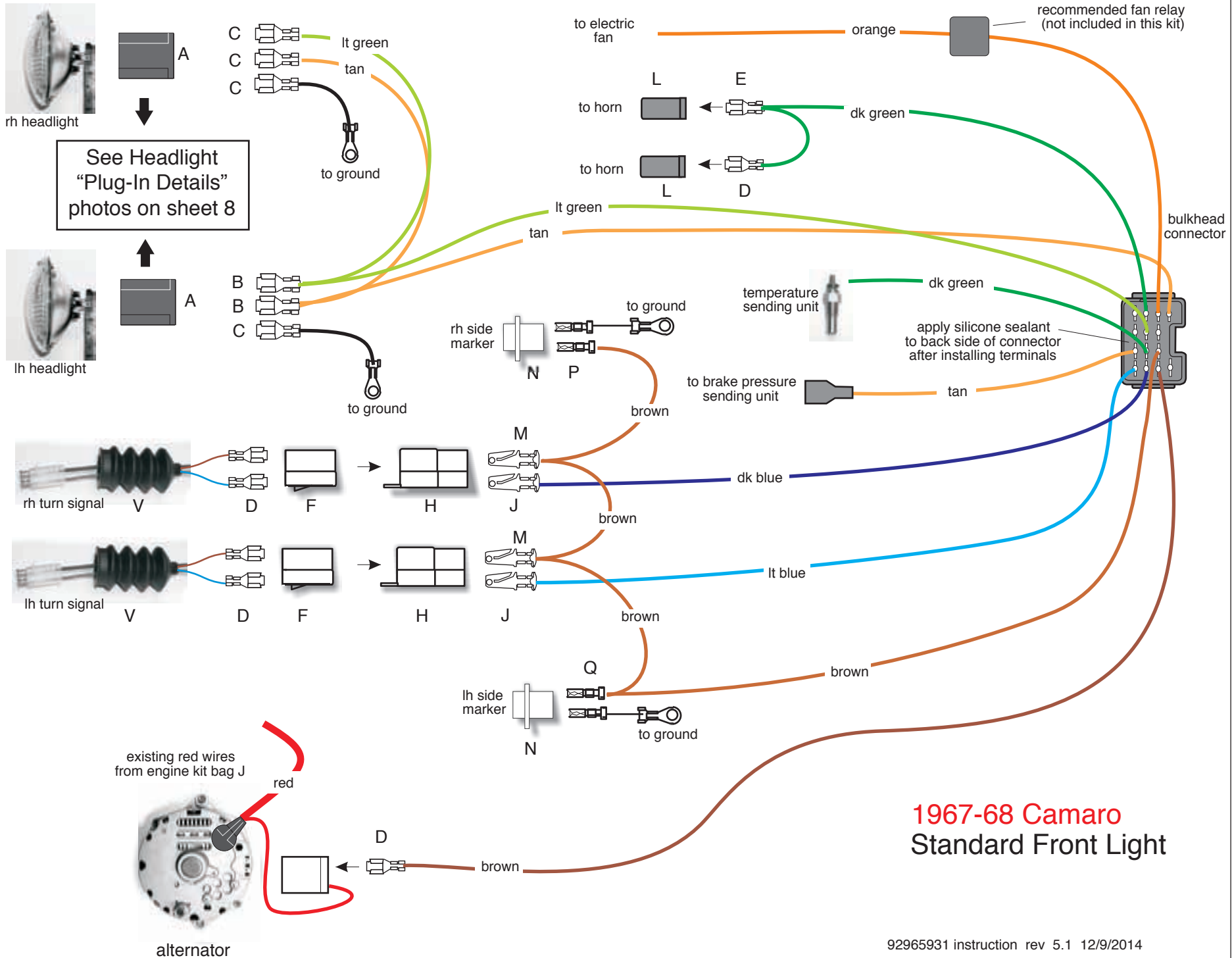













Classic Update Series



1967-68 Camaro
Standard Front Light

1967-68 Camaro Standard Front Lighting

A		Connect the bulkhead connector from this kit onto the bulkhead connector from the engine kit (bag J), and bolt to the firewall dash bulkhead.	
B		<u>PARKING LAMP WIRES</u>	
C		LT BLUE	LH turn
D		DK BLUE	RH turn
E		BROWN	Parking Lamp
F		Route this wire to the LH side marker lamp and cut to length. Double this wire with the cut off portion, install terminal Q, and plug into lamp socket N, as shown on sheet 2. (Also plug the pre-assembled black ground wire into lamp socket N, as shown on sheet 2.) Route the remaining portion of the brown wire to the LH turn signal lamp and cut to length. Double this wire with the cut off portion, install terminal M, and plug into connector H with the lt blue wire from above as shown on sheet 2. Route the remaining portion of the brown wire to the RH turn signal lamp and cut to length. Double this wire with the cut off portion, install terminal M, and plug into connector H with the dk blue wire from above as shown on sheet 2. Route the remaining brown wire to the RH side marker and trim to length. Install terminal P and plug into connector N, as shown on sheet 2. (Also plug the pre-assembled black ground wire into lamp socket N, as shown on sheet 2.)	
H			
J			
V			
<u>NOTE:</u> We have provided parking lamp pigtails V (500737) for you to install into your standard Camaro parking lamp assemblies. Install terminals D and connectors F onto each pigtail assembly, as shown on sheet 2, (maintaining color continuity with connector H from above), then plug into connector H to complete your parking lamp circuits.			
<u>FRONT LIGHT WIRING</u>			
		TAN (heavy gauge)	Lo Beam
		LT GREEN	Hi Beam
L		BLACK	Ground
M		DK GREEN	Horn
		ORANGE	Electric Fan
<u>NOTE:</u> We recommend that this wire be used as the trigger wire for the electric fan relay. American Autowire manufactures relay kits for this application!			
N		TAN (small gauge)	Brake Sender
P		DK GREEN	Water Temp
Q		BROWN	Alternator Regulator
<u>NOTE:</u> This wire is only used on an alternator with an internal regulator which requires an exciter wire. If you are using a true one wire alternator, then this brown wire will not used and can be removed.			
R			
S			

Classic Update Series

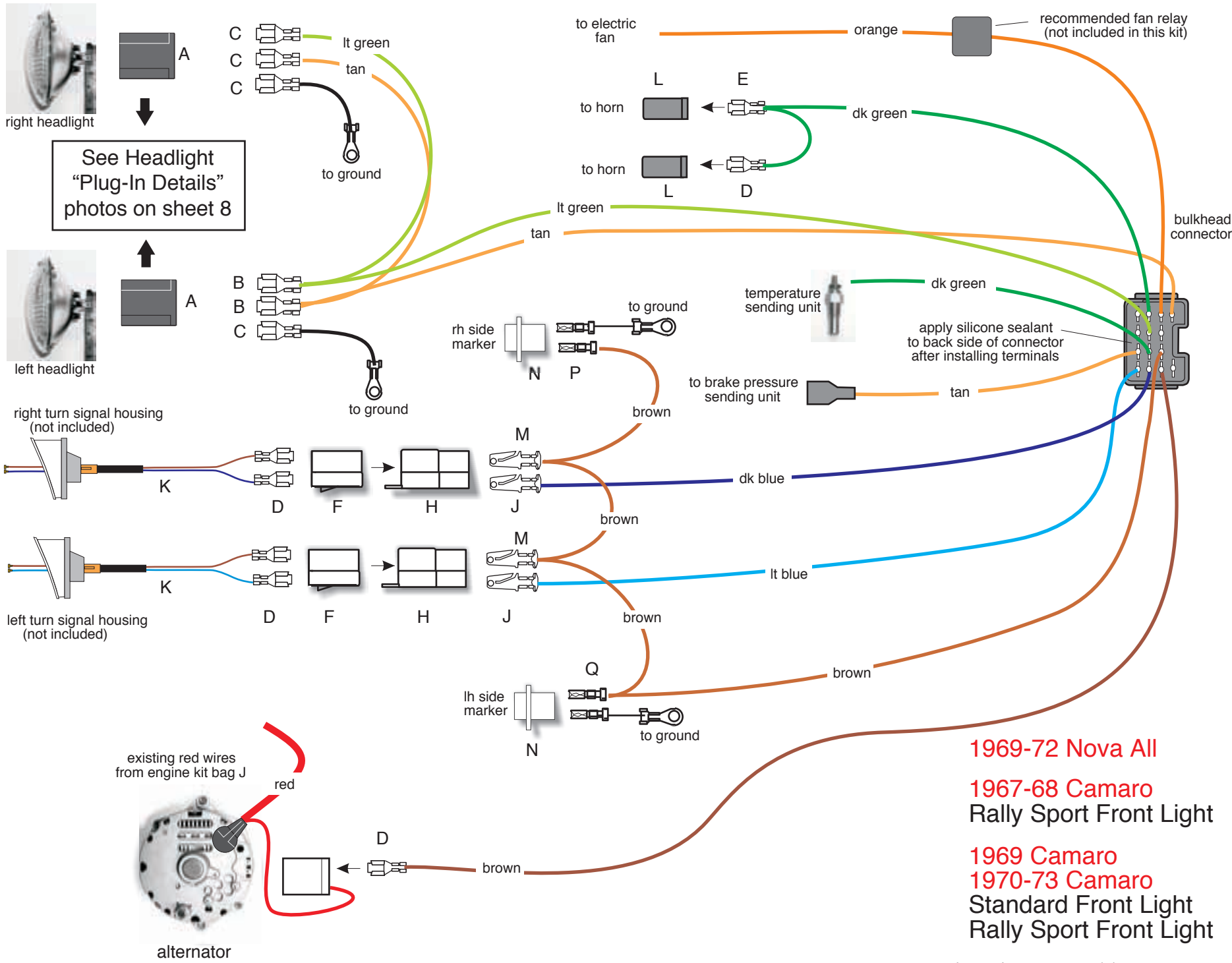

1969-72 Nova All
 1967-68 Camaro Rally Sport Front Light
 1969 Camaro Standard Front Light
 1970-73 Camaro Rally Sport Front Light

1967-68 Camaro Rally Sport Front Lighting; 1969-72 Nova Front Lighting 1969 Camaro & 1970-73 Camaro Standard and Rally Sport Front Lighting

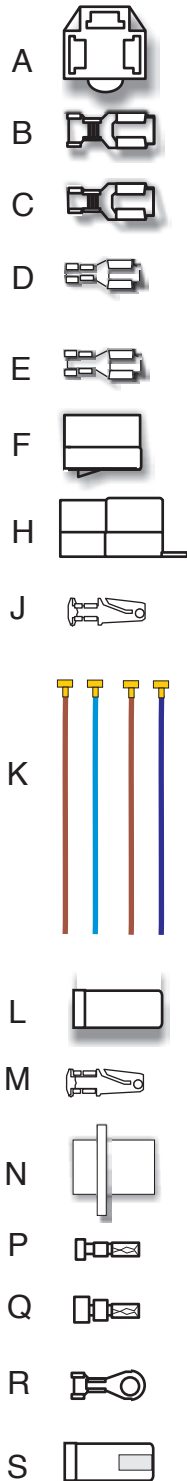

Connect the bulkhead connector from this kit onto the bulkhead connector from the engine kit (bag J), and bolt to the firewall dash bulkhead.

PARKING LAMP WIRES

C	LT BLUE	LH turn	Route this wire to the LH turn signal lamp install terminal J, and plug into connector H as shown on sheet 4.
D	DK BLUE	RH turn	Route this wire to the RH turn signal lamp install terminal J, and plug into connector H as shown on sheet 4.
E	BROWN	Parking Lamp	Route this wire to the LH side marker lamp and cut to length. Double this wire with the cut off portion, install terminal Q, and plug into lamp socket N, as shown on sheet 4. (Also plug the pre-assembled black ground wire into lamp socket N, as shown on sheet 4.) Route the remaining portion of the brown wire to the LH turn signal lamp and cut to length. Double this wire with the cut off portion, install terminal M, and plug into connector H with the lt blue wire from above as shown on sheet 4. Route the remaining portion of the brown wire to the RH turn signal lamp and cut to length. Double this wire with the cut off portion, install terminal M, and plug into connector H with the dk blue wire from above as shown on sheet 4. Route the remaining brown wire to the RH side marker and trim to length. Install terminal P and plug into connector N, as shown on sheet 4. (Also plug the pre-assembled black ground wire into lamp socket N, as shown on sheet 4.)

NOTE: The running and directional light assemblies use factory parking lamp housing assemblies. To connect them, plug completed connector H (on the wires above) onto the factory parking lamp housing assemblies as shown on sheet 4. Replacement wires K, terminals D, and connectors F are provided in the event that the wiring in your factory assemblies need repair. Repeat for both front parking lamps.

FRONT LIGHT WIRING

K	TAN (heavy gauge)	Lo Beam	Route this wire to the driver side headlight and trim to length. Double this wire with the cut off portion, and install terminal B. Plug this terminal into connector A, in the location shown on sheet 8. Route the remaining portion of this tan wire to the passenger headlight and trim to length. Install terminal C and connector A, in the location shown on sheet 8.
L	LT GREEN	Hi Beam	Route this wire to the driver side headlight and trim to length. Double this wire with the cut off portion, and install terminal B. Plug this terminal into connector A, in the location shown on sheet 8. Route the remaining portion of this lt green wire to the passenger headlight and trim to length. Install terminal C and connector A, in location shown on sheet 8.
M	BLACK	Ground	Install terminal C and plug into connector A, in the location shown on sheet 8. Connect the ring terminal to a good chassis ground. Complete for each headlight.
N	DK GREEN	Horn	Route to horns and install terminals D & E, as shown on sheet 4, Plug into connectors L.
	ORANGE	Electric Fan	Route to the electric fan, and connect per manufacturer's instructions.

NOTE: We recommend that this wire be used as the trigger wire for the electric fan relay. American Autowire manufactures relay kits for this application!







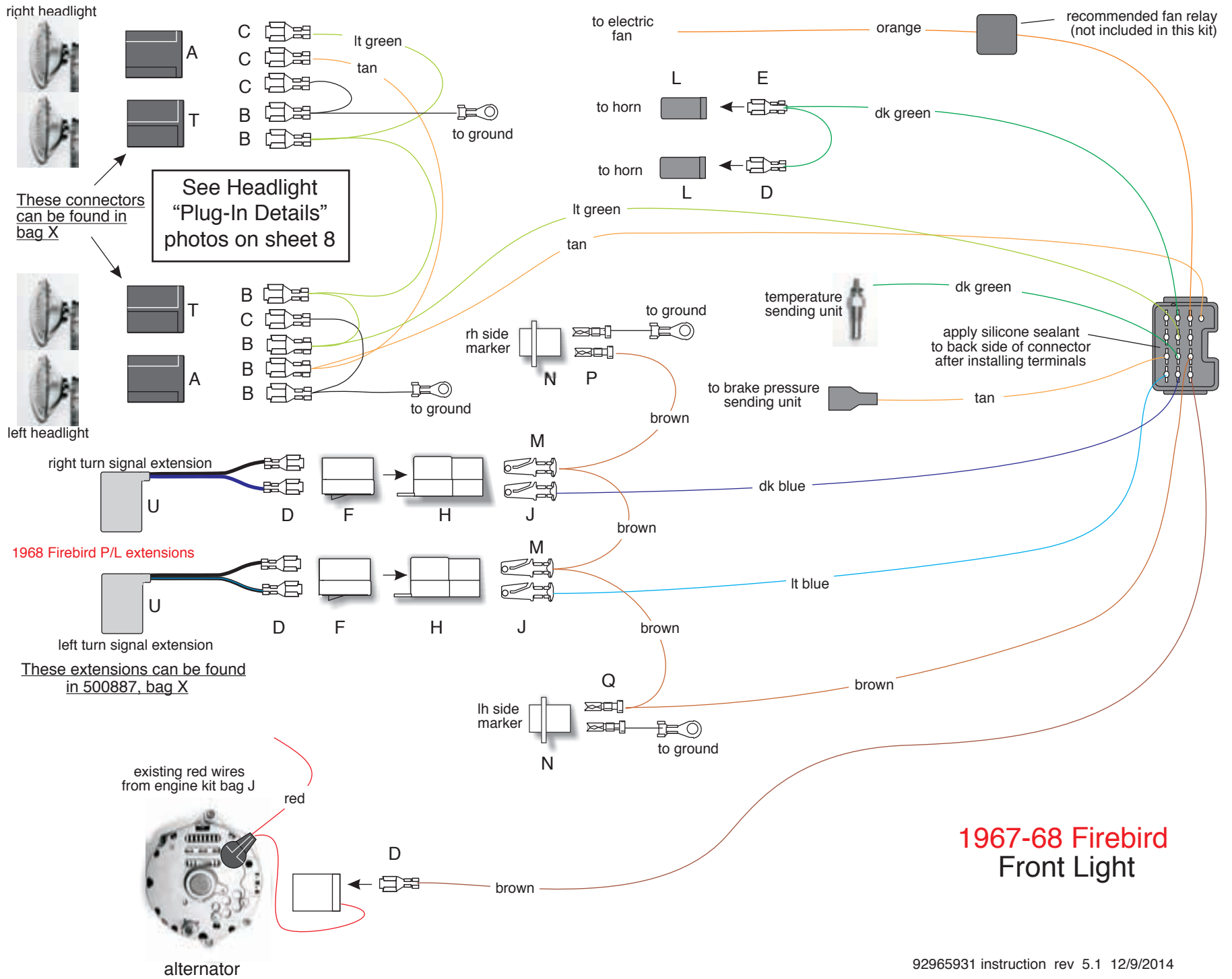









P	TAN (small gauge)	Brake Sender	Plug this wire onto the stock brake sender switch.
Q	DK GREEN	Water Temp	Connect this wire to the temperature sending unit using terminal R or terminal D and connector S (depending on your sending unit).
R	BROWN	Alternator Regulator	Route this wire to the alternator and cut to length. Install terminal D and plug into the regulator connector (previously installed from the engine kit 500668 bag J).

NOTE: This wire is only used on an alternator with an internal regulator which requires an exciter wire. If you are using a true one wire alternator, then this brown wire will not used and can be removed.

Classic Update Series



1967-68 Firebird Front Lighting

A				Connect the bulkhead connector from this kit onto the bulkhead connector from the engine kit (bag J), and bolt to the firewall dash bulkhead.
B				
<u>PARKING LAMP WIRES</u>				
C		LT BLUE	LH turn	Route this wire to the LH turn signal lamp install terminal J, and plug into connector H as shown on sheet 6.
D		DK BLUE	RH turn	Route this wire to the RH turn signal lamp install terminal J, and plug into connector H as shown on sheet 6.
E		BROWN	Parking Lamp	Route this wire to the LH side marker lamp and cut to length. Double this wire with the cut off portion, install terminal Q, and plug into lamp socket N, as shown on sheet 6. (Also plug the pre-assembled black ground wire into lamp socket N, as shown on sheet 6.) Route the remaining portion of the brown wire to the LH turn signal lamp and cut to length. Double this wire with the cut off portion, install terminal M, and plug into connector H with the lt blue wire from above as shown on sheet 6. Route the remaining portion of the brown wire to the RH turn signal lamp and cut to length. Double this wire with the cut off portion, install terminal M, and plug into connector H with the dk blue wire from above as shown on sheet 6. Route the remaining brown wire to the RH side marker and trim to length. Install terminal P and plug into connector N, as shown on sheet 6. (Also plug the pre-assembled black ground wire into lamp socket N, as shown on sheet 6.)
F				
H				
J				
L				
M				
<u>NOTE:</u> The running and directional light assemblies on all 1968 Firebirds utilize a unique connection assembly. We have provided you with two pigtails U (500887, bag X) to plug onto your factory assemblies. The black/black-light blue is for your driver side lamp (LH), and the black/dark blue is for the passenger side lamp (RH). Plug these pigtails onto your lamp assemblies, trim the wires to length, install terminals D and plug into connector F as shown on sheet 6. Plug completed pigtail assemblies U with connector F installed on them onto connectors H as shown on page 6 to complete your front parking lamp circuits. The running and directional light assemblies on all 1967 Firebirds will simply plug onto the completed connectors H from above.				
<u>FRONT LIGHT WIRING</u>				
N		TAN (heavy gauge)	Lo Beam	Route this wire to the driver side outer headlight and trim to length. Double this wire with the cutoff portion, and install terminal B. Plug this terminal into connector A, in the location shown on sheet 8. Route the remaining portion of this tan wire to the passenger side outer headlight and trim to length. Install terminal C and plug into connector A as shown on sheet 8.
P				
Q		LT GREEN	Hi Beam	Route this wire to the driver side outer headlight and trim to length. Double this wire with the cutoff portion, and install terminal B. Plug this terminal into connector A, make a short jumper over to the driver side inner headlight, cut to length, double it with the cutoff portion, install terminal B, and plug it into connector T in the location shown on sheet 8. Route the remaining portion of this lt green wire to the passenger side inner headlight and trim to length. Double this wire with the cutoff portion, install terminal B and plug into connector T as shown on sheet 8. Make a short jumper over to the passenger side outer headlight, cut to length, double it with the cutoff portion, install terminal C, and plug it into connector A in the location shown on sheet 8.
R				
S				
T		BLACK	Ground	Route this wire to the driver side outer headlight and trim to length. Double this wire with the cutoff portion, and install terminal B. Plug this terminal into connector A, take the short jumper over to the driver side inner headlight, cut to length, install terminal C, and plug it into connector T in the location shown on sheet 8. Repeat this process for the passenger side.
U		DK GREEN	Horn	Route to horns and install terminals D & E, as shown on sheet 6, Plug into connectors L.

1967-68 Firebird Front Lighting

ORANGE	Electric Fan	Route to the electric fan, and connect per the manufacturers instructions. <u>NOTE:</u> We recommend that this wire be used as the trigger wire for the electric fan relay. American Autowire manufactures relay kits for this application.
TAN (small gauge)	Brake Sender	Plug this wire into the stock brake sender switch.
DK GREEN	Water Temp	Connect this wire to the temperature sending unit using terminal R or terminal D and connector S (depending on your sending unit).
BROWN	Alternator Regulator	Route this wire to the alternator and cut to length. Install terminal D and plug into the regulator connector (previously installed from the engine kit 500668 bag J). <u>NOTE:</u> This wire is only used on an alternator with an internal regulator which requires an exciter wire. If you are using a true one wire alternator, then this brown wire will not used and can be removed.

After all wires are installed from this kit, the main connector should have die-electric grease applied to the terminals. Also, to assure a moisture resistance seal, apply silicone sealant to the outside of the main connector around each wire.

Headlight Connector “Plug-In Details”



1967-73 Camaro All
1968-72 Nova All

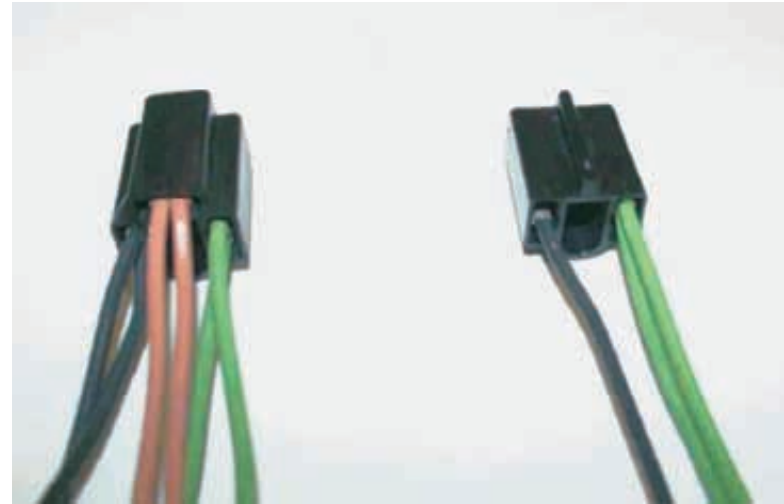

1967-68 Firebird (only)