

Depicted on this page is the 500687 R/S Main Harness Assembly



## CONNECTION TO LIMIT SWITCHES

- If using after market limit switches, connect as shown in DIAGRAM "A"
- If using original GM limit switches, connect as shown in DIAGRAM "B".

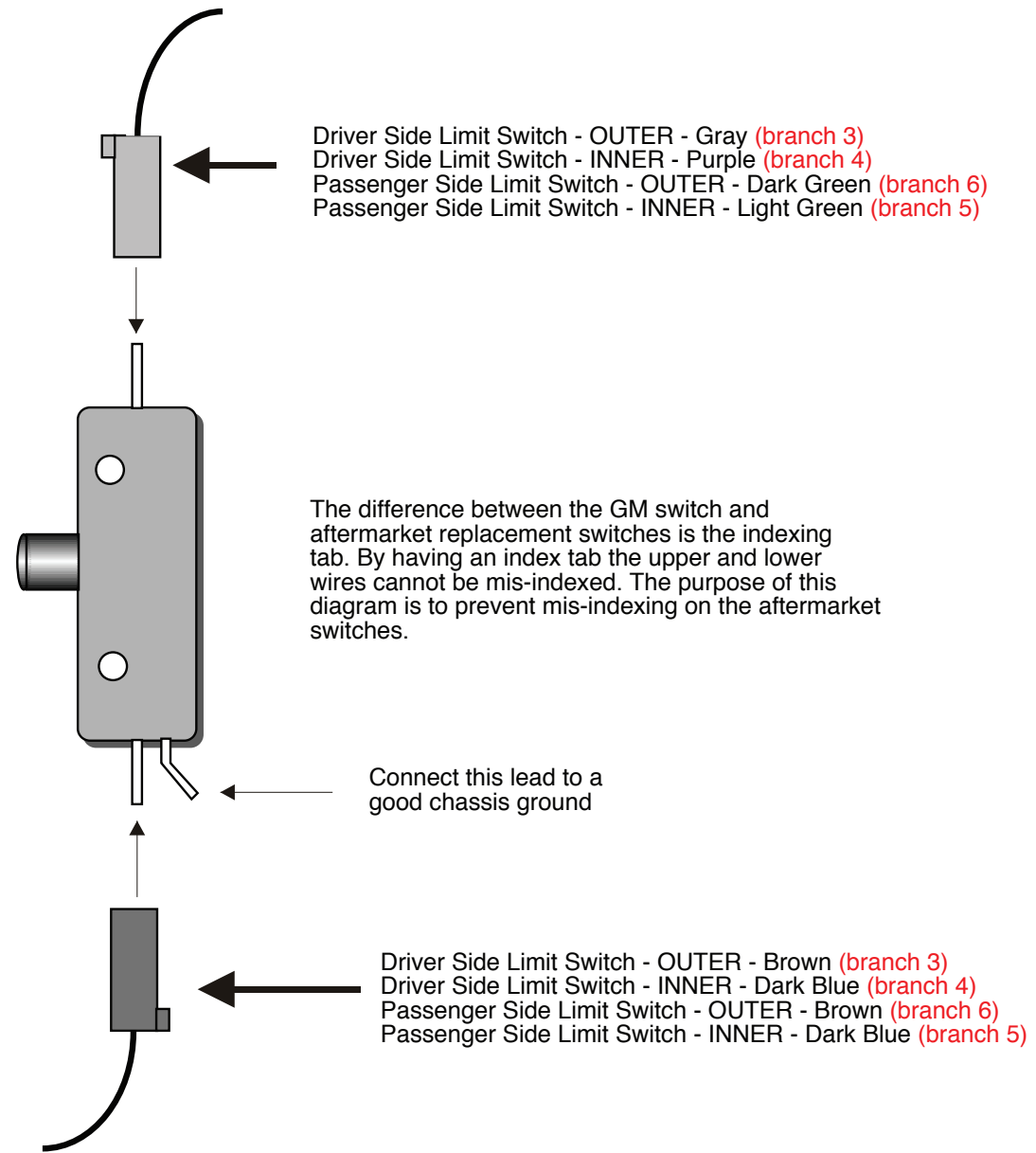

DIAGRAM "A"

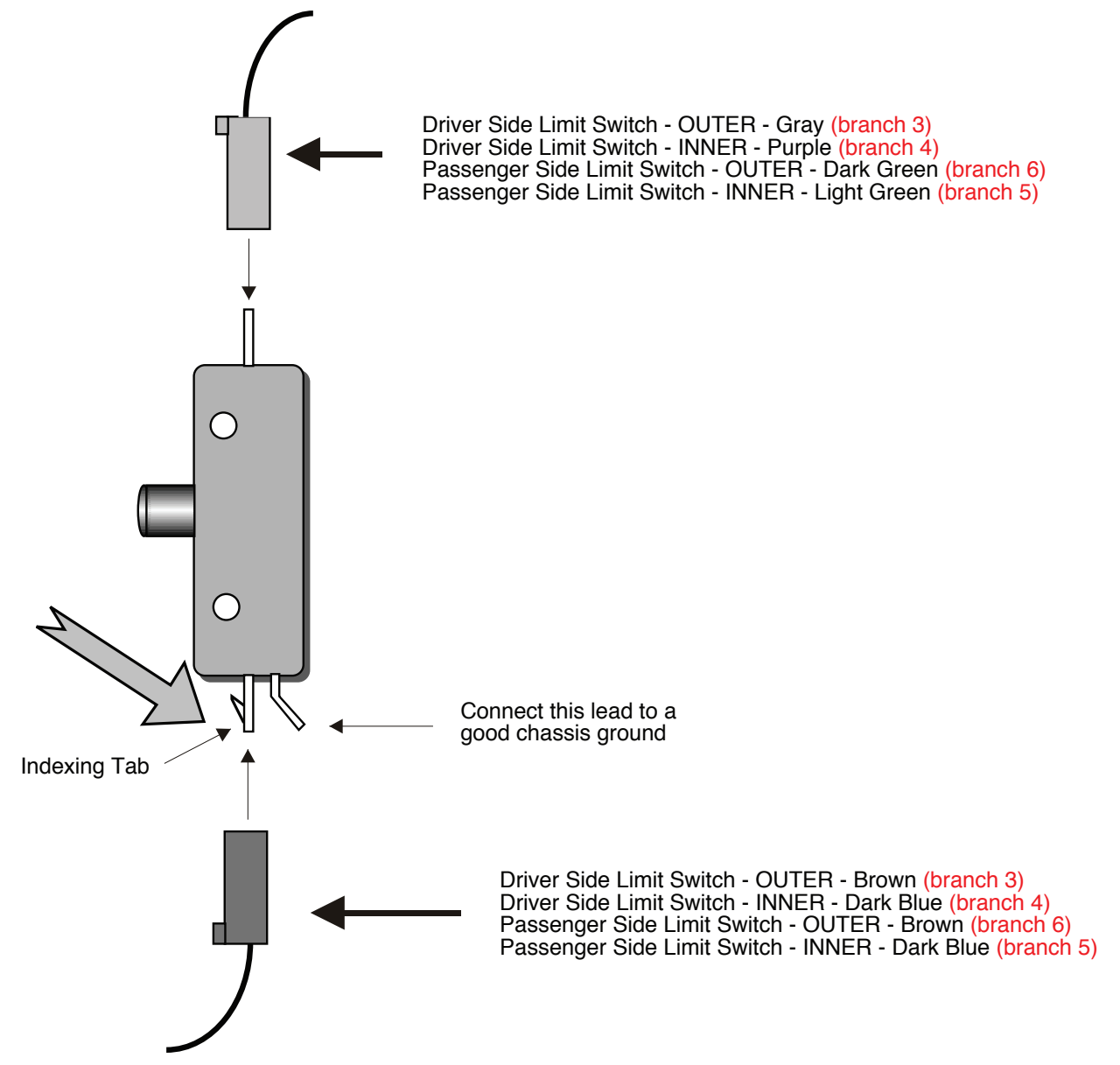
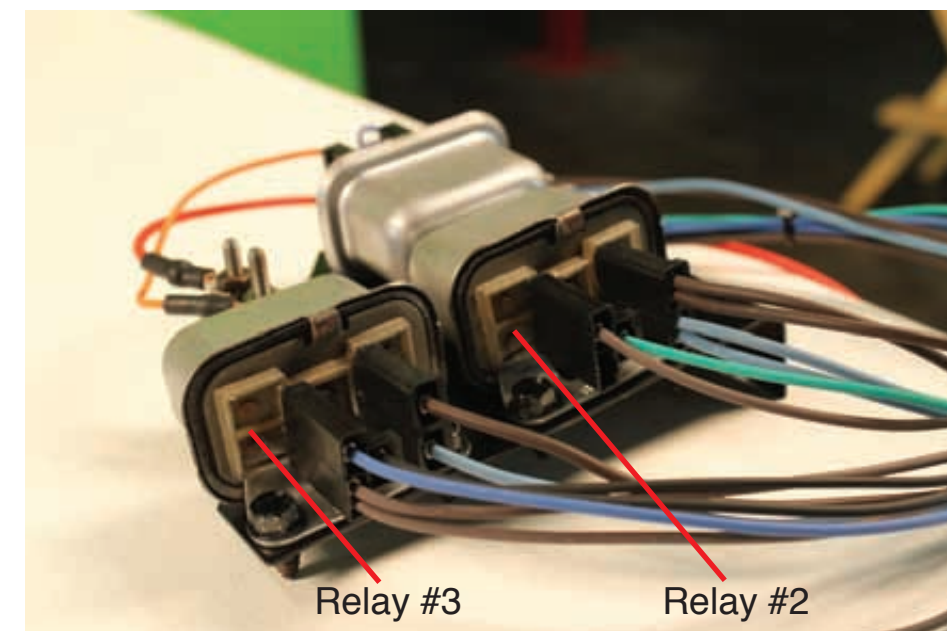
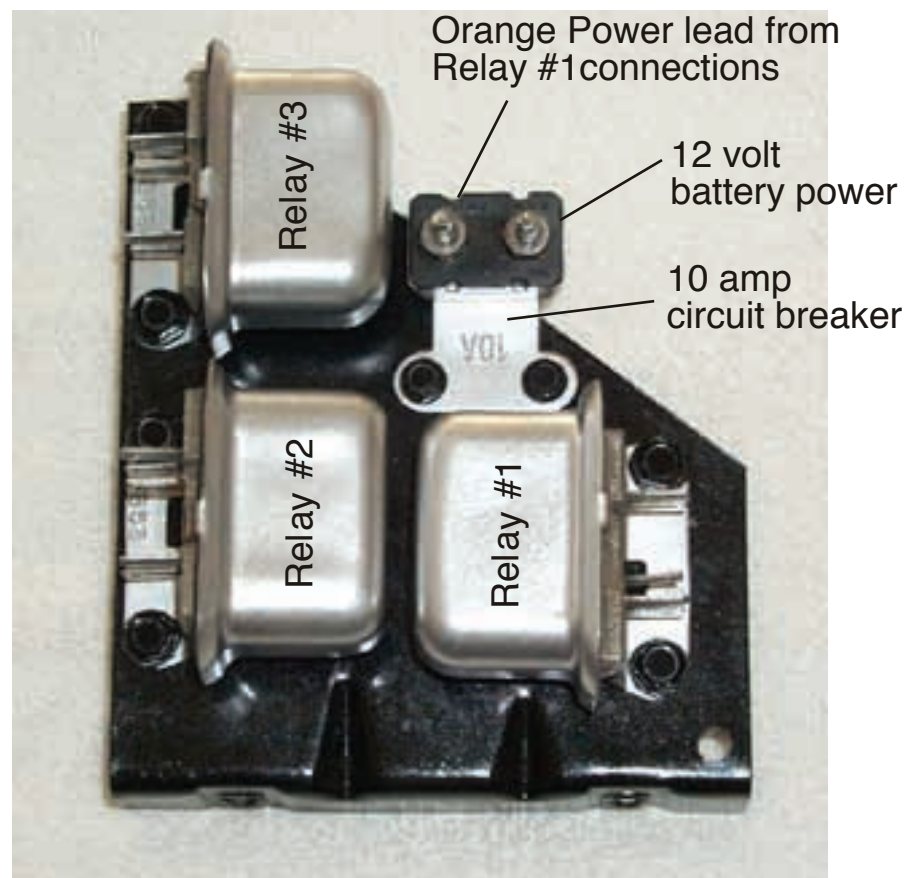
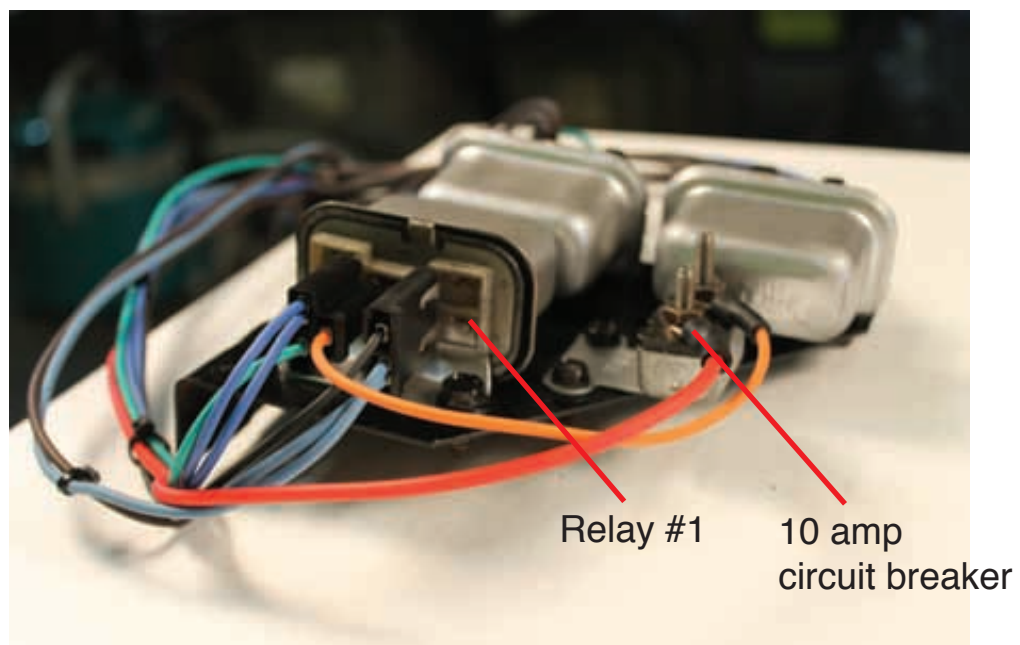

DIAGRAM "B"



## CONNECTION TO RELAY PANEL



Shown above are the connections to Relay #1 and the main circuit breaker. These ring terminals and connectors can be found at **branch 2** on page 1 of this instruction set.

Shown above are the connections to Relays #2 and #3. These connectors can be found at **branch 3** on page 1 of this instruction set.

## RALLY SPORT DIODE HARNESS CONNECTIONS

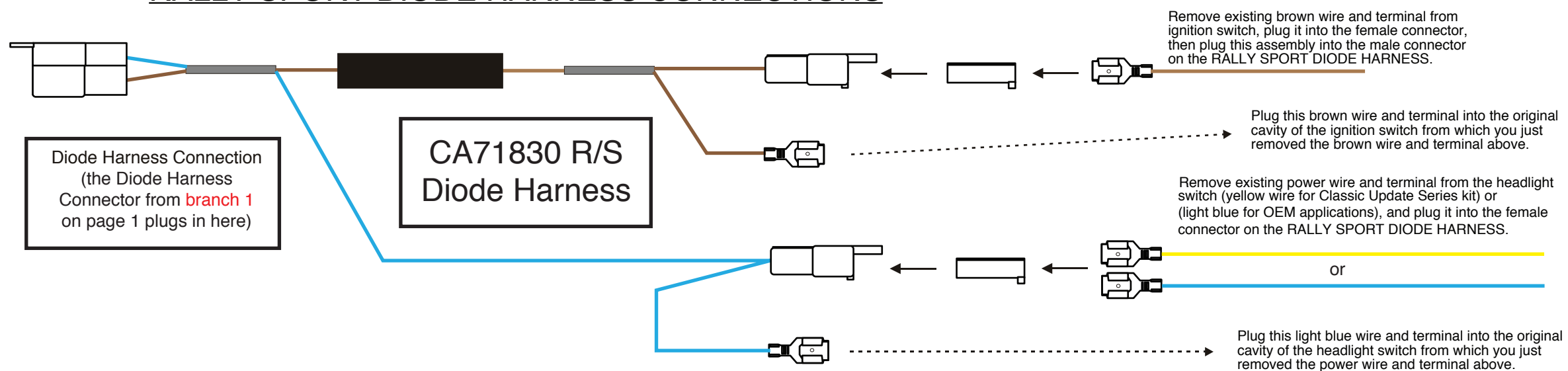

 **American  
Autowire**  
www.americanautowire.com 856-933-0801

Classic Update Series  
1967 Camaro

**Rally Sport Headlight  
Connection Kit**  
**500773**  
92966546 instruction rev 6.0 11/26/2013

# 1967 Camaro RS Headlamp Doors

The material presented here supplements the coverage given in the 1967 Chassis Service Manual on Camaro headlamp doors. The Camaro headlamp door system consists of the following components.

1. The Main Light Switch turns the headlamps on and actuates the door opening motor circuit.
2. The Ignition Switch actuates the door closing circuit. The doors will not close with the ignition switch off.
3. A One-Way Diode in the ignition switch door relay actuating circuit, limits current flow to one direction.
4. A Circuit Breaker to protect the motor circuits is located on a panel under the left front fender.
5. Three Identical Relays to reverse the direction of door motor circuit, as needed for opening or closing, are mounted on a panel under the left front fender.
6. Two Reversible Motors that operate each door. Each motor is equipped with an integral circuit breaker.
7. Limit Switches to turn off the motors as the doors each full travel in either direction. Two switches are mounted at each door location.

The operation of the headlamp doors is as follows:

### In General

The doors open anytime the main light switch is pulled on to the headlamp position. The doors will close only when the ignition switch is in the "ON" or "ACC" position and the main light switch is "OFF".

### Theory or Operation

Two separate electrical circuits are used to operate the headlamp doors. The two circuits are:

1. The headlamp door motor Operating Circuit which consists of:
  - a. Unfused battery power source at a junction block, solenoid, or battery
  - b. A 10-amp circuit breaker
  - c. Three switching relays
  - d. Two limit switches at each door
  - e. A motor at each door
  - f. A harness connecting the above
2. The Control Circuit, used to switch the operating relays, which consists of:
  - a. Main light switch
  - b. Ignition switch
  - c. The energizing coils of the three relays
  - d. The harness between the above
  - e. A one-way diode in the ignition switch side of the harness
  - f. The headlamp filaments to ground

The doors open as follows:

1. The Control Circuit is energized when the headlamps are turned on (through the light blue wire). Relay coil R1 is energized to ground at headlamp ground wire. Relay coils R2 and R3 are not energized because the one-way diode prevents a complete ground path.
2. The motor Operating Circuit is as follows:
  - a. From power source at horn relay junction, to
  - b. Circuit breaker on mounting plate to
  - c. Relay R1 lower contacts (relay energized) to
  - d. Limit switches on radiator support, to
  - e. Door motor, to
  - f. Limit switches on door assemblies, to
  - g. Relay R3 upper contacts (relay not energized), to
  - h. Ground at radiator support
3. The doors move from closed to open and bottom against the limit switches on the radiator support. The limit switch movement breaks the circuit and the door motors stop in the open position.

The doors close as follows:

1. The Control Circuit is energized when the headlamp switch is "OFF" and the ignition switch is "ON". Relay R1 is not energized. Relays R2 and R3 are energized through the ignition switch through the one-way diode, the relay coils, the headlamp switch terminal, the dimmer switch, and finally through the sealed beam filaments to ground.
2. The motor Operating Circuit is as follows:
  - a. Power from source at horn relay junction, to
  - b. Circuit breaker on mounting plate, to
  - c. Relay R1 upper contacts (relay is not energized), to
  - d. Relay R2 lower contacts (relay energized), to
  - e. Limit switches at door assemblies, to
  - f. Door motors, to
  - g. Limit switches at door assemblies, to
  - h. Relay R3 lower contacts (relay energized), to
  - i. Ground at radiator support
3. When doors move to the closed position they bottom against the limit switches on the lamp assemblies. This limit switch movement breaks the circuit and the door motor stops in the closed position.

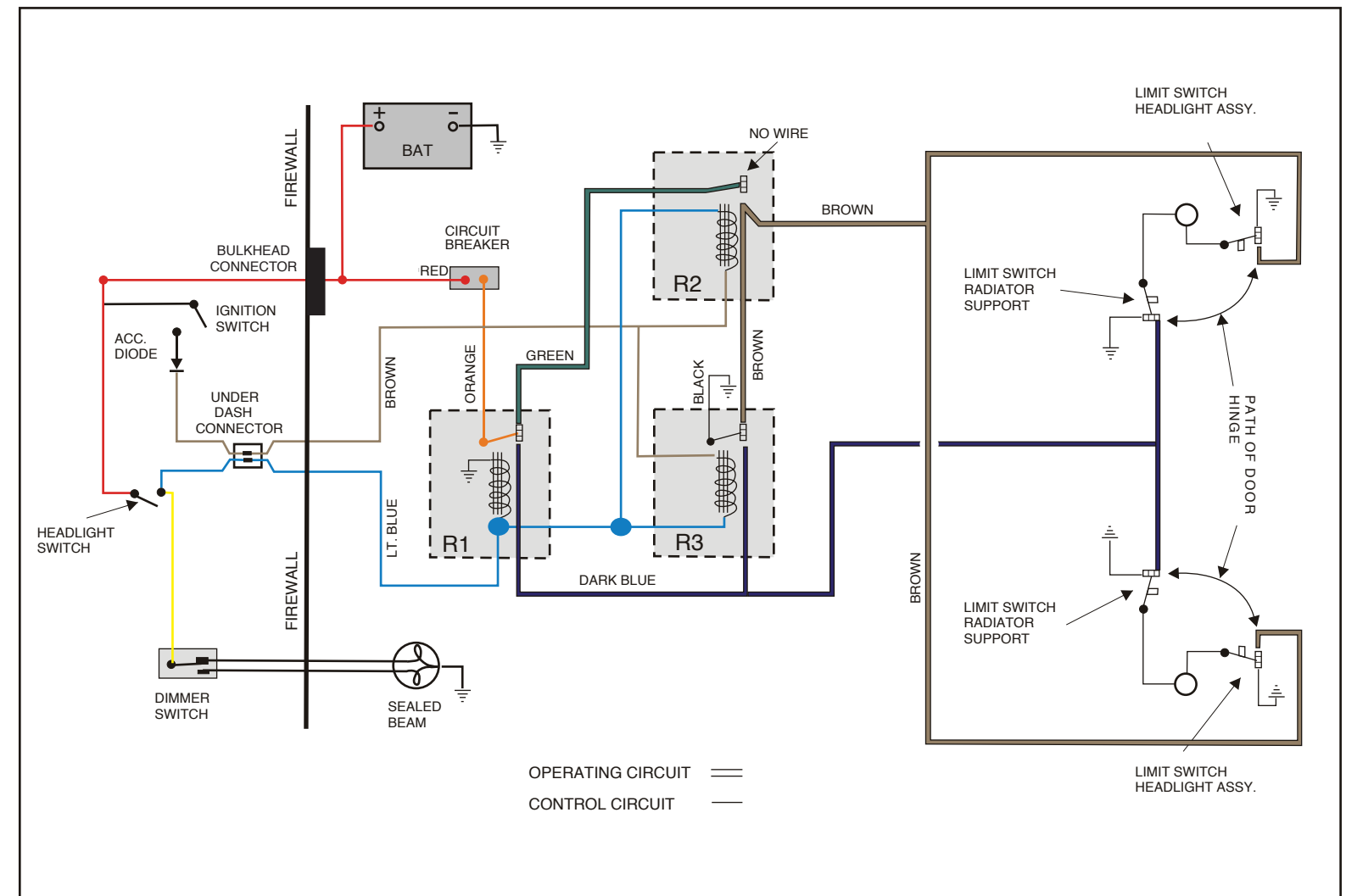

CAMARO HEADLAMP DOOR WIRING - SYSTEM IN "CLOSED" POSITION.



www.americanautowire.com 856-933-0801



## Headlamp Door Diagnosis

### Functional Test

The following three steps should be performed during new car preparation or before any detailed diagnosis is performed.

- I. Start with ignition and headlamp switch both OFF .
- II. Pull headlamp switch to the headlight "ON" position and check to see that:
  - A. Headlamps come on. This circuit is needed to close the doors.
  - B. Headlamp doors open
    1. if they open, one half of the control is ok go to step III.
    2. If they don't open, the add on harness for this option may not be connected at:
      - a. Double connector under dash.
      - b. Main light switch (light blue wire).
    3. If they don't open (and step two is ok) turn the ignition key to ON and observe the doors.
      - a. If they are open, the one way diode is shorted or,
      - b. There may be a short in the brown wire to the ignition switch or,
      - c. The circuit breaker may be defective (possibly caused by a shorted diode or low relay voltage).
- III Start the engine and operate the light switch a number of times to test the lap and door operation. This eliminates a possible marginal voltage condition at the relays if the battery is slightly low. Listen for relay click noise as the headlamp switch is operated from on to off. Also listen for circuit breaker click if the doors fail to function. A circuit breaker click indicates a short in the system.

### Detailed Diagnosis

If the above mentioned steps do not pinpoint the problem, continue diagnosis as follows:

If neither door opens ; look for a defect in area common to both motors.

- A. Check black ground wire from relay R3 to ground at radiator support. This is the motor ground path.
- B. Check to see that Relay R1 is energized by unplugging the two wire connector. The relay should click as connector contact is broken and made. If not, use a test lamp between the two terminals of the two-wire connector. The lamps should light up if the wiring is ok and headlamp switch is "ON". If it does, replace relay R1.
- C. Check to see that relay R3 is not energized by unplugging the two wire connector. The relay should not click when connector contact is broken and made. If the relay does click, there is a possible short in the brown wire to the ignition switch in combination with a broken wire such as might occur in a pinch condition. Check with a test light between ground and each terminal of the two-wire connector. The test light should light both times.
- D. Use a test light and check from ground to the following terminals (test light should light up):

Terminal	Problem if test light does not light
Horn Relay (not used with Classic Update kit)	Open circuit between battery and horn relay
Circuit breaker red wire terminal	Bad red wire or connection to 12v Battery source
Circuit breaker orange wire terminal	Bad circuit breaker
Relay R1 orange wire	Bad orange wire

If neither door closes when lights are turned off, check for voltage at the green wire terminal on Relay R1 (use test lamp to ground). Note: Ignition switch must be "ON" to energize the system and the engine should be running during the check operation.

- A. If there is voltage at green terminal, check for voltage further along the harness towards the motors. If there is no voltage at the brown wire terminal of Relay R2, the R2 and R3 (they are wired in parallel) are not actuated. Check for 12 volts across the two-terminal connectors of both relays (use one test light lead at each terminal of connector).
  1. If voltage is present, replace R2.
  2. If no voltage, check wiring back to the ignition switch making sure that the diode is not open or in backwards.
- B. If voltage is pulsating, due to action of circuit breaker, then R2 has pulled in but R3 has not. Check for 12 volts across the two-terminal connector of R3 (one test light lead at terminal connector). If voltage is present, replace R3. If no voltage, check wiring.
- C. If there is no voltage at green wire terminal of relay R1 (use light test to ground), check for voltage at orange wire terminal or R1.
  1. If voltage is present, replace R1.
  2. If voltage is not present, check for open circuit breaker or wiring.

If one door does not operate the same as the other, look for a malfunction in that particular door s motor, switches or wiring.

### Door does not open

- A. Check for mechanical binding. If motor is being prevented from turning, a flashing blue light in its terminal housing will indicate that the motor s thermal overload switch is operating.
- B. Check for voltage between limit switch (on radiator support) and motor. Use test light from top limit switch terminal ground.
  1. If no voltage is present:
    - a. Check connections at top and bottom of limit switch.
    - b. Check wiring from relay R1 to bottom of limit switch using test light at bottom terminal of light switch. Test light should light.
    - c. Replace limit switch if bad.
  2. If there is voltage present, check for voltage between motor and limit switch on headlamp assembly. If voltage is present:
    - a. Check connections at top and bottom of limit switch.
    - b. Check wiring between bottom of limit switch and ground at relay R3.
    - c. Replace limit switch of headlamp assembly if bad.

### Door does not close

- A. Check for mechanical binding
- B. Check for voltage between limit switch and headlamp assembly and motor:
  1. If no voltage is present:
    - a. Check limit switch connections - top and bottom
    - b. Check wiring from relay R2 to bottom of limit switch. Use test lamp from terminal to ground.
    - c. Replace switch if bad.
  2. If there is voltage present, check for voltage between motor and limit switch at radiator support. If voltage is present:
    - a. Check limit switch connections - top and bottom.
    - b. Check wiring from bottom of limit switch to ground at relay R3.
    - c. Replace limit switch if bad.

### Motor does not stop running at end of door travel.

After a few seconds of stall, the motors thermal overload will start flashing in the terminal housing of the motor. Check for sufficient contact between the door mechanism and the appropriate limit switch for proper switch operation. Push in the switch button to insure operation; if motor continues to flash (operate) replace the switch.

### Door moves jerkily.

- A. Check for loose connection in circuit.
- B. Check for mechanical bind in the door mechanism (the motor s thermal overload will probably be flashing)

## Headlight Door Adjustment

The headlight door adjustment is proper when:

- A. There is clearance all the way around the door in the closed position.
- B. The limit switch is actuated to shut off the door motor.
- C. The door is flush in the opening.

Adjustments can be made as follows:

- A. The door cover is retained by 4 screws threaded into caged nuts. These nuts have up to .090 movement for door cover adjustment when the screws are loosened. Use this adjustment to square the door in the opening by measuring clearance (.025 - .050 ) all the way around.
- B. If the door assembly is cocked at an angle (down or up) in the opening, shim the assembly at its radiator support mounting screws.
- C. Adjustment of the limit switch, if needed, can be obtained by slotting the mounting bracket holes with a round file. This should be used only when the other adjustments fail to provide better than marginal clearance around the door.



www.americanautowire.com 856-933-0801



Classic Update Series  
1967 Camaro

Rally Sport Headlight  
Connection Kit  
500773

92966546 instruction rev 6.0 11/26/2013

THIS PAGE HAS BEEN  
INTENTIONALLY LEFT BLANK

