

INSTALLING THE FUSE BOX

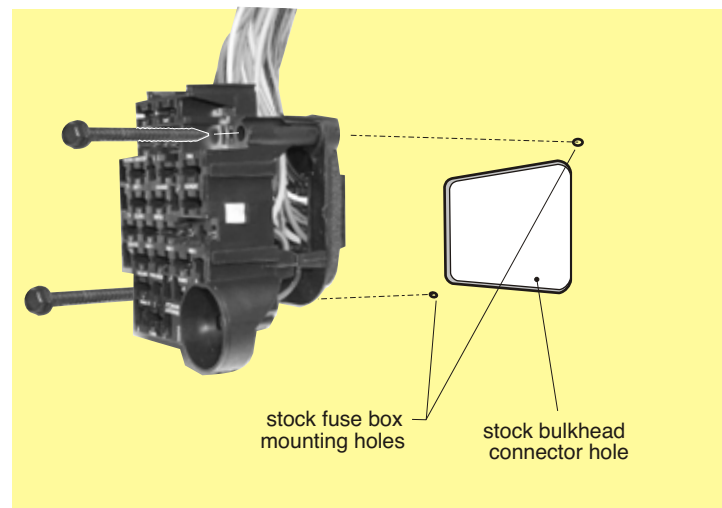

1. Locate the stock OEM bulkhead hole in the driver side of the firewall.
2. Mount the fuse box with the flasher can in the bottom right corner, as shown above.
3. Using the two mounting screws A, attached the fuse panel to the firewall.

Fuse Panel Installation Instructions

Following these simple instructions will guarantee a successful installation of your American Autowire fuse panel harness.

1. Study the diagram above to familiarize yourself with the dash harness.
2. Install the fuse box.
3. Route the dash harness using the factory support straps.
4. Make all connections as shown on the following pages of this dash harness kit.
5. Once this harness is installed, continue to bag 'H', and install the rest of the kit (bags H,J,K,L,M).



**American
Autowire**

American Autowire / Factory-Fit
800-482-9473



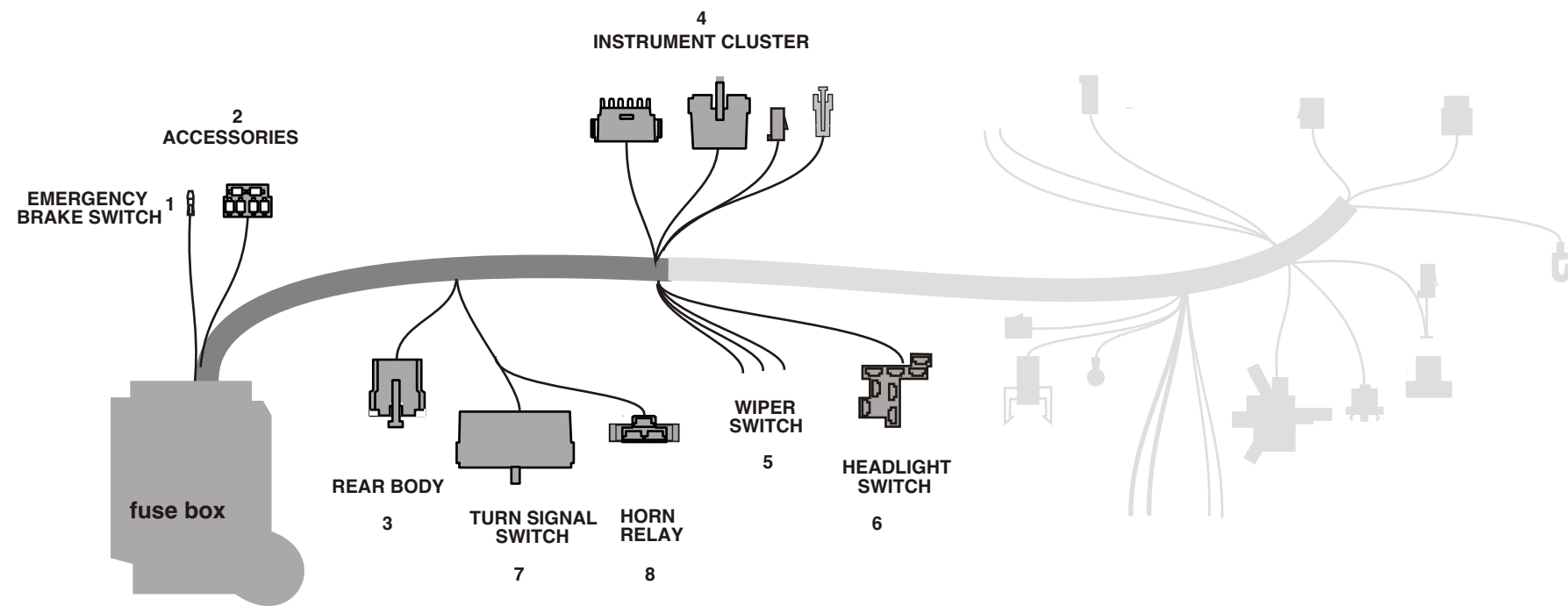

1	EMERGENCY BRAKE	Tan	Connect to the emergency brake switch. This is the ground circuit for the brake switch light.																					
2	ACCESSORIES		Use the provided connector J attached and terminals as power leads for the following: <table border="1"> <thead> <tr> <th>Fuse</th> <th>Rating</th> <th>Description</th> </tr> </thead> <tbody> <tr> <td>Dark Blue</td> <td>FUEL 15 amp</td> <td>Fused 12 volt IGNITION feed for fuel pump (may also be used to feed power to another ignition circuit)</td> </tr> <tr> <td>Orange</td> <td>BAT1 20 amp</td> <td>Fused 12 volt BATTERY feed for power seats (may also be used to feed power to another battery circuit)</td> </tr> <tr> <td>Red</td> <td>BAT2 30 amp</td> <td>Fused 12 volt BATTERY feed for power door locks (may also be used to feed power to another accessory circuit)</td> </tr> <tr> <td>Pink</td> <td>IGN1 20 amp</td> <td>Fused 12 volt IGNITION feed for cruise control (may also be used to feed power to another ignition circuit)</td> </tr> <tr> <td>Yellow</td> <td>PWRWDO 30 amp</td> <td>Fused 12 volt IGNITION feed for power windows (may also be used to feed power to another ignition circuit)</td> </tr> <tr> <td>Tan</td> <td>ACCY1 30 amp</td> <td>Fused 12 volt ACCESSORY feed (may also be used to feed power to an accessory circuit)</td> </tr> </tbody> </table>	Fuse	Rating	Description	Dark Blue	FUEL 15 amp	Fused 12 volt IGNITION feed for fuel pump (may also be used to feed power to another ignition circuit)	Orange	BAT1 20 amp	Fused 12 volt BATTERY feed for power seats (may also be used to feed power to another battery circuit)	Red	BAT2 30 amp	Fused 12 volt BATTERY feed for power door locks (may also be used to feed power to another accessory circuit)	Pink	IGN1 20 amp	Fused 12 volt IGNITION feed for cruise control (may also be used to feed power to another ignition circuit)	Yellow	PWRWDO 30 amp	Fused 12 volt IGNITION feed for power windows (may also be used to feed power to another ignition circuit)	Tan	ACCY1 30 amp	Fused 12 volt ACCESSORY feed (may also be used to feed power to an accessory circuit)
Fuse	Rating	Description																						
Dark Blue	FUEL 15 amp	Fused 12 volt IGNITION feed for fuel pump (may also be used to feed power to another ignition circuit)																						
Orange	BAT1 20 amp	Fused 12 volt BATTERY feed for power seats (may also be used to feed power to another battery circuit)																						
Red	BAT2 30 amp	Fused 12 volt BATTERY feed for power door locks (may also be used to feed power to another accessory circuit)																						
Pink	IGN1 20 amp	Fused 12 volt IGNITION feed for cruise control (may also be used to feed power to another ignition circuit)																						
Yellow	PWRWDO 30 amp	Fused 12 volt IGNITION feed for power windows (may also be used to feed power to another ignition circuit)																						
Tan	ACCY1 30 amp	Fused 12 volt ACCESSORY feed (may also be used to feed power to an accessory circuit)																						
3	REAR BODY		This connector will mate to the connector from the Rear Body harness found in bag L. <table border="1"> <tbody> <tr><td>Tan</td><td>Fuel tank sender lead</td></tr> <tr><td>Brown</td><td>Tail lamp feed</td></tr> <tr><td>Yellow</td><td>LH turn / brake feed</td></tr> <tr><td>Dark Green</td><td>RH turn / brake feed</td></tr> <tr><td>Orange</td><td>Dome / courtesy lamp feed</td></tr> <tr><td>White</td><td>Dome / courtesy lamp ground</td></tr> <tr><td>Light Green</td><td>Back up lamp feed</td></tr> <tr><td>Light Blue</td><td>Third brake light</td></tr> </tbody> </table>	Tan	Fuel tank sender lead	Brown	Tail lamp feed	Yellow	LH turn / brake feed	Dark Green	RH turn / brake feed	Orange	Dome / courtesy lamp feed	White	Dome / courtesy lamp ground	Light Green	Back up lamp feed	Light Blue	Third brake light					
Tan	Fuel tank sender lead																							
Brown	Tail lamp feed																							
Yellow	LH turn / brake feed																							
Dark Green	RH turn / brake feed																							
Orange	Dome / courtesy lamp feed																							
White	Dome / courtesy lamp ground																							
Light Green	Back up lamp feed																							
Light Blue	Third brake light																							
4	INSTRUMENT CLUSTER DISCONNECTS		These connectors will plug into the gauge disconnect harness from bag H. Wire identifications are described on the instruction sheets from bag H.																					
5	WIPER	Black Dk Blue Lt Blue	Black: Ground circuit for low speed. Dk Blue: Ground circuit for washer. Lt Blue: Ground circuit for hi speed.																					
6	HEADLIGHT SWITCH	Red Orange Brown Yellow Dk Green White	Red: 12 volt feed to switch Orange: 12 volt feed in to park/tail Brown: Park lamp feed out Yellow: Dimmer feed Dk Green: Instrument lamp feed White: Dome / courtesy ground BAT location on headlight switch PARK / TAIL FEED IN location on headlight switch. (commonly found on GM headlight switches) PARK LAMP OUT location on headlight switch. DIMMER FEED location on headlight switch. INSTRUMENT LAMP location on headlight switch. GROUND location on headlight switch.																					
7	TURN SIGNAL SWITCH	White Dark Green Yellow Purple Brown Dark Blue Light Blue Black	This harness has a connector on it for the 3-7/8 1969-1974 GM column connection used by GM and many after-market manufacturer s. If you are using a stock 1964-67 turn signal switch, remove the existing connector and terminals from your steering column and install terminals M and connector L (see diagram G) on page 3. If using a late model GM steering column or an after-market column using the 4-1/4 GM turn signal connector, replace existing connector with connector L, matching wires by color. White: 12 volt feed from brake switch Dark Green: RH tail lamp Yellow: LH tail lamp Purple: 12 volt feed from turn flasher Brown: 12 volt feed from hazard flasher Dark Blue: RH front park lamp Light Blue: LH front park lamp Black: Horn relay ground wire to horn switch																					
8	HORN RELAY	Red Black Green	Plug the horn relay (found in the fuse bag) into this connector. Red: 12 volt battery Black: Relay ground circuit (to steering column) Green: Triggered 12 volts to horn																					

Wiper switch connections

In each case install the female terminal supplied and apply connector shown.

64, 65 Single Speed with washer

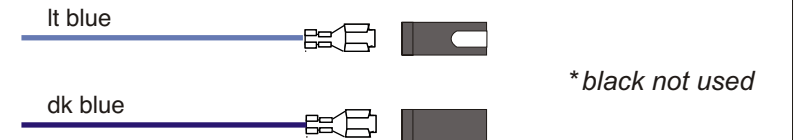

64, 65 2 Speed with washer

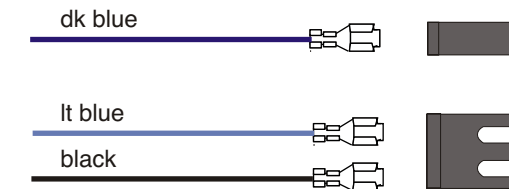

66 2 Speed with washer

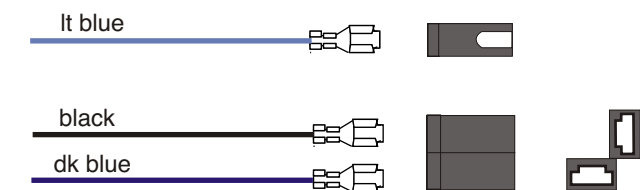

67 Chevelle All

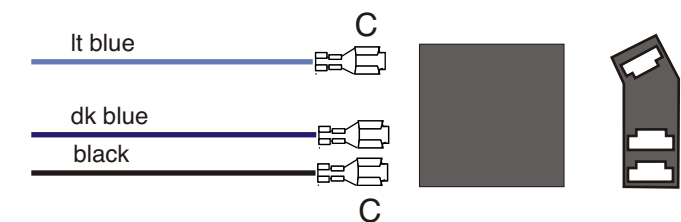

American Autowire / Factory-Fit
800-482-9473

1964-67 Chevelle
DASH KIT
500957

92968111 instruction rev 0.0 6/13/2007

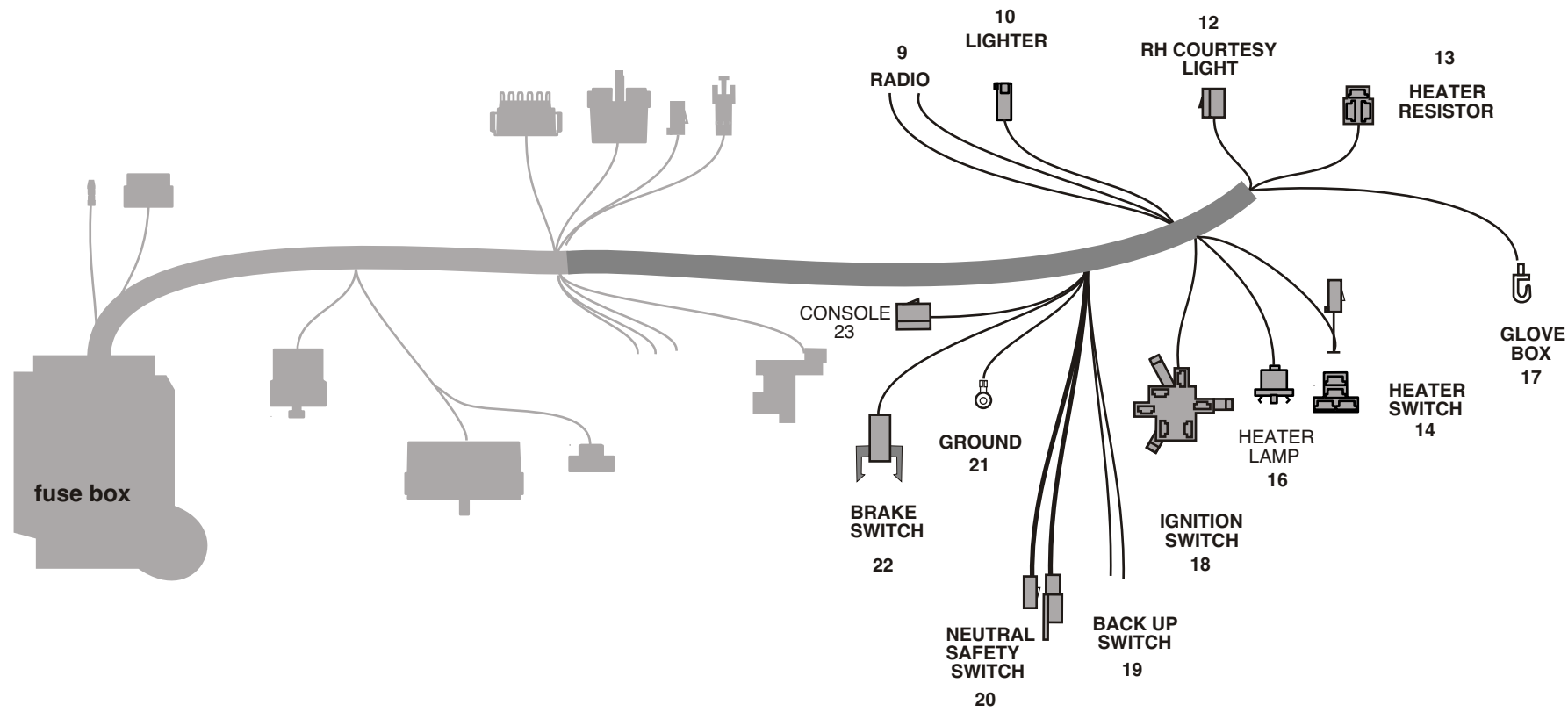

9	RADIO	Tan	Radio accessory feed.
		Yellow	Radio 12 volt clock lead (battery feed)
10	LIGHTER	Orange	Connect to lighter. (battery feed)
11	CONSOLE CONNECTION	These wires are for use on a console vehicle. For wire functions, refer to bag K, 500664.	
12	RH COURTESY LAMP	Plug this connector into the mating connector from the courtesy lamp kit bag N, 500708.	
		Orange	12 volt battery feed to lamp
		White	Ground circuit for lamp
13	HEATER RESISTOR	Plug this connector into the factory heater resistor located on top of the heater box of a non A/C car.	
14	HEATER SWITCH	Plug this connector into the factory heater switch.	
		Brown	12 volt accessory feed to heater / ac switch (if using aftermarket a/c, use the short brown wire as the accessory feed wire to a/c harness.)
		Yellow	Heater resistor
		Lt Blue	Heater resistor
		Orange	Heater resistor
16	HEATER LAMP	Gray	Heater lamp
17	GLOVE BOX LIGHT	Orange	Connect to the original factory glove box lamp switch. If not using, just unplug and tape back.
18	IGNITION SWITCH	Red	12 volt battery feed
		Pink	12 volt ignition feed
		Brown	12 volt accessory feed
		Purple	12 volt starter feed
19	BACK UP SWITCH	Connect these wires to the back up switch on the column or console shifter.	
		Pink	12 volt ignition feed 'in' to back up lamp switch
		Lt Green	12 volt feed 'out' to back up lamps
20	NEUTRAL SAFETY SWITCH	Connect these wires to the neutral safety switch on the column, console shifter, or plug together if using a manual transmission.	
		Purple	12 volt feed 'in' to neutral safety switch.
		Purple	12 volt feed 'out' to starter
21	GROUND	Black	Connect to a good chassis ground.
22	BRAKE SWITCH	Plug this connector into the factory brake switch.	
		Orange	12 volt feed 'in' to switch.
		White	12 volt feed 'out' to steering column switch.
		Lt Blue	12 volt feed 'out' to third brake light.
23	CONSOLE	Plug into console extension 500988 where applicable.	
		Orange	12 volt battery feed
		Grey	Console illumination lamp
		White	Courtesy ground

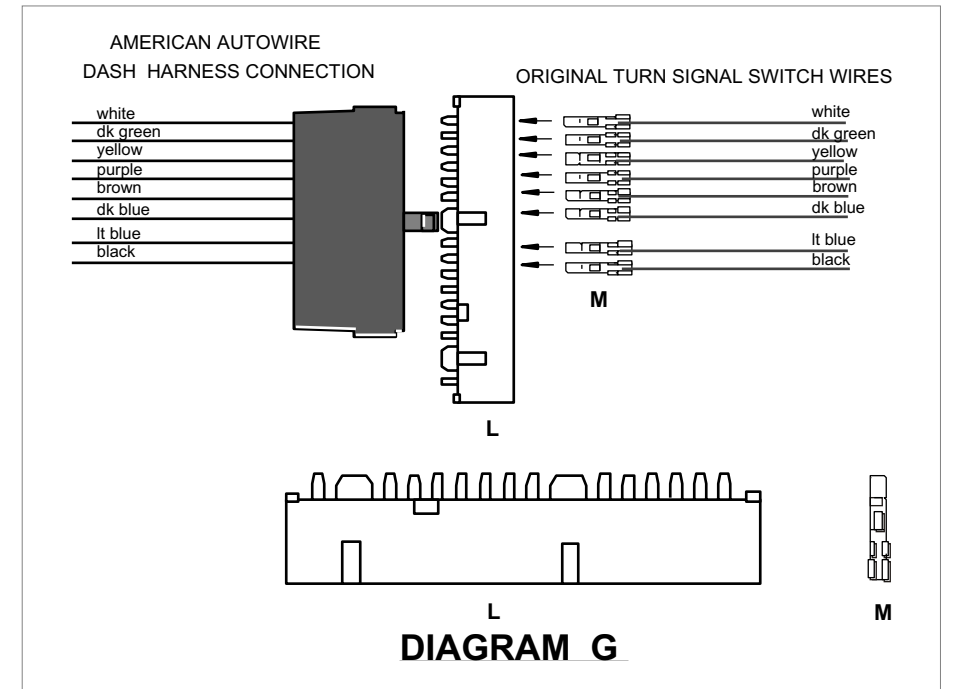

American Autowire / Factory-Fit
800-482-9473

1964-67 Chevelle
DASH KIT
500957

92968111 instruction rev 0.0 6/13/2007