

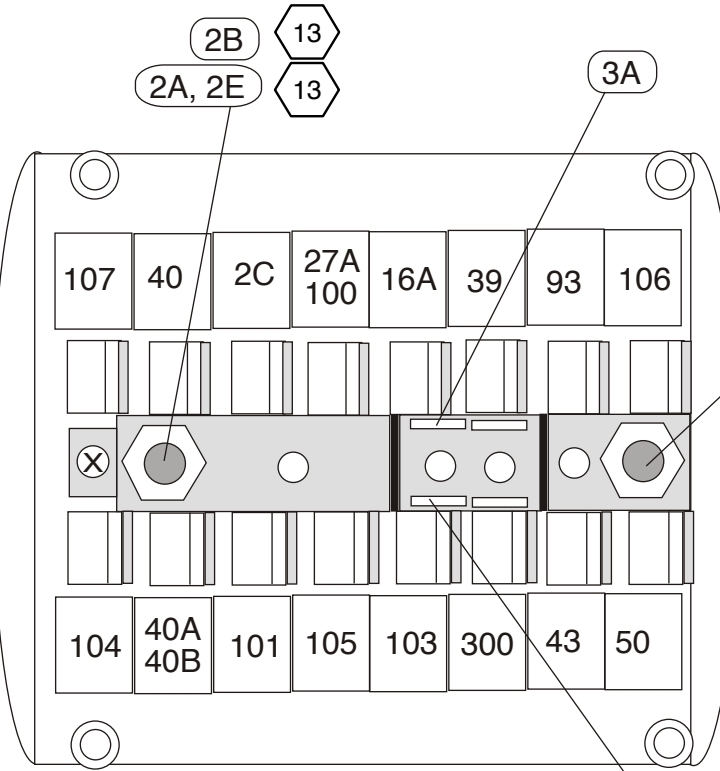

150 Heller Pl #17 W Bellmawr, NJ 08031 856-933-0801

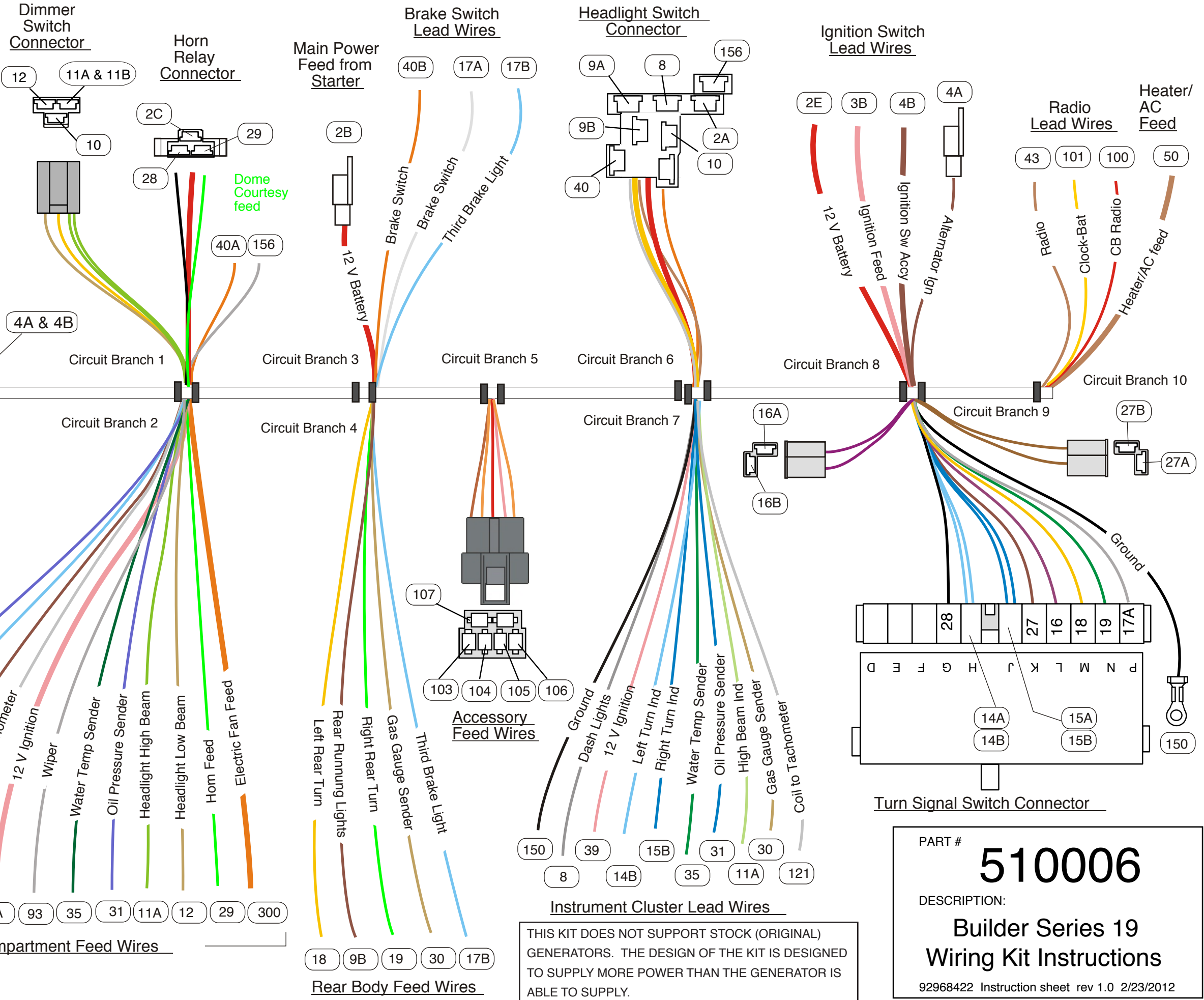

Fuse Box Connections (viewed from underside)



THIS KIT DOES NOT SUPPORT STOCK (ORIGINAL) GENERATORS. THE DESIGN OF THE KIT IS DESIGNED TO SUPPLY MORE POWER THAN THE GENERATOR IS ABLE TO SUPPLY.

PART #
510006
 DESCRIPTION:
Builder Series 19
Wiring Kit Instructions
 92968422 Instruction sheet rev 1.0 2/23/2012

Main Fuse Panel

The Main Fuse Panel harness is designed to be mounted under the dash at the firewall in an area close to the steering column.

The enclosed representation of the main dash harness shows each circuit branch and identifies each connection by its color and function. Follow the drawing for the individual circuit connections.

Circuit Branch 1 - Horn and Dimmer Switch connections

1. Insure that the Horn relay is plugged into the connector. No further action is required.
2. Insure that the Dimmer switch is plugged into the connector.
3. The orange Dome Courtesy Feed wire (40A) routes to the courtesy light power feed. Most courtesy lights are activated by the headlight switch or individual door jamb switches setting a ground connection.
4. The white Courtesy Ground wire (156) routes to the courtesy light ground. This wire enables the headlight switch to turn on the courtesy lights.

Circuit Branch 2- Front end connections

1. Select the dark blue Right Front Turn wire (15A) and connect it to the right front directional lamp socket. If you are using a single front directional light with an 1157 or dual filament bulb, this wire would be connected to the high filament of the bulb.
2. Select the light blue Left Front Turn wire (14A) and connect it to the left front directional lamp socket. If you are using a single front directional light with an 1157 or dual filament bulb, this wire would be connected to the high filament of the bulb.
3. Select the brown Park Lights wire (9A) and connect it to both the front park / running light sockets. If you are using a single front directional light with an 1157 or dual filament bulb, this wire would be connected to the low filament of each of the front running lights. An in-line splice of this wire will be necessary to accommodate wiring of both of the front park / running lights.
4. Select the white Coil to Tachometer wire (121). This can be connected directly to the tach terminal on a GM HEI distributor, to the Negative side of the coil, or a tach connection in an aftermarket ignition module such as an MSD module. See the installation instructions for the type of distributor you are using for specific connection requirements.
5. Select the pink 12V Ignition wire (39). This is the 12 volt power source for the distributor. This can be connected directly to the distributor, as in a GM HEI distributor, to a ballast resistor as in a points type distributor, or to the ignition power source for an aftermarket ignition module such as an MSD module. See the installation instructions for the type of distributor you are using for specific connection requirements.
6. Select the white Wiper feed wire (93). Route and connect it to the wiper motor power connection.
7. Select the dark blue Oil Pressure Sender wire (31). Route and connect it to the electric oil pressure sender.
8. Select the dark green Water Temp Sender wire (35). Route and connect it to the water temperature sender.
9. Select the light green Headlight High Beam wire (11A) and tan Headlight Low Beam wire (12). Route and connect these wires to the headlights. An in-line splice of this wire will be necessary to accommodate wiring of both of the headlights. Using the supplied terminals and connectors, connect these wires along with the headlight ground wires to the headlight connectors according to the orientation in the diagram on this page.
10. Select the dark green Horn feed wire (29). Route and connect it to the horn power terminal. If your horn has a separate ground terminal, you must supply this ground wire as it is not included in the kit.
11. Select the orange Electric Fan Feed wire (300). It is recommended that this wire be routed and connected to a fan relay. This wire is the relay trigger connection and should be connected to terminal (85 or 86) of the relay. Optional fan relay kits 500479, 500142, 500339, 500511, 500784, 500846, 510001, and 510002 are available from American Autowire to accommodate fan amperage requirements.

Fuse Box Connections (viewed from top side)

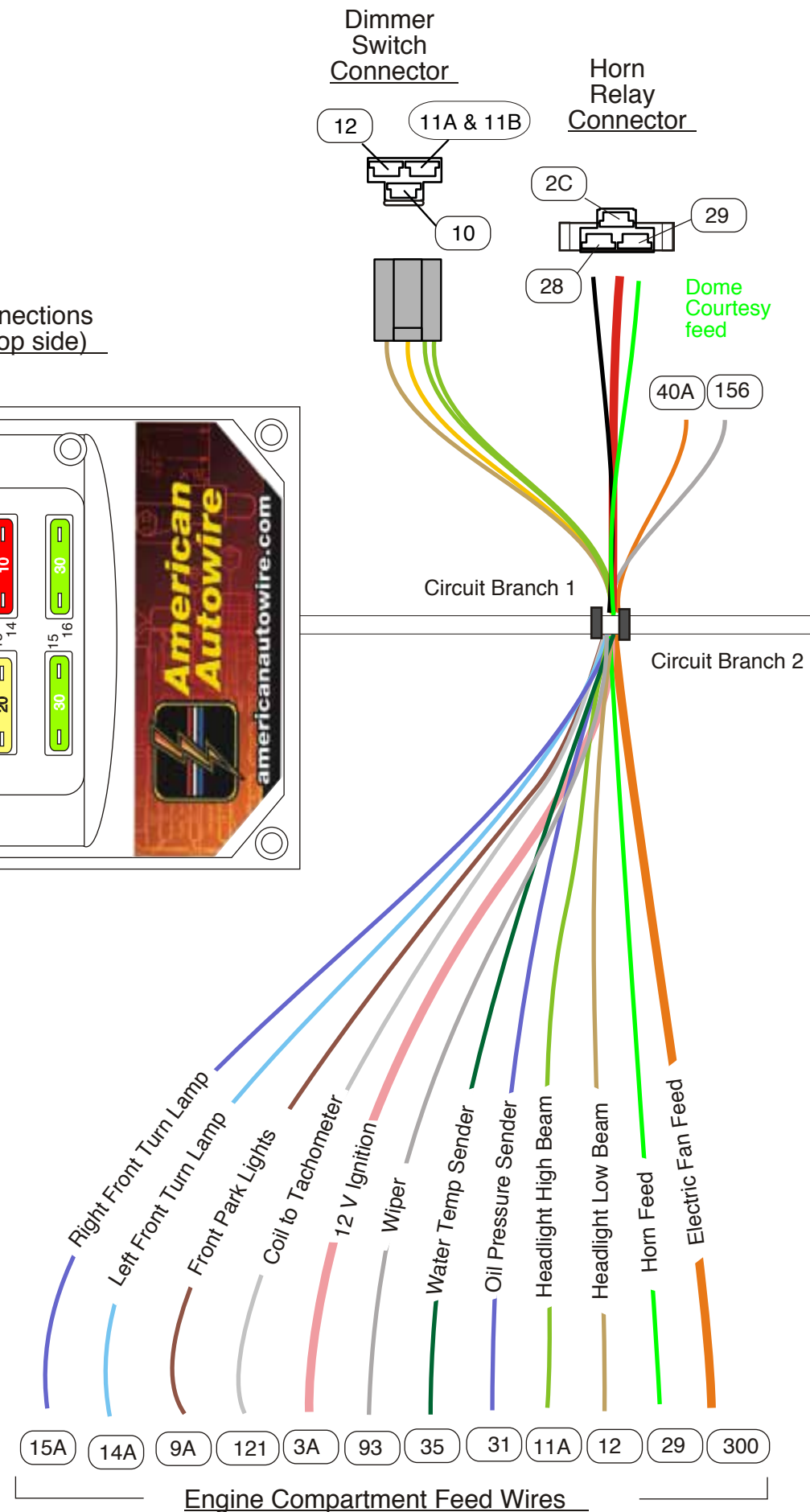
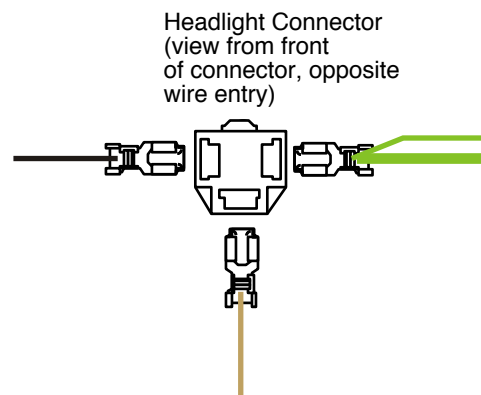
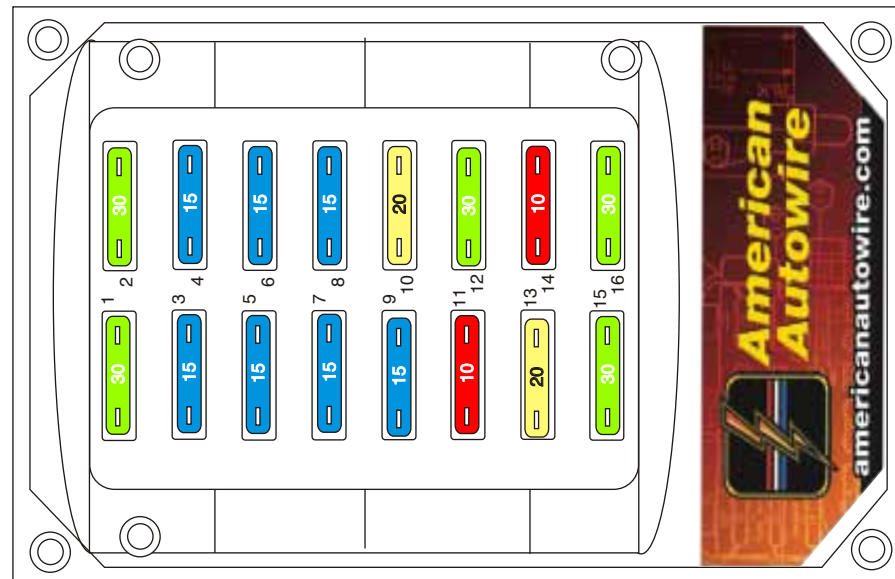

PART #
510006
 DESCRIPTION:
Builder Series 19
Wiring Kit Instructions
 92968422 Instruction sheet rev 1.0 2/23/2012

Circuit Branch 3 - Main Power and Brake Switch Connections

1. Select the orange Brake Switch wire (40B) and connect it to the input side of the brake switch.
2. Select the white Brake Switch wire (17A) and connect it to the output side of the brake switch.
3. Select the light blue Third Brake Light wire (17B). If you are using a third brake light, route this wire together with the white Brake Switch wire (17A) and connect them both to the output side of the brake switch. If you are not using a third brake light, the light blue Third Brake Light wire (17B) should be taped back against the harness and left unconnected or removed from the main harness.
4. The main power input wire from sub kit 510011 is plugged into this connector. Connection descriptions are described on page 6.

Circuit Branch 4 - Rear Body Connections

Route the rear body wires to the rear of the car and connect as follows:

1. Select the yellow Left Rear Turn wire (18) and connect it to the left rear directional lamp socket. If you are using a single tail light with an 1157 or dual filament bulb, this wire would be connected to the high filament of the bulb.
2. Select the dark green Right Rear Turn wire (19) and connect it to the right rear directional lamp socket. If you are using a single tail light with an 1157 or dual filament bulb, this wire would be connected to the high filament of the bulb.
3. Select the Rear Running Lights wire (9B) and connect it to the rear running lamp socket. If you are using a single tail light with an 1157 or dual filament bulb, this wire would be connected to the low filament of each of the rear running lights. An in-line splice of this wire will be necessary to accommodate wiring of both of the rear running lights.
4. Select the light blue Third Brake Light wire (17B). If you are using a third brake light, route this wire to the third brake light brake switch. If you are not using a third brake light, this wire should be taped back against the harness and left unconnected.
5. Select the tan Gas Gauge Sender wire (17B). If you are using a third brake light, route this wire to the third brake light. If you are not using a third brake light, this wire should be taped back against the harness and left unconnected.

Circuit Branch 5 - Accessory Feed Wire Connections

This kit provides 5 additional fused power circuits that can be connected through the included terminals and disconnect as follows:

wire #	Type	color	Printing	Function
103	Ignition	Tan	Fuel Pump	Fuel pump power.
104	Battery	Orange	Power Seats	Power seats power.
105	Battery	Red	Power Locks	Power door locks power.
106	Accessory	Pink	Power windows	Power windows power.
107	Battery	Orange	12 volt battery fused	Spare 12 volt battery fused power.

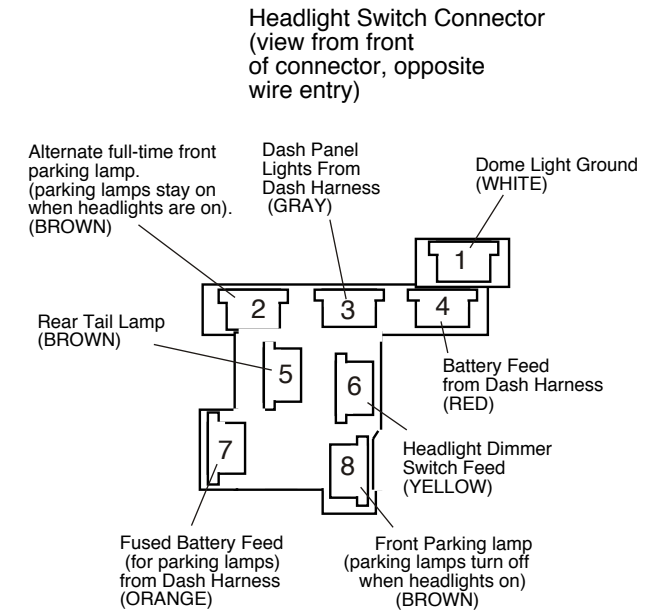
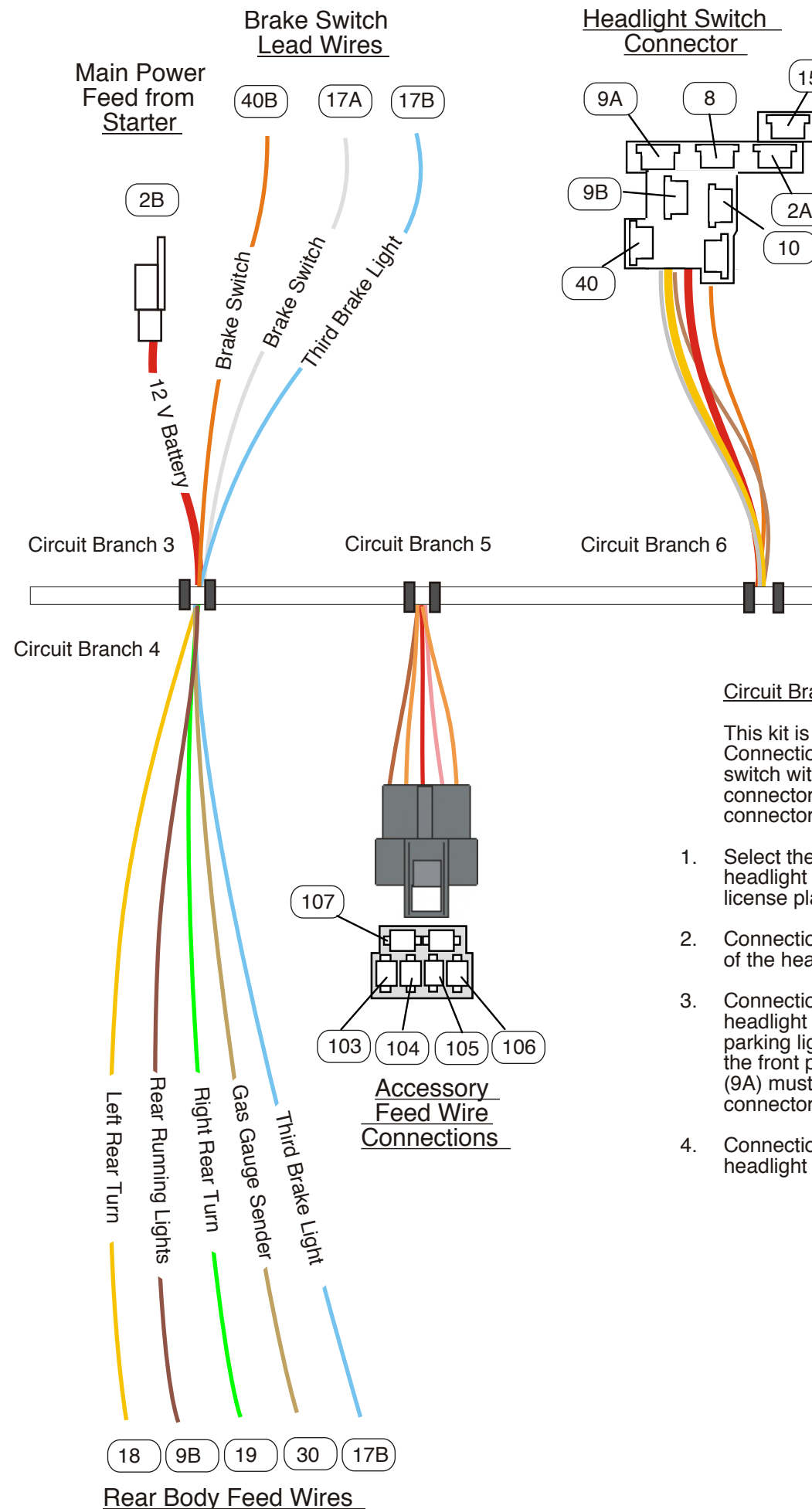

Circuit Branch 6 - Headlight Switch Connection Kit

This kit is designed to function with a GM style headlight switch. Connections are functionally the same with any other type of headlight switch with the exceptions noted below. Orient the headlight switch connector as shown in the diagram. You will be looking at the front of the connector opposite the wire entry end.

1. Select the brown Rear Running Lights wire (9B) from location 5 of the headlight switch connector. This wire is for the rear running lights and license plate lights.
2. Connections for the white Courtesy Light Ground wire (156) from location 1 of the headlight switch connector are described on page 2.
3. Connections for the brown Park Lights wire (9A) from location 2 of the headlight switch connector are described on page 2. In this setup the front parking lights will remain on when the headlights are turned on. If you want the front parking lights to go off when the headlights are turned on, this wire (9A) must be moved from location 2 to location 8 in the headlight switch connector.
4. Connections for the gray Dash Lights wire (8) from location 3 of the headlight switch connector are described on page 4.

PART #
510006
 DESCRIPTION:
Builder Series 19
Wiring Kit Instructions
 92968422 Instruction sheet rev 1.0 2/23/2012

TYPICAL BLADE TYPE GAUGE CONNECTIONS

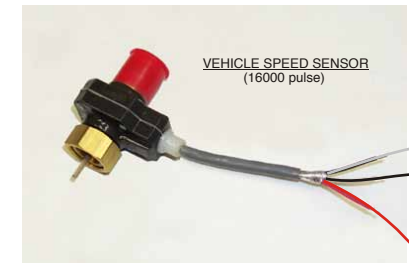
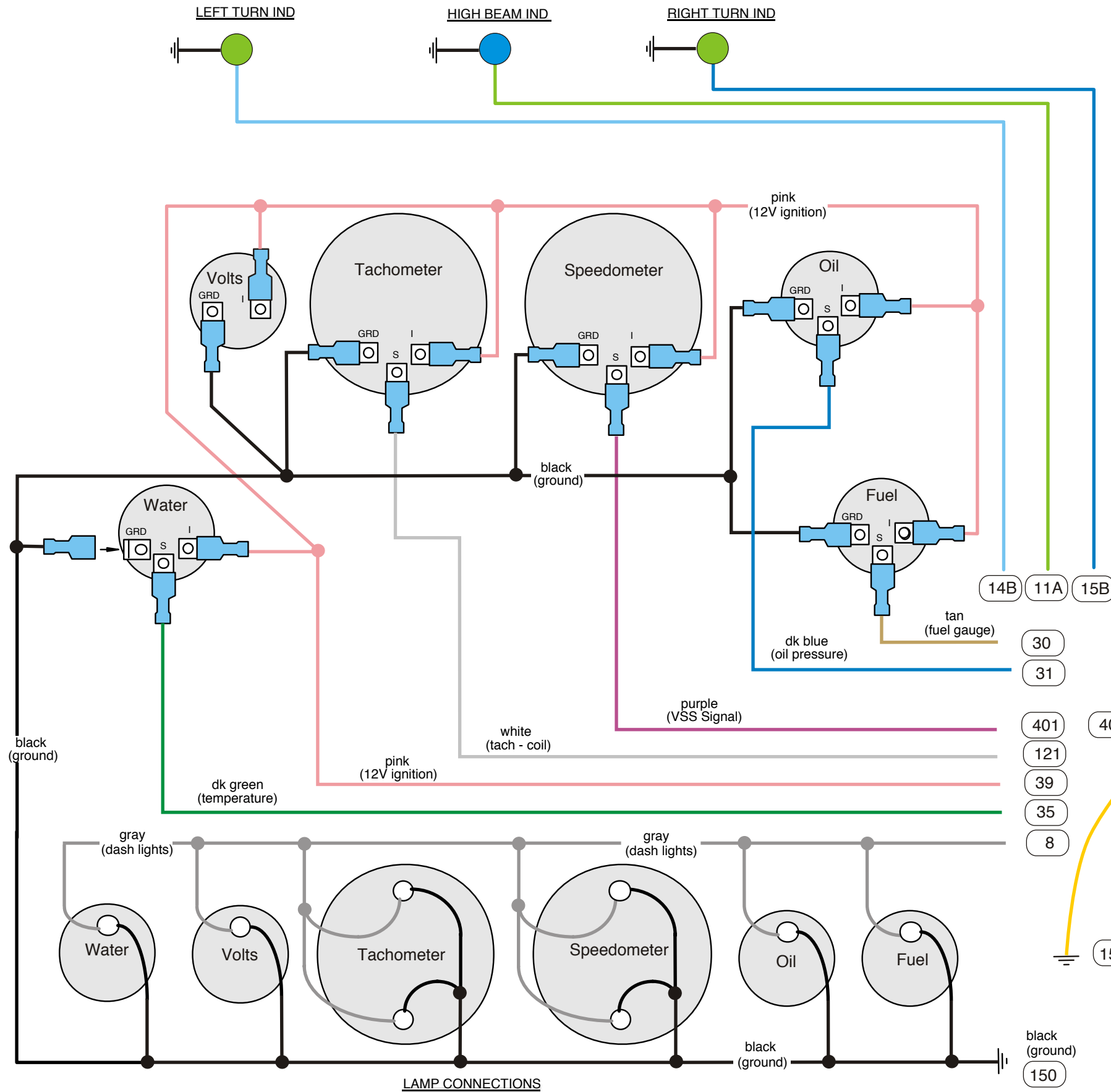

Typical 3 wire Autometer 5291 VSS connection

Note: This VSS requires a lead wire from the red wire to a 12 volt ignition source. This wire is not included in the kit.

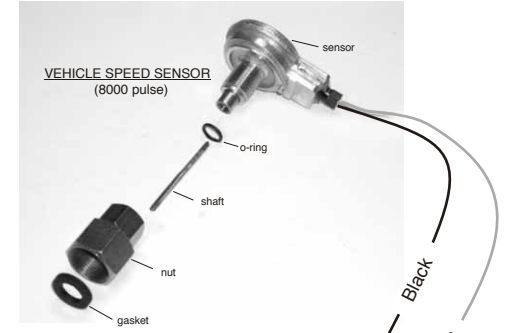

Typical 2 wire VSS connection

connect to 12 volt ignition source

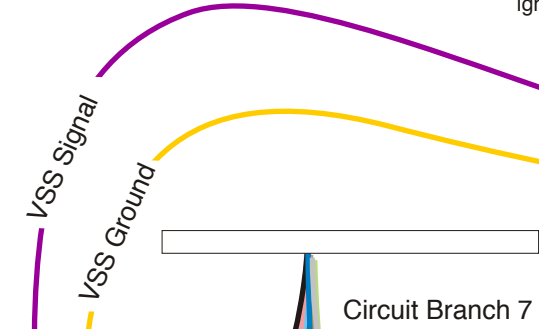

Circuit Branch 7 - Instrument Cluster Wiring

Shown is a typical installation with electric gauges and an electronic speedometer and tachometer. Mechanical speedometers with only require the light leads. The VSS lead wires are supplied separately in sub-kit 510011 and can be ignored for mechanical speedometers. Always check the manufacturers instructions for specific installation requirements.

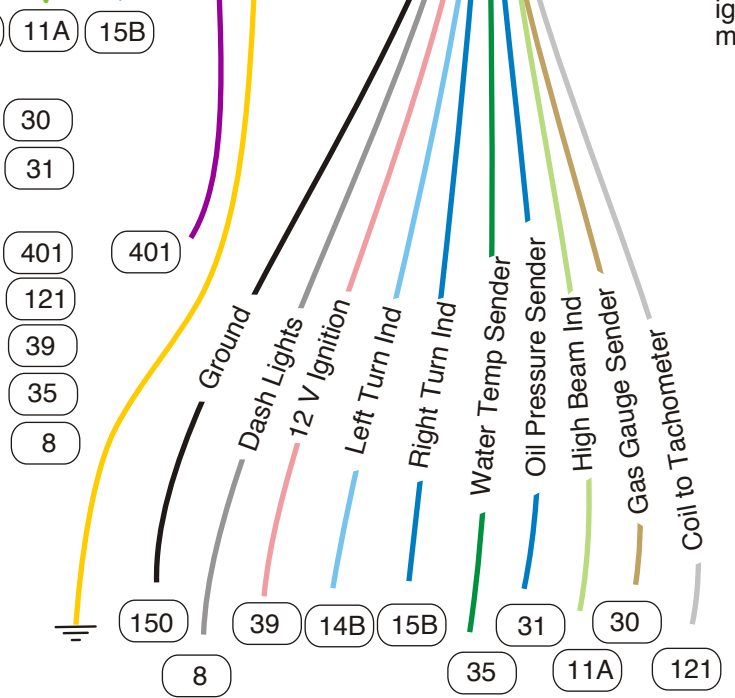

PART #
510006
 DESCRIPTION:
Builder Series 19
Wiring Kit Instructions
 92968422 Instruction sheet rev 1.0 2/23/2012

Circuit Branch 8 - Ignition Switch Connections

Connect these lead wires as follows:

1. Select the red 12 V Battery wire (2E) and connect it to the battery terminal on the ignition switch.
2. Select the pink Ignition Feed wire (3B) and connect it to the ignition terminal on the ignition switch.
3. Select the heavy brown Ignition SW Accessory wire (4B) and connect it to the accessory terminal on the ignition switch.

Alternator and Starter Wiring

The following wires can be found in the 510011 - Alternator, Starter, Headlight ground sub kit

1. Select the red 12 V Battery main power wire with the brown fusible link. Route this wire to the dash at branch 3 from the starter solenoid. Cut to length, apply the appropriate terminal and connector, and plug into the dash harness main power connector wire (2D).
2. Select the red 12 V Battery alternator power wire with the blue fusible link. Route this wire to the alternator from the starter solenoid. Cut to length, apply the protection boot and the appropriate ring terminal, and bolt the power wire to the alternator power stud.
3. Select the brown Alternator Ign alternator exciter wire. Route this wire to the dash harness. Cut to length, apply the appropriate terminal and connector, and plug into the dash harness brown Alternator Ign exciter connection wire (4A) on the main dash harness. If you are using a one wire alternator, this exciter wire, and the 2 way alternator connector, will not be used. Subsequently, the only connection at the alternator will be the power connection to the alternator power stud.
4. Select the purple Starter Solenoid wire. Route this wire from the neutral safety switch to the "S" terminal on the starter solenoid.
5. Select the purple Neutral Safety Switch wire. Route this wire from the neutral safety switch to the "SOL" terminal on the ignition switch. If you are not using a neutral safety switch, these wires can be connected together to create a direct connection from the ignition switch "SOL" terminal to the starter solenoid "S" terminal.

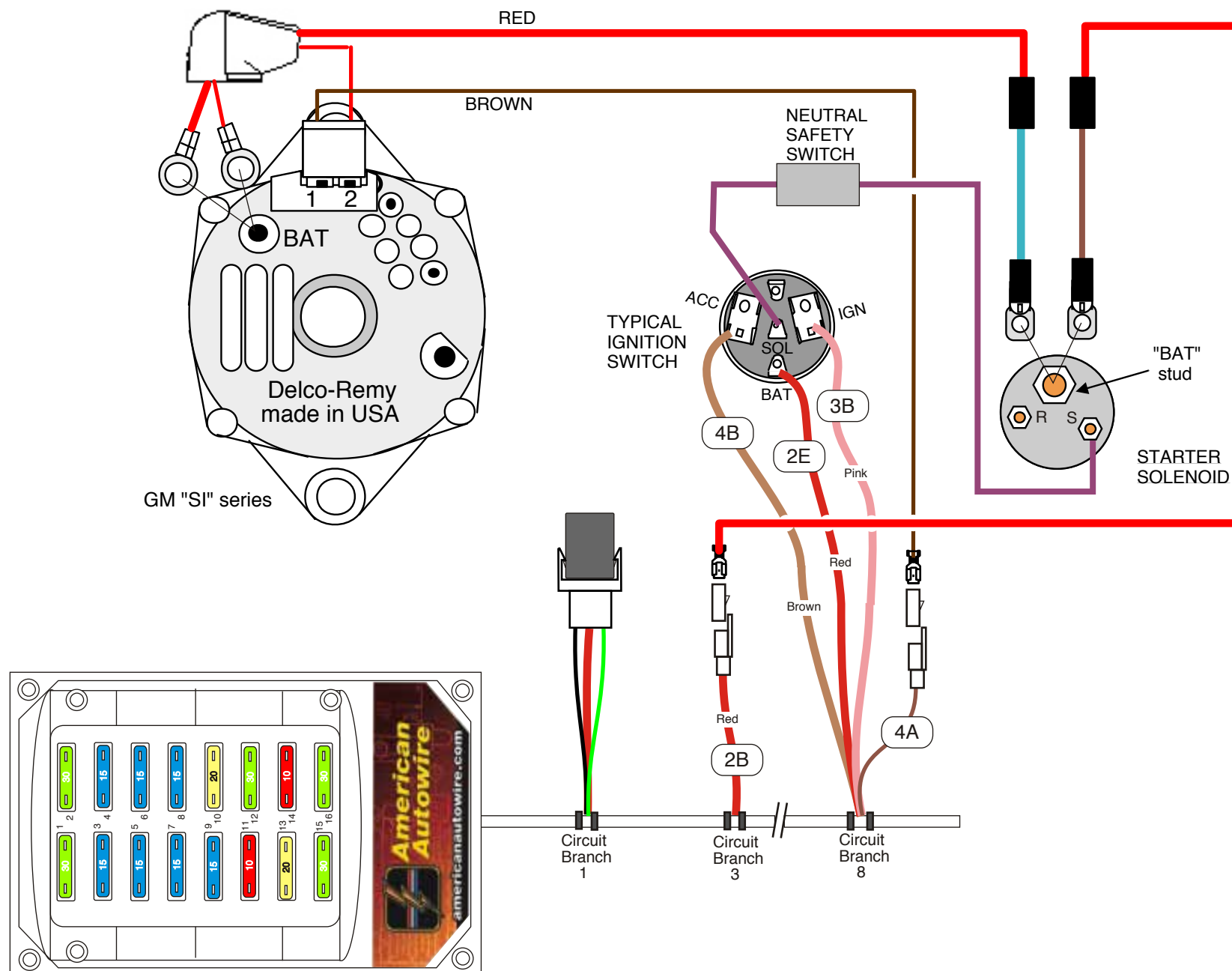

PART #

510006

DESCRIPTION:

**Builder Series 19
Wiring Kit Instructions**

92968422 Instruction sheet rev 1.0 2/23/2012

Circuit Branch 8 - Ignition Switch Connections

These connections were covered on page 5 but will be included here for clarity:

1. Select the red 12 V Battery wire (2E) and connect it to the battery terminal on the ignition switch.
2. Select the pink Ignition Feed wire (3B) and connect it to the ignition terminal on the ignition switch.
3. Select the heavy brown Ignition SW Accessory wire (4B) and connect it to the accessory terminal on the ignition switch.

Circuit Branch 9 - Turn Signal Switch Connections

This kit is designed to function with a GM style turn signal switch. This connector mates to a 3 7/8 inch long plug used on GM columns from 1969-1974. It is also used on many aftermarket steering columns. From 1975 on the GM switch used a 4 1/4 inch connector. The connector is from the same family and uses the same terminals. By using the supplied mating connector it is easy to adapt any GM column to the kit as the color codes and cavity locations for the turn signal switch wires are the same. Orient the turn signal switch connector as shown in the diagram. Notice the letters on the face of the connector. These correspond to the connector cavities. The function of each wire within the cavities is as follows:

wire #	cavity	color	Printing	Function
28	G	Black	Horn Relay Ground	Horn button ground to the horn relay trigger
14A&B	H	Light Blue	Left Front Turn	Feeds the left front turn lamp bulb high filament and the left turn dash indicator lamp.
15A&B	J	Dark Blue	Right Front Turn	Feeds the right front turn lamp bulb high filament and the right turn dash indicator lamp.
27	K	Brown	Turn Sw - Hazard	4 way hazard power feed wire from the Hazard flasher "L" terminal.
16	L	Purple	Turn Switch Feed	Turn signal power feed wire from the Turn Signal flasher "L" terminal.
18	M	Yellow	Left Rear Turn	Feeds the left rear turn and brake lamp bulb high filament.
19	N	Dark Green	Right Rear Turn	Feeds the right rear turn and brake lamp bulb high filament..
17A	P	White	Brake Switch	Power feed wire from the output side of the brake switch.

Circuit Branch 9 - Turn Signal and Hazard Flasher Connections

1. The purple Turn Switch Feed wire (16A) is a 12 volt fused ignition wire from the fuse box to the Turn Signal Flasher "X" terminal.
2. The purple Turn Switch Feed wire (16B) is a 12 volt fused ignition wire from the Turn Signal Flasher "L" terminal to the Turn Signal Switch connector cavity "L".
3. The brown Turn Sw - Hazard wire (27A) is a 12 volt fused battery wire from the fuse box to the Hazard Flasher "X" terminal.
2. The brown Turn Swi - Hazard wire (27B) is a 12 volt fused battery wire from the Hazard Flasher "L" terminal to the Turn Signal Switch connector cavity "K"

Circuit Branch 10 - Radio and Heater Connections

1. The tan Radio wire (43) is a 12 volt fused ignition wire that can be used for the main radio power.
2. The red CB Radio wire (100) is a 12 volt fused accessory wire that can be connected to a CB radio or any other radio function requiring an ignition or accessory power source.
3. The yellow Clock - Bat wire (101) is a 12 volt fused battery wire that can be connected to a clock radio or clock that requires a 12 volt battery power source.
4. The brown Heater/ AC feed wire (50) is connected to the heater or A/C harness ignition power terminal.

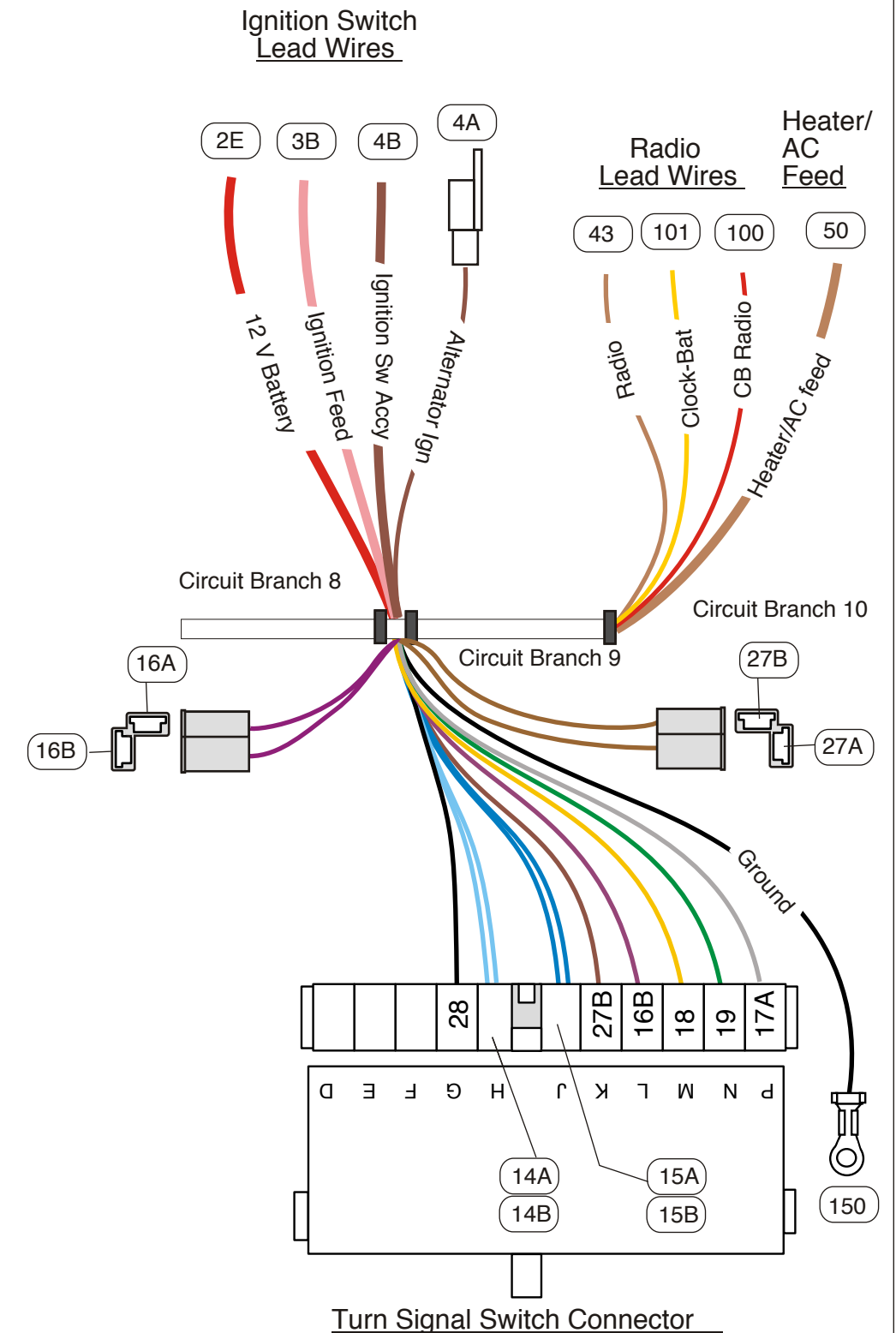

PART #
510006
 DESCRIPTION:
Builder Series 19
Wiring Kit Instructions
 92968422 Instruction sheet rev 1.0 2/23/2012