

Classic Update Series

1967 - 1968 Ford Mustang

START HERE !

PLEASE READ THIS BEFORE STARTING INSTALLATION !

This wiring kit is designed for ease of installation. Please read the guidelines below, BEFORE STARTING your installation to guarantee a successful job. Use an appropriate crimping tool which folds the wings of the open barrel terminals down into the wire as shown below. ALL TERMINALS THAT YOU INSTALL SHOULD BE PROPERLY SOLDERED. Our factory crimped terminations are installed by GM approved five ton presses, and soldering these terminations is not necessary.



AS THIS HARNESS IS DESIGNED FOR USE IN A MODIFIED CAR REQUIRING A HIGHER RATE OF CHARGE, IT DOES NOT SUPPORT THE USE OF A STOCK (ORIGINAL) ALTERNATOR. IT IS DESIGNED FOR USE WITH AN INTERNALLY REGULATED OR SINGLE WIRE STYLE ALTERNATOR. ADAPTERS (WHICH ARE NOT INCLUDED WITH THIS KIT) ARE AVAILABLE FROM SEVERAL SOURCES WILL BE NECESSARY TO USE ANY ALTERNATOR OTHER THAN A 1 WIRE UNIT.

STEP 1: DISCONNECT YOUR BATTERY:

Disconnect the battery before installing the wiring kit to prevent any accidental shorting caused by loose bare wire ends.

STEP 2: START INSTALLING KIT:

This kit is broken down into individual steps that are identified by a letter printed on the instruction sheets visible through each bag. These letters are the order of operation for installing your kit. Start with bag letter G, then M, etc. The order of installation is shown below. Use this instruction sheet, 92968935, to complete the installation instructions.

G - 510047 Dash Harness Kit
M - 510052 Rear Body Kit
N - 510131 Washer Wiper Harness

STEP 3: RECONNECT YOUR BATTERY:

When you have completed the installation and are ready to reconnect the battery, make sure that the following electrical system grounds are in place:

- A. Battery is grounded to the ENGINE BLOCK.
- B. Battery is grounded to the frame.
- C. Engine block is grounded to the frame.
- D. Body is grounded to the frame.

STEP 4: CHECK ALL ELECTRICAL FUNCTIONS:

Any non-functioning items should be checked for proper installation. Any problems with your wiring and electrical circuit functions should be addressed to American Autowire Systems, Inc. as soon as possible to avoid any warranty problems.

If you have any questions concerning this or any of our products, please feel free to call us at 1-856-933-0801.

AMERICAN AUTOWIRE MAKES IT EASY !!

p/n 500649
OEM small terminal crimping
tool (18-14 gauge)



p/n 500523
OEM large terminal crimping
tool (12-8 gauge)



p/n R0067108
OEM style non-stick harness tape



www.americanautowire.com 856-933-0801

PART # **510055**
DESCRIPTION:
**1967-68 Mustang
Classic Update Series Kit**

92968935 Rev 13.0 7/18/2014



American Autowire

www.americanautowire.com 856-933-0801

See page 12 for fuse placement

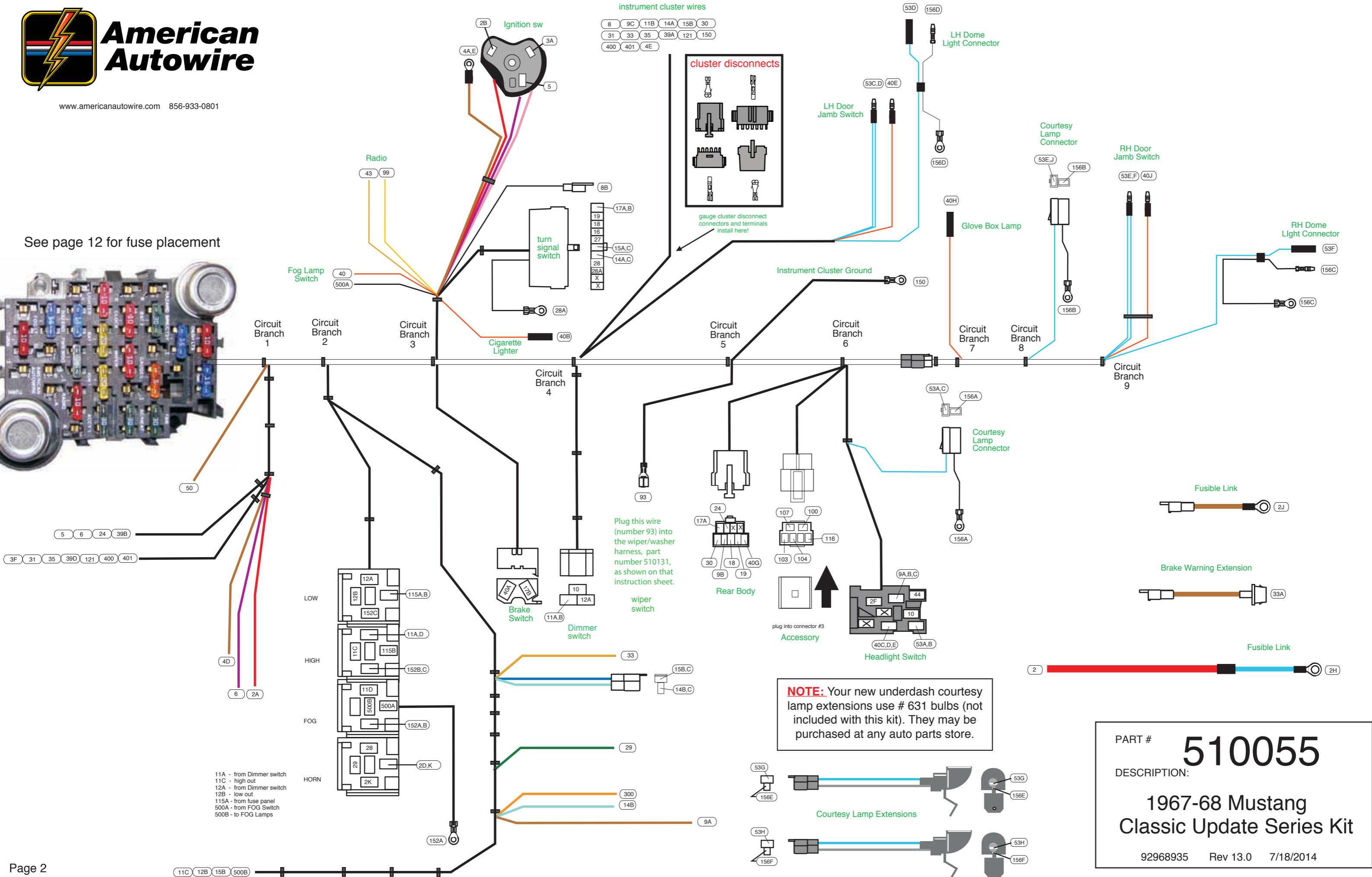
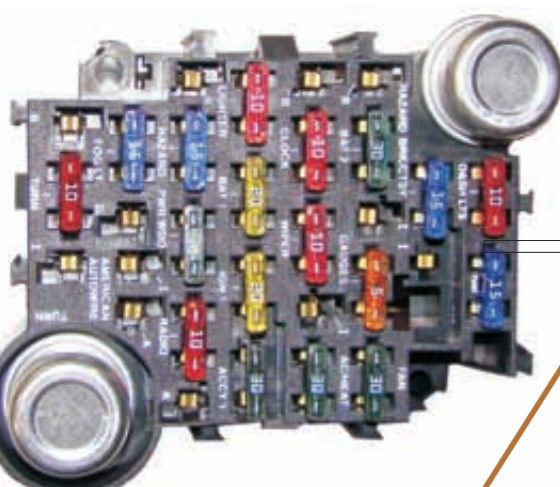

PART # **510055**

DESCRIPTION:
1967-68 Mustang Classic Update Series Kit

92968935 Rev 13.0 7/18/2014

Main Fuse Panel Installation Instructions

The Main Fuse Panel harness is designed to be mounted under the dash at the firewall in an area close to the steering column. The enclosed representation of the main dash harness shows each circuit branch and identifies each connection by its color and function. Follow this drawing and detail drawings on pages 10 and 11 for the individual circuit connections.

Circuit Branch 1 - Engine and Alt. connections.

See pages 10 and 11, "Figures B, C, and D" for typical connections. Loose piece terminals and connectors are located in kit # 510176.

Wire #	Wire color	Printing
50	Brown	Heater/AC feed
6	Purple	Starter Solenoid-S
2	Red	12 V Battery
2H	Light Blue	Fusible Link
2A	Red	12 V Battery
2J	Brown	Fusible Link
5	Purple	Neutral Safety Switch
24	Lt. Green	Backup Lt Sw-Lights
39B	Pink	12 V Ignition
4D	Brown	Alternator Ign
3F	Pink	Ignition Feed - coil
31	Dark Blue	Oil Pressure Sender
35	Dark Green	Water Temp Sender
39D	Tan	Electric Choke
121	White	Coil - Tach
400	Yellow	VSS Ground
401	Purple	VSS Signal

Procedure
 This is the fused Ignition power lead for the heater or AC control panel. Connect according to the instructions supplied with your aftermarket Heater / AC unit. This can also be used as the 12 volt feed wire to the stock 3 speed heater blower motor if you are utilizing your stock 1967-68 Mustang heating system. See page 11, figure E. Connect the end that comes out with the 5, 24, and 39B wires to 1 terminal on the neutral safety switch. Connect the end that comes out with the heavy red power wire to the "S" terminal on your starter solenoid. (See Figure B) Route this wire to your starter solenoid and connect the ring terminal end with the blue fusible link to the battery terminal on the starter solenoid. Route the other end to the alternator battery stud, install sleeve "C" followed by terminal "D" and attach this completed assembly to the battery terminal of the alternator. (See Figure B) See the connection instructions under wire 2.
 Route this wire to your starter solenoid. Cut to length, install terminal "B", plug into connector "E" as shown on this page. As shown on sheet 9, Figure B, plug connector "E" into the connector on the loose piece fusible link wire 2J, then attach the ring terminal on this assembly to the battery terminal on your starter solenoid. (Parts in 510047 kit) See the connection instructions under wire 2A.
 Connect to the opposite terminal from wire 6 above to a terminal on the neutral safety switch. (See figure C)
 Connect to the backup light terminal on the neutral safety / back up switch. (See figure C)
 Connect to the backup light power terminal on the neutral safety / back up switch. (See figure C)
 This wire is the exciter wire for your alternator / voltage regulator. If you are using a one wire alternator, this wire will not be used and should be capped off as it is "hot" in the ignition "on" position. If you are using an alternator that requires an internal or external voltage regulator, this exciter wire must be connected to the "switched or 12v ignition" terminal on your regulator or alternator according to the manufacturer's specifications for the type of alternator / regulator that is being used. (AAW recommends a GEN 3 Internally Regulated or 1 wire unit)
 This is your 12 volt switched power source for the distributor. This can be connected directly to the "bat" terminal on a typical HEI distributor, to a ballast resistor as in a points type distributor, or be used as the ignition power source for an aftermarket ignition module such as an MSD or "Duraspark" module. See the installation instructions for the type of distributor you are using for specific connection requirements (See page 10 for some examples).
 Connect to the oil pressure sender.
 Connect to the temperature sender.
 On carbureted cars, connect to the electric choke terminal.
 This can be connected directly to the tach terminal on a typical HEI distributor, to the negative side of the coil, or a tach connection in an aftermarket ignition module such as an MSD module. See the installation instructions for the type of ignition system you are using for specific connection requirements.
 Connect to the Vehicle Speed Sensor ground lead (see page 4 for typical connection).
 Connect to the Vehicle Speed Sensor signal lead (see page 4 for typical connection).

Circuit Branch 2- Front Lighting connections.

See page 10, "Figure A" for typical connections. Loose piece terminals and connectors are located in kit 510176.

Wire #	Wire color	Printing
		Relay Pack
152A	Black	Ground
33	Tan	Brake Switch
14B,C	Light Blue	Left Front Turn
15B,C	Dark Blue	Right Front Turn
29	Dark Green	Horn
14B	Light Blue	Left Front Turn
15B	Dark Blue	Right Front Turn
300	Orange	Electric Fan
9A	Brown	Park Lights
11C	Light Green	Headlight-Hi Beam
12B	Tan	Headlight-Low Beam
500B	Black	Fog Lamps

Procedure
 The 4 gang relay panel is directly wired and requires no internal wiring. The relays control the headlight low beams, headlight high beams, fog lamps, and the horn.
 This is the relay pack ground. Connect to a good chassis ground.
 This is the brake warning light switch wire for braking systems using a brake warning light. An extension to the switch, wire "33A" with a late model mold-on connector, has also been provided. Route wire 33 to the brake warning switch, cut to length, install terminal "E", plug into connector "B" (Parts in 510047 kit), plug the completed lead into the brake warning extension wire 33A. The other end of the brake warning extension can then be plugged onto the brake warning switch.
 These are the connections for the hood mounted directional lights. The mating connector and terminals "B and Q" to complete this branch can be found in the 510047 loose piece dash kit if you are using a stock hood with these lamps. Connect to the horn power terminal. NOTE: If your horn has a separate ground terminal, you must supply the wire for this ground terminal as it is not included in the kit.
 Connect to the left front directional lamp socket. If you are using a single front directional light with an 1157 or dual filament bulb, this wire would be connected to the high intensity filament of the LH front running light.
 Connect to the right front directional lamp socket. If you are using a single front directional light with an 1157 or dual filament bulb, this wire would be connected to the high intensity filament of the RH front running light.
 This is the 12 volt ignition feed to be connected to the trigger wire on your electric fan relay.
 Connect to both the front park / running light sockets. If you are using a single front directional light with an 1157 or dual filament bulb, this wire would be connected to the low intensity filament of each of the front running lights. An in-line splice of this wire or a double up of this wire at the left front parking lamp will be necessary to accommodate the wiring of both of the front park / running lights
 Select the light green Headlight Hi Beam wire (11C) and tan Headlight Low Beam wire (12B). Route and connect these wires to the headlights. An in-line splice of these wires or a double up of these wires at the left front headlight will be necessary to accommodate wiring of both of the headlights. Using the supplied terminals and connectors, connect these wires along with the headlight ground wires to the headlight connectors according to the orientation in the diagram on page 9, Figure A.
 Connect this wire to your fog lamp power wires. An in-line splice or double up of the wire at the left fog lamp before routing to the right fog lamp will be necessary. If the fog lamps have a separate ground wire, you must supply those wires as they are not included in the kit.

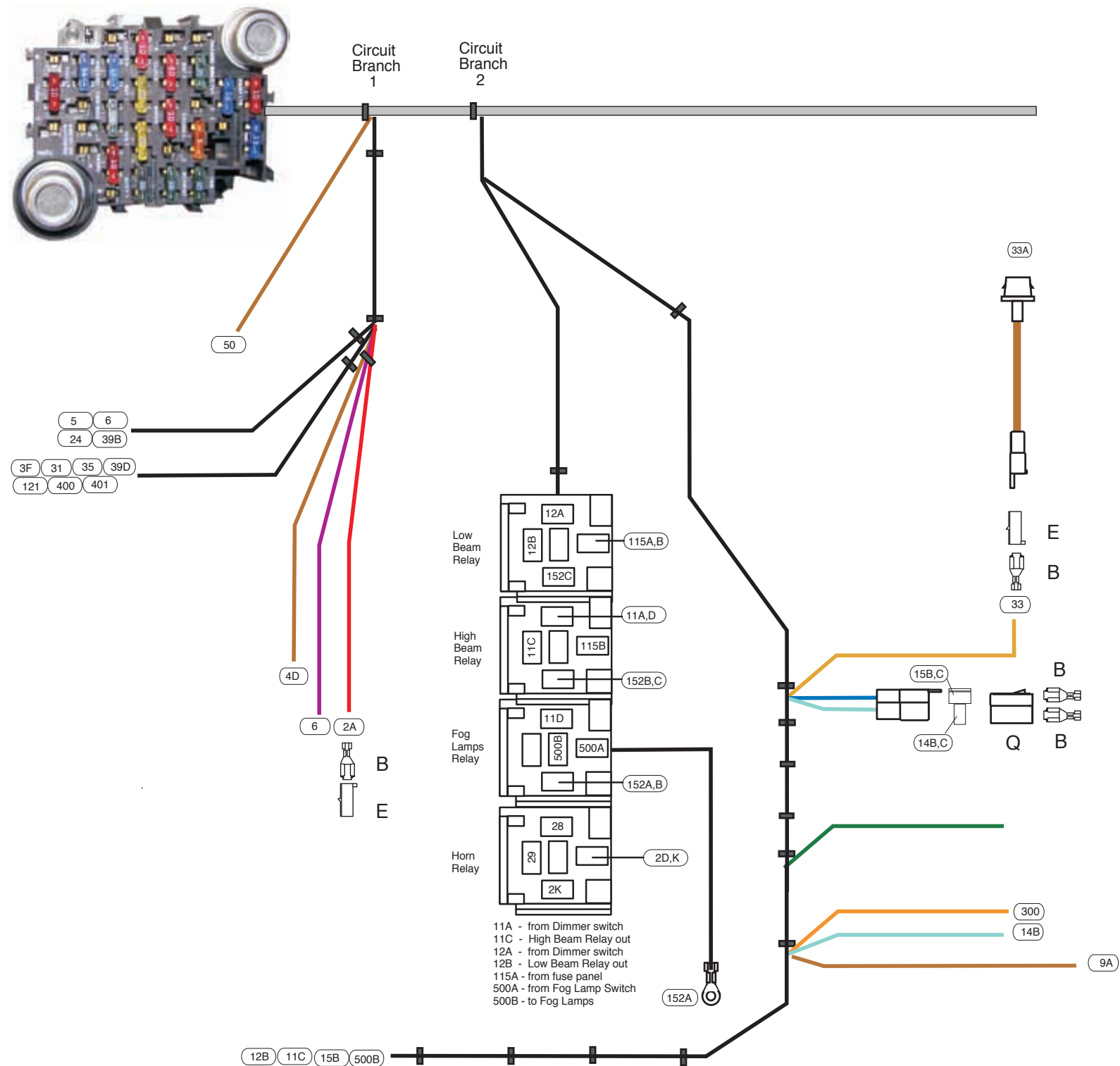

PART # **510055**
 DESCRIPTION:
1967-68 Mustang Classic Update Series Kit
 92968935 Rev 13.0 7/18/2014

Circuit Branch 3 - Under Dash connections

Wire #	Wire color	Printing	Procedure
40	Orange	12V Battery Fused	Connect to "Feed In" on your fog lamp switch (if so equipped). Connect to "Feed out" on your fog lamp switch (if so equipped). Ignition power lead to radio. Battery power lead to radio. Used for original Ford steering column only. See Table "A" - Stock turn signal connection instruction table. Connect to cigarette lighter. Spare dash lamp feed for any accessory dash lamps needed.
500A	Black	Fog Lamps	
43	Tan	Radio	
99	Yellow	Radio Bat	
28A	Black	Horn Relay Ground	
40B	Orange	12V battery Fused	Connect to Brake Switch. Connect to Brake Switch.
8B	Gray	Dash Lights	
Brake Switch connector			
40A	Orange	12V battery Fused	Connect to the provided 1967 style ignition switch.
17B	White	Brake Switch	
Ignition Switch connector			
3A	Pink	Ignition Feed	Install on the ignition switch stud after the main switch connector has been plugged in.
5	Purple	Neutral Safety Switch	
2B	Red	12V Battery	
4A,E	Brown	Ignition Sw Accy	

Turn Signal Switch connector

If you are using a stock Ford turn signal switch, refer to Page 9, Diagram 'A' and Table "A", AAW Turn Signal Switch wires to stock 1967-68 Mustang turn signal switch. This kit is designed to function with a GM style turn signal switch. Our connector mates to a 3 7/8 inch long plug used on 1969-1974 GM, IDIDIT, and many other aftermarket steering columns. Starting from 1975 on up, the GM switch changed the mating connector to use a 4 1/4 inch connector. That connector is from the same family and uses the same terminals. By using the supplied mating connector (L) and terminals (M) located in the loose piece kit bag of this dash harness (510047), it is easy to adapt any steering column to the kit. The function of each wire within the cavities is as follows:

Wire #	Wire color	Printing	Procedure
28	Black	Horn Relay Ground	Horn button ground to the horn relay trigger
14A,C	Light Blue	Left Front Turn	Feeds the left front turn lamp bulb high filament ,the left hood mounted turn signal bulb, and the left turn dash indicator lamp.
15A,C	Dark Blue	Right Front Turn	Feeds the right front turn lamp bulb high filament, the right hood mounted turn signal bulb, and the right turn dash indicator lamp.
27	Brown	Turn Sw - Hazard	4 way hazard power feed wire from the Hazard flasher "L" terminal.
16	Purple	Turn Switch Feed	Turn signal power feed wire from the Turn Signal flasher "L" terminal.
18	Yellow	Left Rear Turn	Feeds the left rear turn and brake lamp bulb high filament.
19	Dark Green	Right Rear Turn	Feeds the right rear turn and brake lamp bulb high filament..
17A	White	Brake Switch	Power feed wire from the output side of the brake switch.

Circuit Branch 4 - Under Dash connections

Wire #	Wire color	Printing	Procedure
Dimmer Switch connector.			
10	Yellow	Dimmer Switch Feed	Connect to Dimmer Switch.
11A,B	Light Green	Headlight Hi Beam	Connect to Dimmer Switch.
12A	Tan	Headlight Low Beam	Connect to Dimmer Switch.
Left Hand Dome Lamp Feed Wires.			
53C,D	Light Blue	12V Ctsy Sw	Connect to Left Hand door jamb switch.
40E	Orange	12V Battery Fused	Connect to Left Hand door jamb switch.
53D	Light Blue	12V Ctsy Sw	Connect to Left rear dome lamp.
156D	White	Ctsy Ground	Connect the bullet terminal end to the left rear dome lamp. The ring terminal end must be connected to a good chassis ground.

Instrument Cluster wires.

See Page 9 - Table 'B' for stock 1967-68 Mustang instrument cluster wiring colors and functions. **Cluster disconnects** have been provided and can be found in the 510047 loose piece bag. We have provided an ample length of wire in order for you to cut an make your own gauge cluster harness. Page 45 identifies a typical instrument cluster wiring scheme. As this kit is designed to function with many different gauge manufacturer's products, it may be necessary to follow the connection requirements specified by the manufacturer of the gauges being used. **As with all AAW kits, the use of a factory ammeter is neither supported, nor is it encouraged.** The function of each AAW wire is as follows:

8	Gray	Dash Lights	Connect to Gauge Lights.
9C	Brown	Park Lights	Connect to any instrument cluster requiring a signal to dim a digital display.
11B	Light Green	Headlight Low Beam	If using regular analog gauges, this wire will not be required.
14A	Light Blue	Left Dash Ind	Connect to the high beam indicator light.
15B	Dark Blue	Right Dash Ind	Connect to the left turn signal indicator light.
30	Tan	Gas Gauge	Connect to the right turn signal indicator light.
31	Dark Blue	Oil Pressure Sender	Connect to the signal or sender terminal of the fuel gauge.
33	Tan	Brake Light	Connect to the signal or sender terminal of the oil pressure gauge.
35	Dark Green	Water Temp Sender	Connect to the ground side of the brake warning indicator light.
39A	Pink	12V Ignition	Connect to the signal or sender terminal of the water temperature gauge.
121	White	Coil-Tach	Connect to the Ignition or power terminals of each gauge. An in line splice will be necessary to feed each gauge in the instrument cluster.
150	Black	Ground	Connect to the signal or sender terminal of the tachometer.
400	Yellow	VSS Ground	Connect to the Ground terminals of each gauge and dash lamp. An in line splice will be necessary to feed each ground requirement in the instrument cluster.
401	Purple	VSS Signal	connect to a good chassis ground or the VSS ground terminal on the speedometer.
4E	Brown		Mechanical speedometers do not require this connection.
			Connect to the VSS signal or sender terminal of the speedometer.
			Mechanical speedometers do not require this connection.
			This wire will only be used when installing a stock instrument cluster. Connect to the Black with light green stripe wire when using a stock 1967 or 1968 Mustang instrument cluster. This is the accessory feed for the voltage reducer for certain stock gauges.

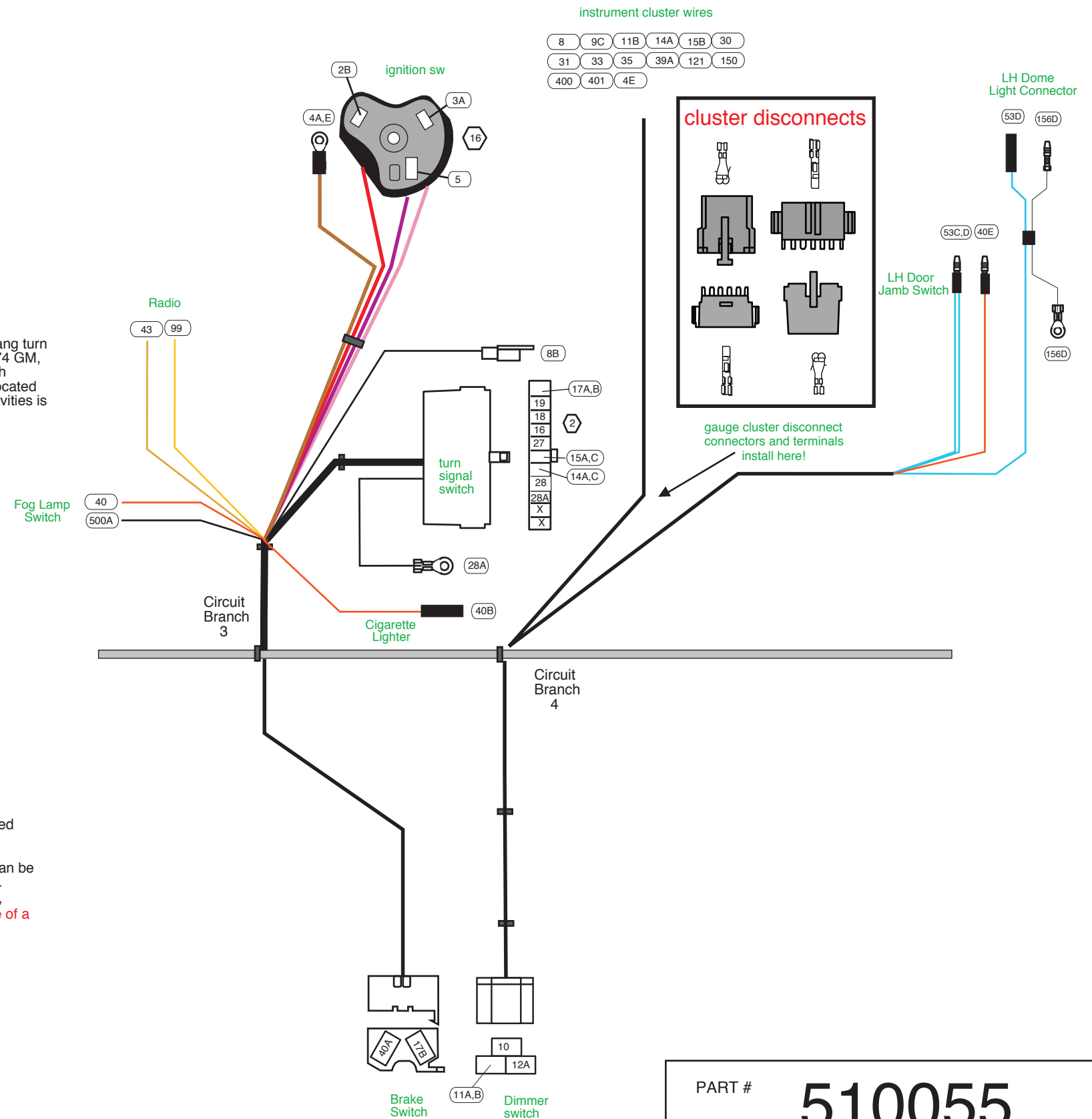

PART # **510055**

DESCRIPTION:

1967-68 Mustang Classic Update Series Kit

92968935 Rev 13.0 7/18/2014

TYPICAL BLADE TYPE GAUGE CONNECTIONS

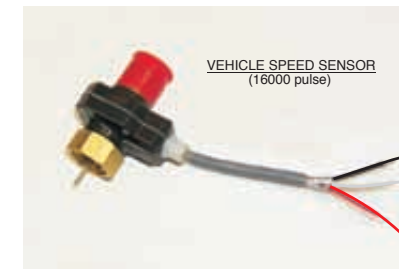
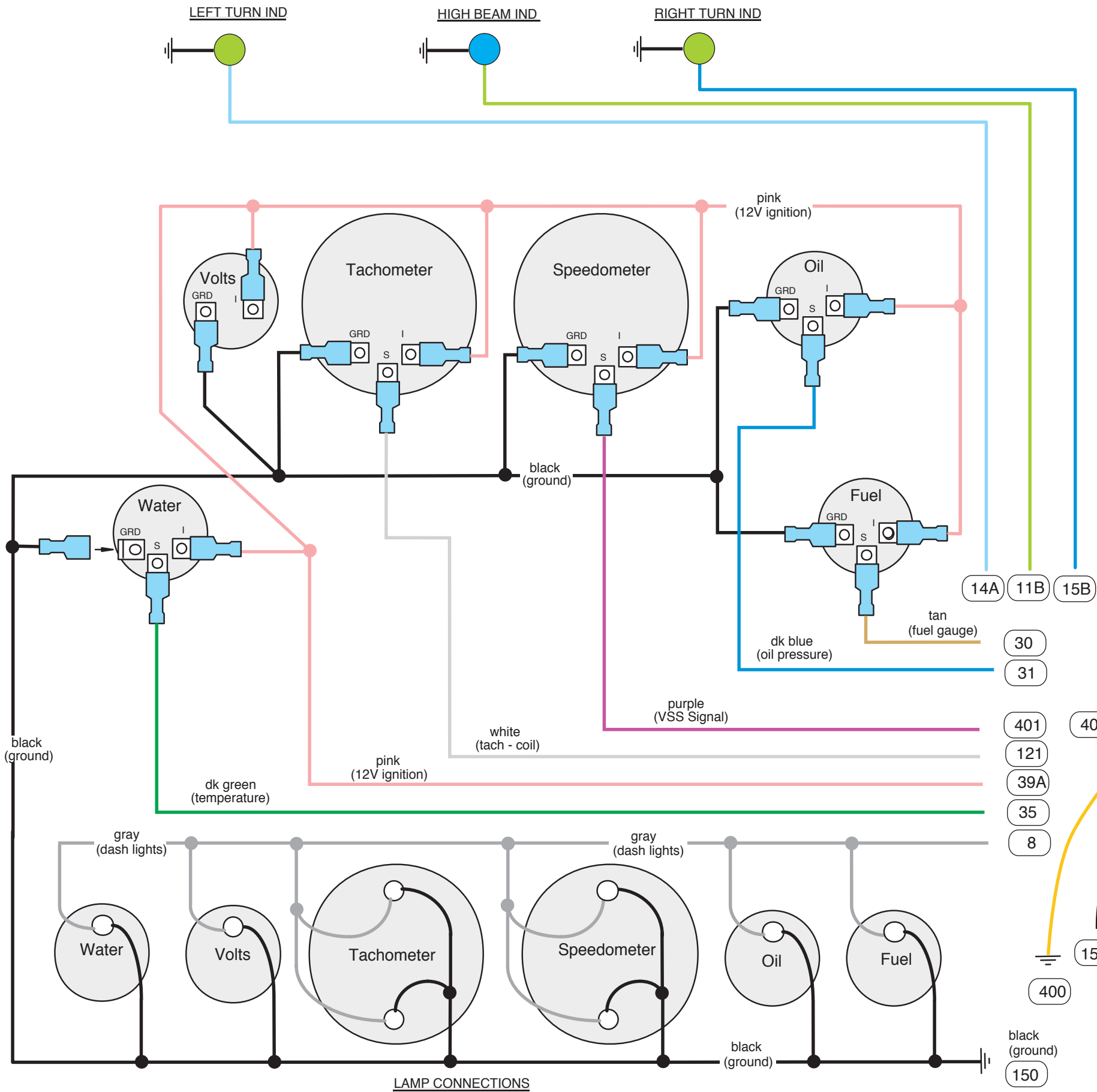

Typical 3 wire Autometer 5291 VSS connection

Note: This VSS requires a lead wire from the red wire to a 12 volt ignition source. This wire is not included in the kit.

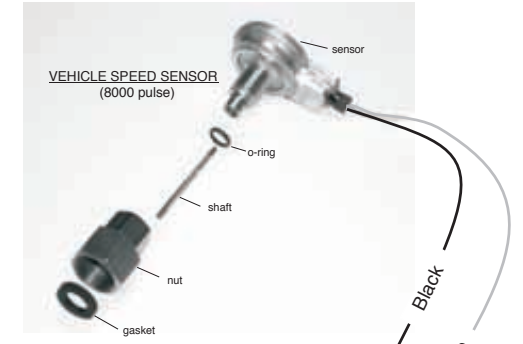

Typical 2 wire VSS connection

connect to 12 volt ignition source

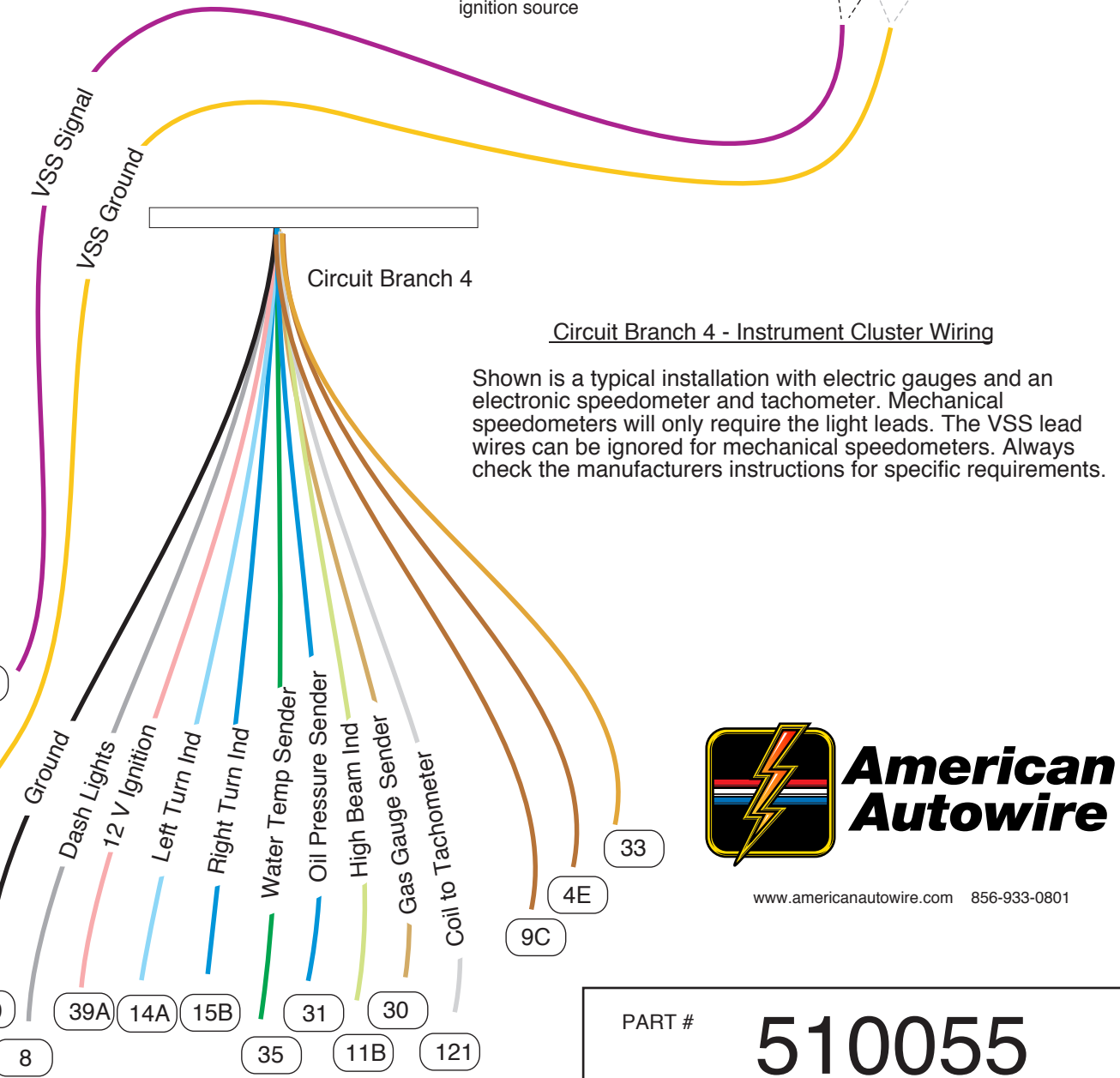

www.americanautowire.com 856-933-0801

PART # **510055**

DESCRIPTION: **1967-68 Mustang Classic Update Series Kit**

92968935 Rev 13.0 7/18/2014

Circuit Branch 5 - Under Dash connections

Wire #	Wire color	Printing	Procedure
Wiper Switch connections.			
93	White	Wiper Feed	Power input to wiper and washer switch connection. (This wire and terminal will attach to AAW harness number 510131, "Wiper Washer Harness", to complete your stock windshield wiper harness system. The instructions for the motor and pump connections, as well as the instructions on where to plug this wire into the "Wiper Washer Harness" can be found on instruction sheet number 510131.)
150	Black	Ground	Instrument Cluster ground. Connect to a good chassis ground.

Circuit Branch 6- Under Dash connections

Wire #	Wire color	Printing	Procedure
Rear Body Wire connections. This plugs into the Rear Body Kit 510052. See that sub-kit for specific installation instructions and circuit functions.			
Accessory Feed Wire connections.			
100	Tan	Accessory Fused	Accessory Fused power source.
103	Tan	Fuel pump	Connect to the power input terminal of a fuel pump relay.
104	Red	Power Locks	Connect to the power input of the power locks switch or any other battery powered accessory.
107	Pink	Ignition Fused	Ignition Fused power source.
116	Pink	Power Windows	Connect to the power input of the power windows switch or any other ignition powered accessory.
Headlight switch connector. The function of each wire is as follows:			
2F	Red	12V Battery	12 volt battery power to the switch.
9A,B,C	Brown	Park Lights	Power lead wires to the running light circuits.
44	Dark Green		Power lead wire to the dash lights .
10	Yellow	Dimmer Sw feed	Headlight power output to the Dimmer Switch.
40C,D,E	Orange	12V Battery Fused	Courtesy Light battery power
53A,B	Lt Blue	12V Ctsy Sw	Courtesy Light switched battery power

Courtesy light connector. Plug in your Left Hand under dash courtesy lamp assembly here. The function of each wire is as follows:			
53A,C	Lt Blue	12V Ctsy Sw	Courtesy Light power.
156A	White	Crtsy ground	Courtesy Light ground

Circuit Branch 7- Under Dash connections

Wire #	Wire color	Printing	Procedure
40H	Orange	12V Battery Fused	Connect to the glove box lamp assembly.

Circuit Branch 8- Under Dash connections

Wire #	Wire color	Printing	Procedure
Courtesy light connector. Plug in your Right Hand under dash courtesy lamp assembly here. The function of each wire is as follows:			
53E,J	Lt Blue	12V Ctsy Sw	Courtesy Light power.
156B	White	Crtsy ground	Courtesy Light ground

Circuit Branch 9- Under Dash connections

Wire #	Wire color	Printing	Procedure
Right Hand Dome Lamp Feed Wires.			
53E,F	Light Blue	12V Ctsy Sw	Connect to the Right Hand door jamb switch.
40J	Orange	12V Battery Fused	Connect to the Right Hand door jamb switch.
53F	Light Blue	12V Ctsy Sw	Connect to the Right rear dome lamp.
156C	White	Ctsy Ground	Connect the bullet terminal end to the right rear dome lamp. The ring terminal end must be connected to a good chassis ground.

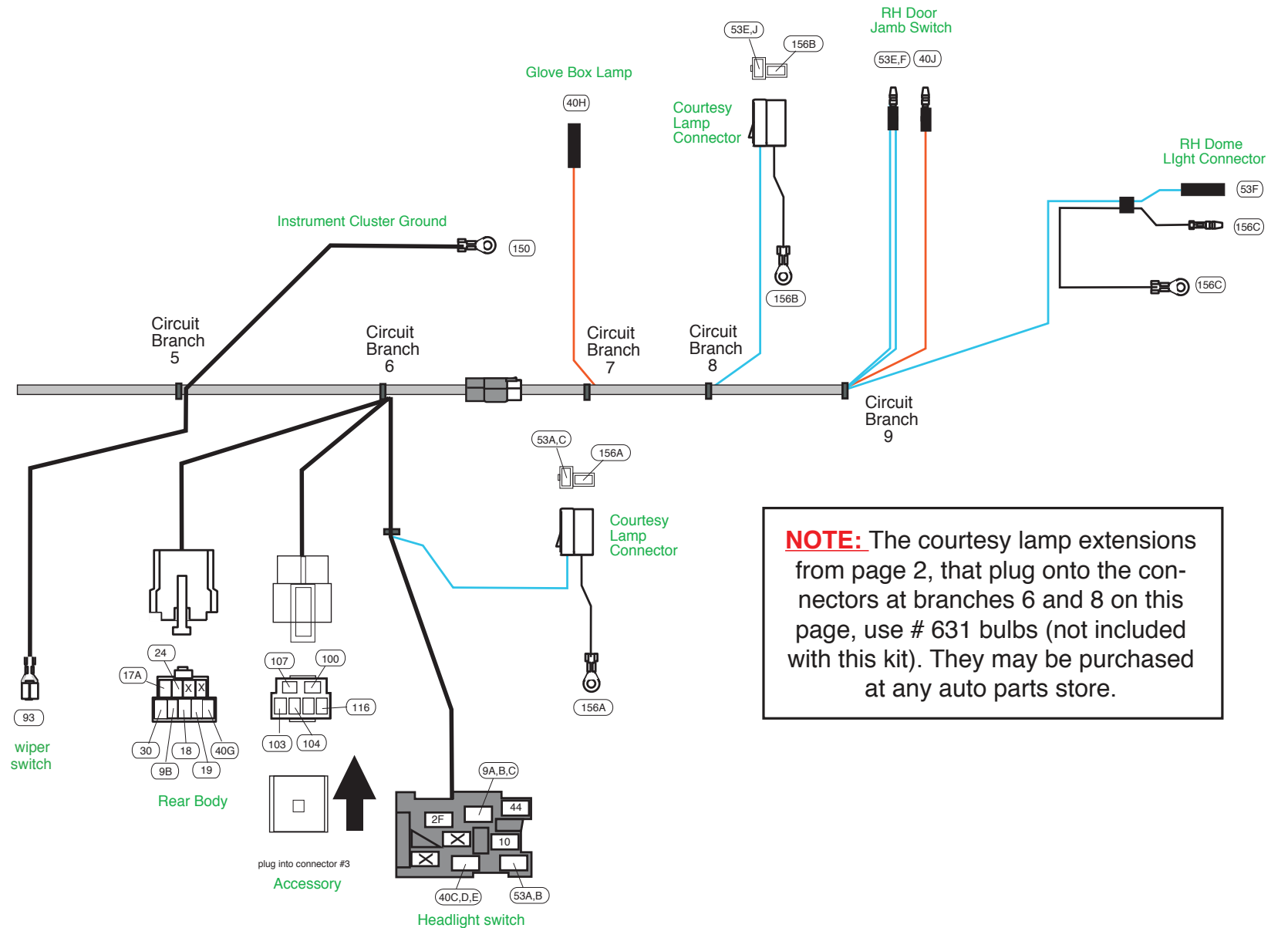

NOTE: The courtesy lamp extensions from page 2, that plug onto the connectors at branches 6 and 8 on this page, use # 631 bulbs (not included with this kit). They may be purchased at any auto parts store.



www.americanautowire.com 856-933-0801

PART # **510055**
 DESCRIPTION:
1967-68 Mustang Classic Update Series Kit
 92968935 Rev 13.0 7/18/2014

Engine Bay Side

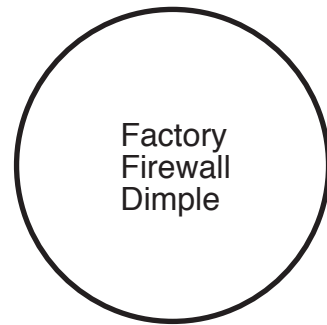
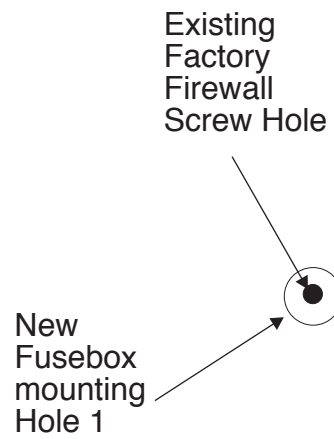
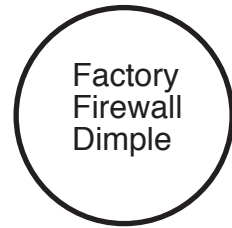
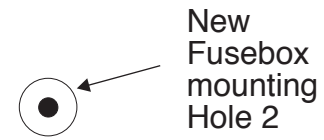

Fusebox Mounting Hole Template

Hole 2 needs to be drilled in the firewall for the new fuse box.

Position the template from either the engine bay side or the under dash side.

Locate the existing firewall screw hole that will set the center point for the new fuse box Hole 1. This hole is already the correct size for the new fuse box retention screw.

The template can then be used to set the center point to drill the 1/8 inch hole for the new fuse box Hole 2.

Under Dash Side

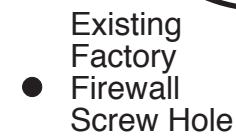
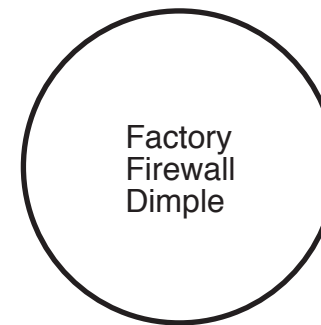
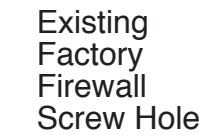
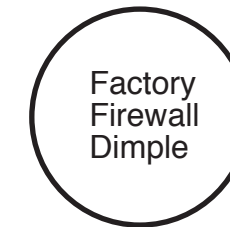
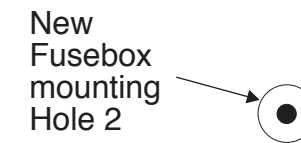

**American
Autowire**

www.americanautowire.com 856-933-0801

PART #

510055

DESCRIPTION:

1967-68 Mustang
Classic Update Series Kit

92968935 Rev 13.0 7/18/2014

Ignition switch, turn signal switch, radio, fog light switch, and cigar lighter wires, etc., all drop down on the right side of the steering column saddle.

Heat and AC feed, instrument cluster, headlight switch, accessory connections, rear body, wiper switch, dimmer switch, glove box, and courtesy light wires all route over the top of the steering column saddle to keep everything away from the wiper transmissions (moving linkage).

The front light wiring goes out through the stock hole in the firewall ahead of the headlight switch.

Harness routes down the firewall next to saddle and around the fresh air plenum.

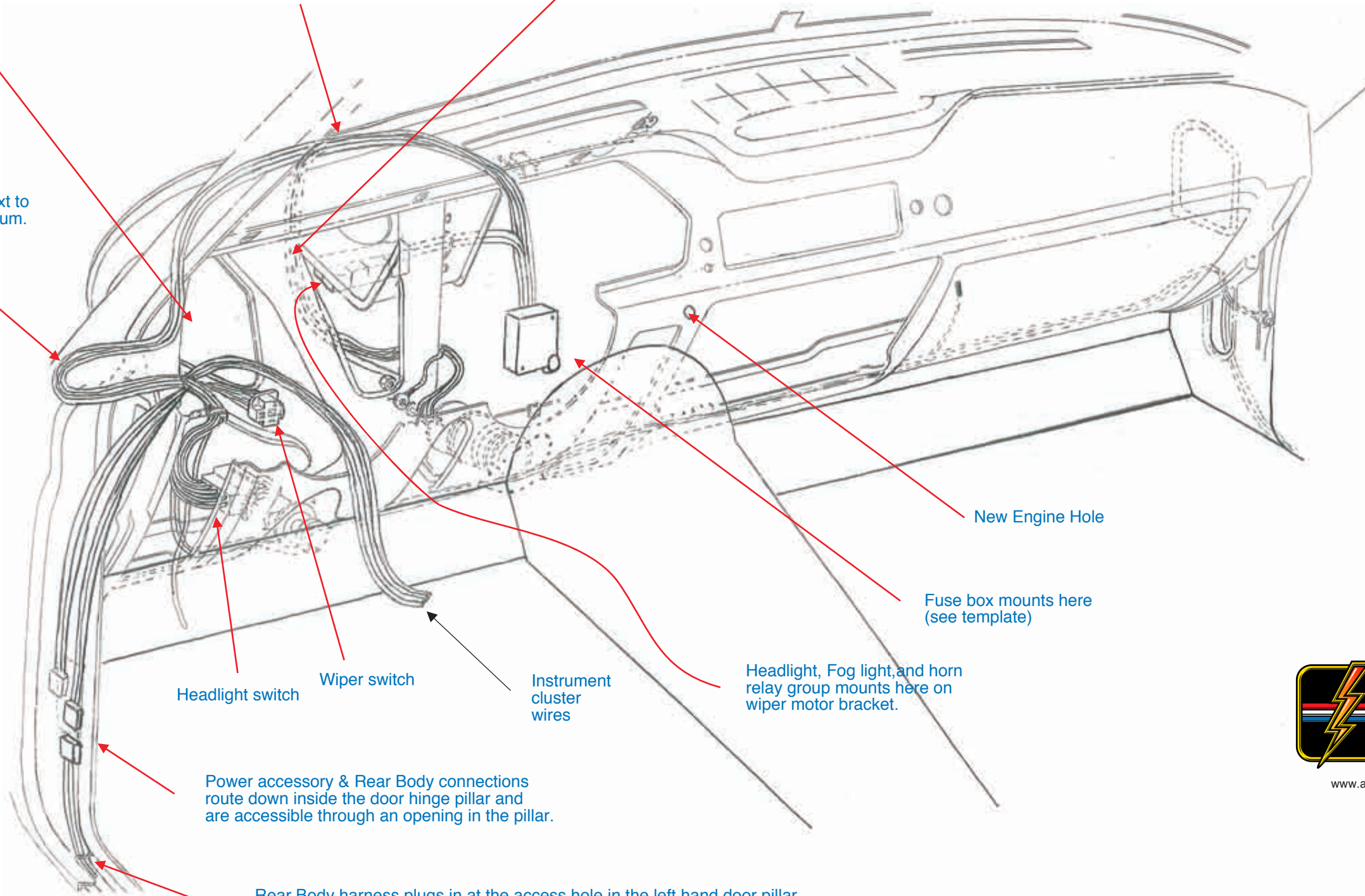

New Engine Hole

Fuse box mounts here (see template)

Headlight, Fog light, and horn relay group mounts here on wiper motor bracket.

Instrument cluster wires

Wiper switch

Headlight switch

Power accessory & Rear Body connections route down inside the door hinge pillar and are accessible through an opening in the pillar.

Rear Body harness plugs in at the access hole in the left hand door pillar and routes down through the channel, along the rocker sill, into the left quarter panel, and up over the wheel housing and into the trunk.



www.americanautowire.com 856-933-0801

PART # **510055**

DESCRIPTION:

**1967-68 Mustang
Classic Update Series Kit**

92968935 Rev 13.0 7/18/2014

Table 'A' -
AAW Turn Signal Switch wires to
stock 1967-68 Mustang turn signal switch.

AAW Wire #	AAW Wire color	AAW Wire Printing	Ford Wire Color
14A	Light Blue	Left Front Turn	Green with white stripe
15B	Dark Blue	Right Front Turn	White with blue stripe.
16	Purple	Turn Switch Feed	Blue
17A	White	Brake Switch	Green
18	Yellow	Left Rear Turn	Green with orange stripe.
19	Dark Green	Right Rear Turn	Orange with blue stripe.
27	Brown	Turn Sw - Hazard	White with red stripe.
28	Black	Horn Relay Ground	Yellow
28A	Black	Horn Relay Ground	Blue with yellow stripe.

Note: Ford originally switched power to the horns through the steering column horn button. In this kit, ground is being switched through the original steering column switch to ground a horn relay which switches power to the horns.

Table 'B' -
AAW Instrument Cluster Kit wires to
stock 1967-68 Mustang instrument cluster wires.

AAW Wire #	AAW Wire color	AAW Wire Printing	Ford Wire Color
4E	Brown		Black with light green stripe This is the accessory feed for the voltage reducer for certain stock gauges.
8	Gray	Dash Lights	Blue with red stripe.
9C	Brown	Park Lights	Connect to any instrument cluster requiring a signal to dim a digital display. When using analog gauges, this wire will not be required.
11B	Light Green	Hi Beam Ind	Green with black stripe.
14A	Light Blue	Left Dash Ind	Green with white stripe.
15B	Dark Blue	Right Dash Ind	White with blue stripe.
30	Tan	Gas Gauge	Yellow with white stripe.
31	Dark Blue	Oil Pressure Sender	White with red stripe.
33	Tan	Brake Light	Purple with white stripe.
35	Dark Green	Water Temp Sender	Red with white stripe.
39A	Pink	12V Ignition	Red with yellow stripe
121	White	Coil-Tach	Sender terminal of the tachometer.
150	Black	Ground	Connect to the Ground terminals of each gauge and dash lamp. An in line splice is necessary to feed each ground requirement in the instrument cluster.
400	Yellow	VSS Ground	Connect to a good chassis ground or the VSS ground terminal on an electronic speedometer. Mechanical speedometers do not require this connection.
401	Purple	VSS Signal	Connect to the VSS pulse signal or sender terminal of the electronic speedometer. Mechanical speedometers do not require this connection.
99	Yellow	Radio Bat	Light blue with white stripe or light blue with black stripe. This is the 12 volt feed for the dash clock. If you are using a radio with a digital clock, it will be necessary to splice into this wire to create 2 leads. One to the dash clock, and one to the radio.

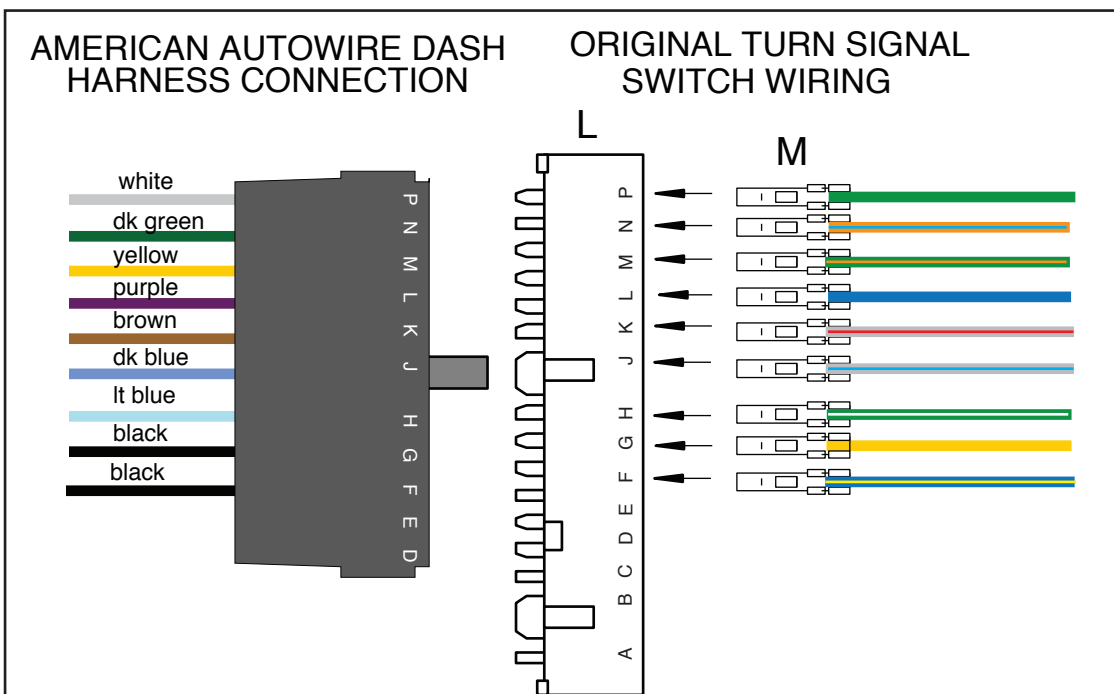

**DIAGRAM 'A' - AAW Turn
Signal Switch Wires to Stock
1967-68 Steering Columns.**



www.americanautowire.com 856-933-0801

PART # **510055**

DESCRIPTION:

**1967-68 Mustang
Classic Update Series Kit**

92968935 Rev 13.0 7/18/2014

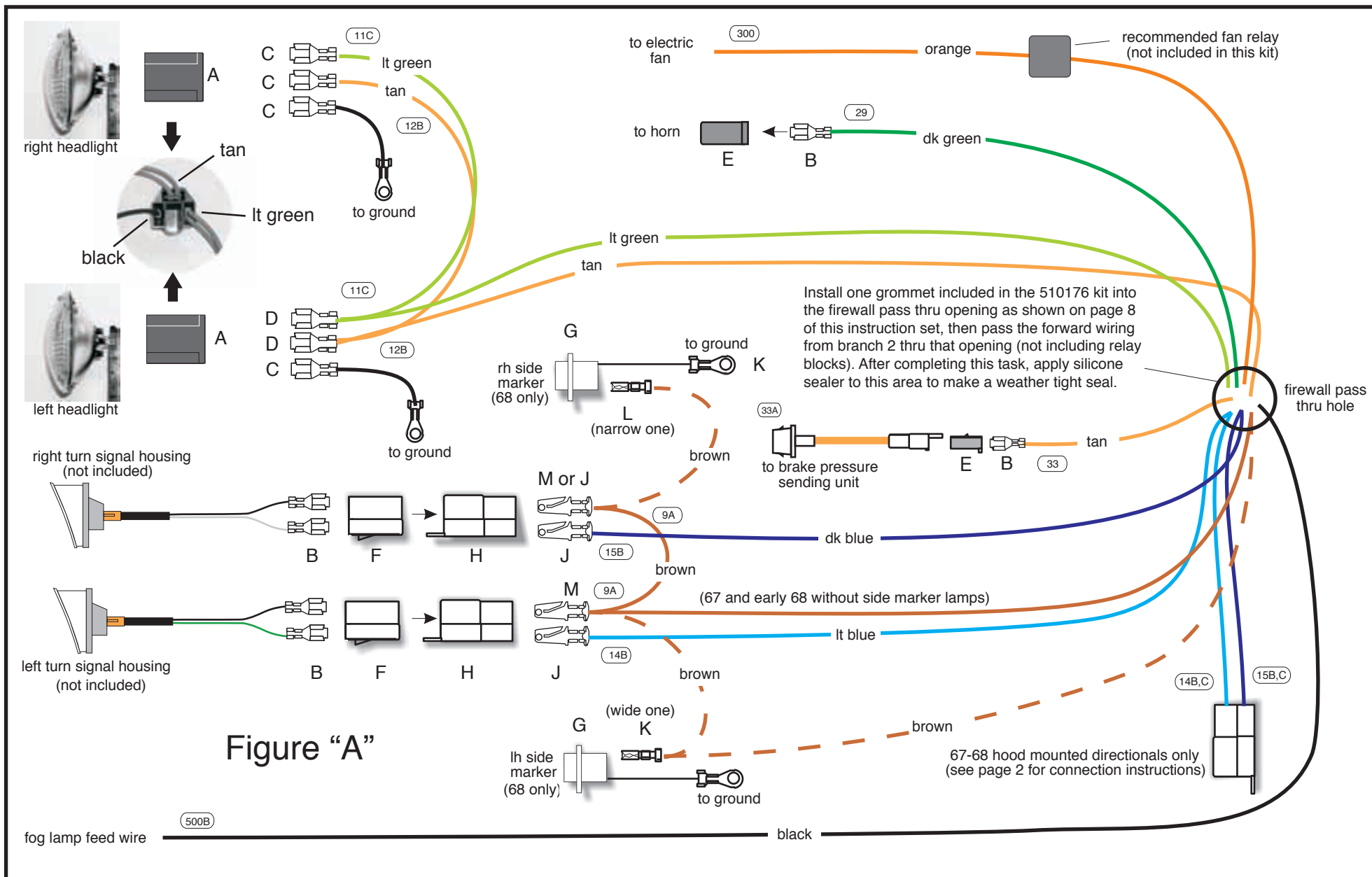

NOTE: The terminals and connectors listed on this page and denoted with **UPPER CASE LETTERS** to help you complete the various connections to your lamps, horns, switches, etc. can be found in your loose piece grommet and parts kit, P/N 510176.

The identifications, colors, and functions for all of the wires listed in "Figures A, B, and C" on this page can be found on page 3, branches 1 and 2 of this main instruction set. AAW suggests and recommends using both pages 3 and 10 to complete the installation of the forward lamp, main power, alternator power, and neutral safety connections.

AAW kits are all engineered to be used in conjunction with a high output, later model internally regulated, or one wire alternator. We do not suggest or support the use of a stock low amperage generator or alternator as they do not supply sufficient current to recharge the battery in a highly modified car such as this kit was designed for. AAW suggests a Ford Gen III type alternator as a good choice of an alternator to use. An adapter to complete the connection to this style alternator, our P/N 500802, may be purchased separately if needed. Contact our Sales Group or your favorite retailer to purchase this alternator adapter if needed.

Figure "A"

Main system power feed and alternator power feed connections.

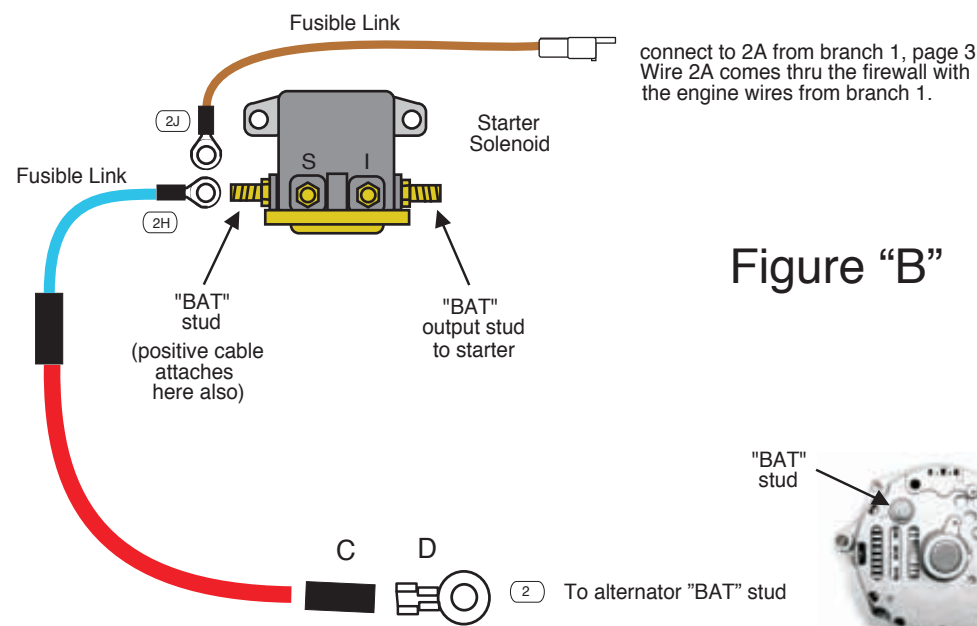
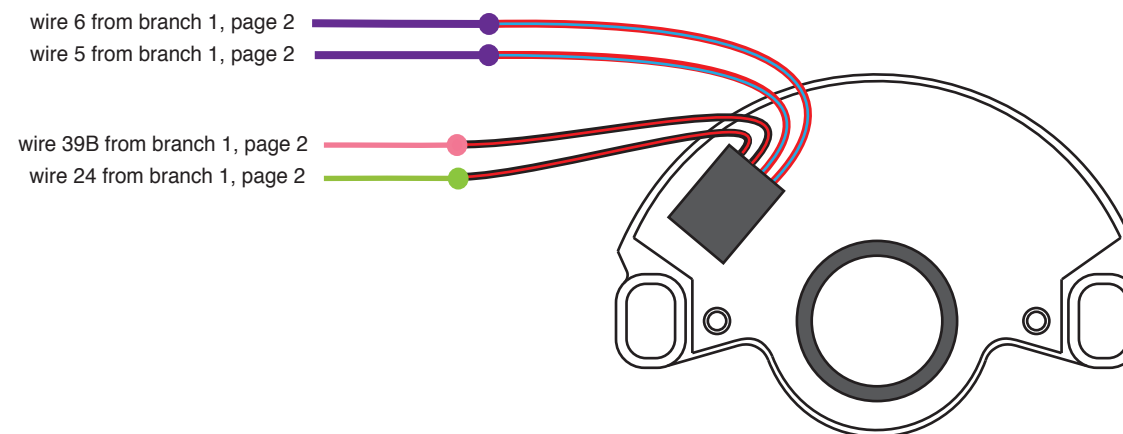

Figure "B"

Figure "C"

Shown is a typical NSS and Back Up Switch.



www.americanautowire.com 856-933-0801

PART # **510055**

DESCRIPTION:

**1967-68 Mustang
Classic Update Series Kit**

92968935 Rev 13.0 7/18/2014

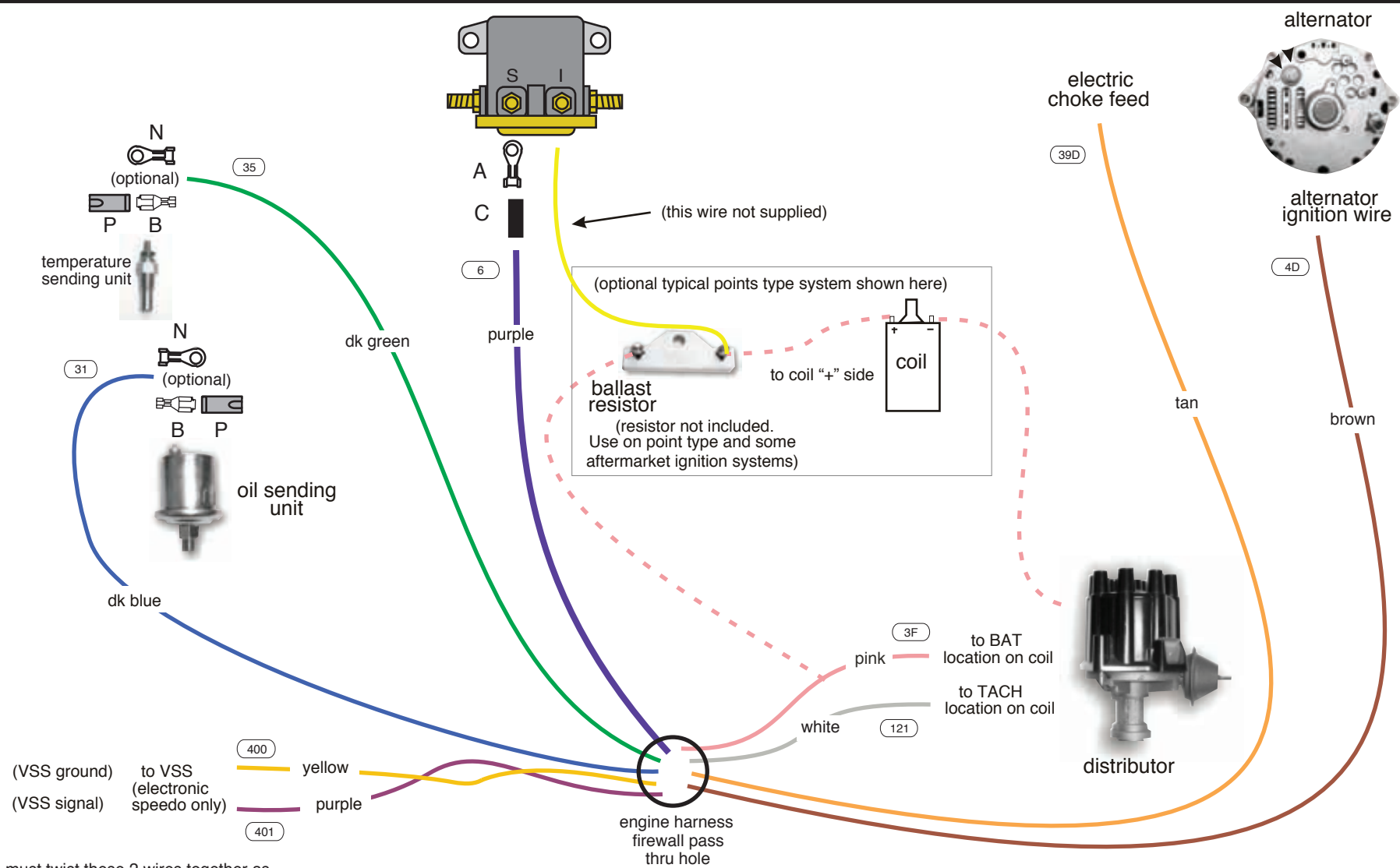

You must twist these 2 wires together as shown above to create a co-ax that will filter out any outside interference to the signal on your electronic speedometer.

Install one grommet included in the 510176 kit into the firewall pass thru opening as shown on page 8 of this instruction set, then pass the engine, alternator ignition, starter sloenoid, and main feed wiring from branch 1 thru this opening (except for the the heat and A/C Feed 50 wire). The neutral safety and B/U lamp wires are optional to run inside or outside the car depending on your application. For starter and main feed connections, refer to "Figure B" on page 10. After completing this task, apply silicone sealer to this area to make a weather tight seal.

Figure "D"

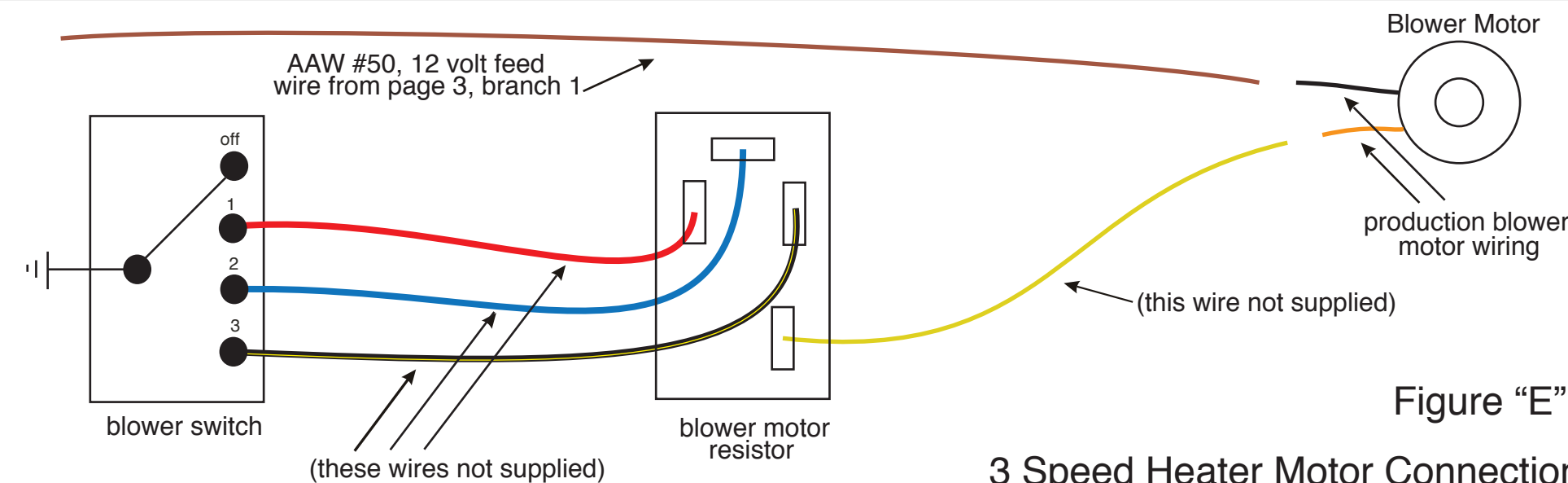

Figure "E"

3 Speed Heater Motor Connections

NOTE: The terminals and connectors listed on this page and denoted with **UPPER CASE LETTERS** to help you complete the various connections to your ignition, temp and oil senders, electric choke, starter solenoid, alternator regulator, etc. can be found in your loose piece grommet and parts kit, P/N 510176.

The identifications, colors, and functions for all of the wires listed in "Figures D, E, and F" on this page can be found on page 3, branch 1 of this main instruction set. AAW suggests and recommends using pages 3, 10, and 11 to complete the installation of the engine and alternator connections.

This AAW kit is engineered to work with most after-market manufacturer's heating and air conditioning systems. As such, we have provided a keyed 12-volt feed to use as the "OFF / ON" (AAW brown 50 wire) power source for whatever system you choose to purchase. The manufacturer will supply you with a harness for their system and instructions on how to connect it. In the event you are utilizing a stock heater system in your car, again we have provided the keyed 12-volt feed only. Figure E below depicts the typical stock 3 speed blower motor resistor and switch connections for the the heating system used in the 1967-68 Mustangs. AAW **DOES NOT** provide any of the other wiring from the switches to the resistors, or to the blower motor.



www.americanautowire.com 856-933-0801

PART # **510055**

DESCRIPTION:

1967-68 Mustang Classic Update Series Kit

92968935 Rev 13.0 7/18/2014

Fuse Placement and Circuit Values

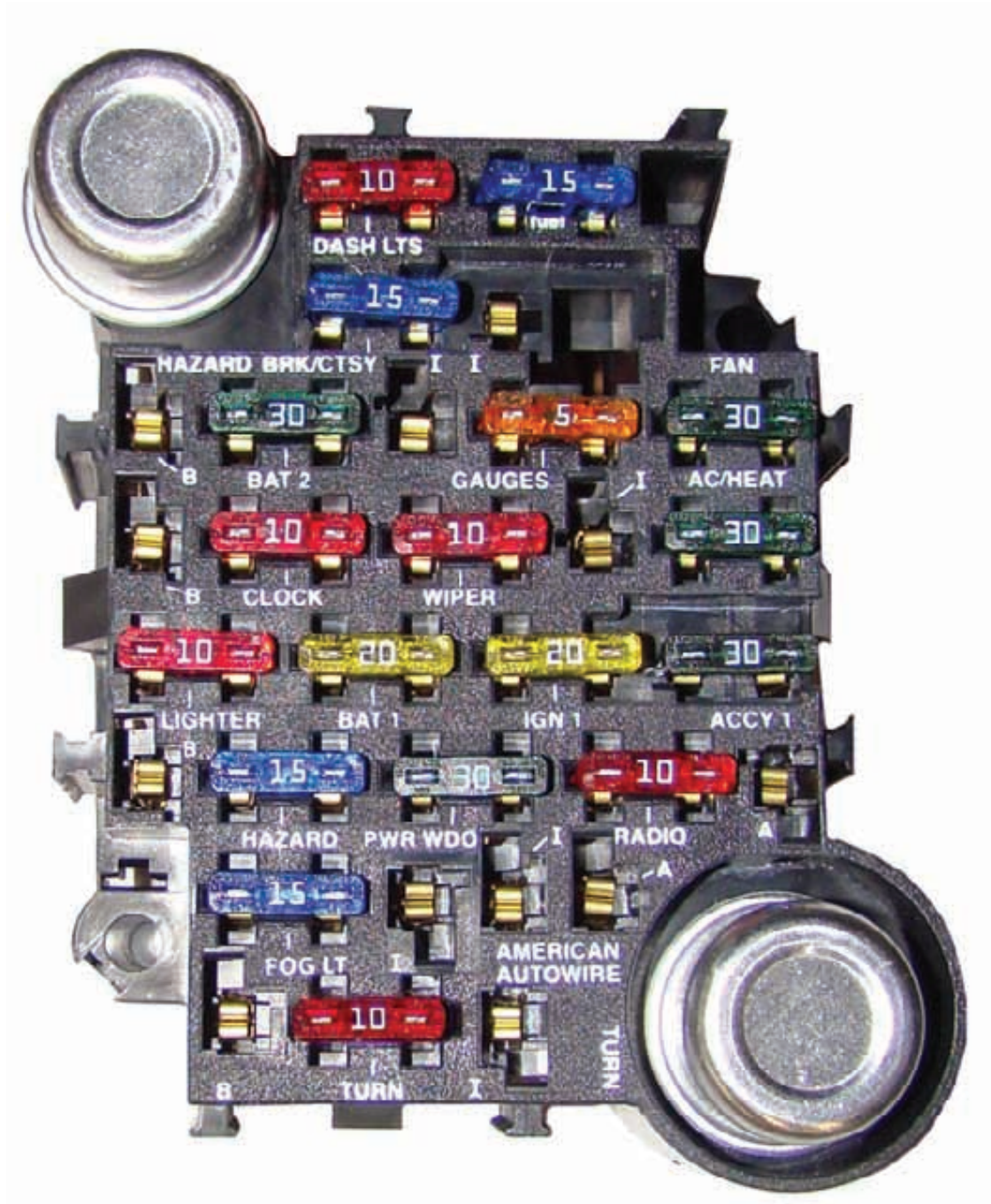

www.americanautowire.com 856-933-0801

PART # **510055**

DESCRIPTION:
**1967-68 Mustang
 Classic Update Series Kit**

92968935 Rev 13.0 7/18/2014