

Classic Update Series

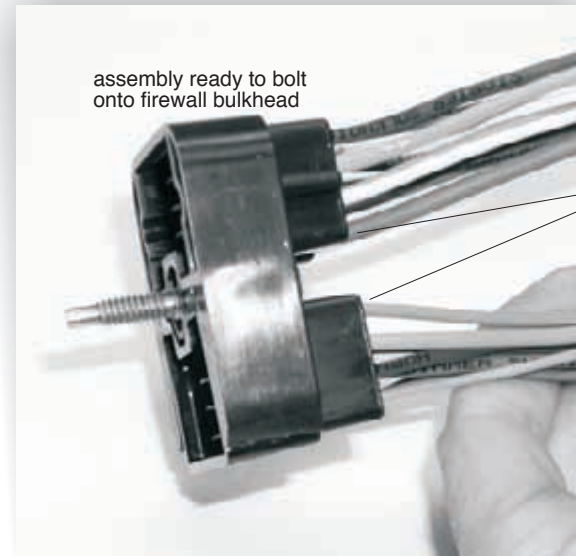

The bulkhead connector from this front light kit must snap into the mating engine connector (bag J), as shown. After snapping together, then bolt the assembly into the dash harness firewall connector using the attached bolt.

Look!

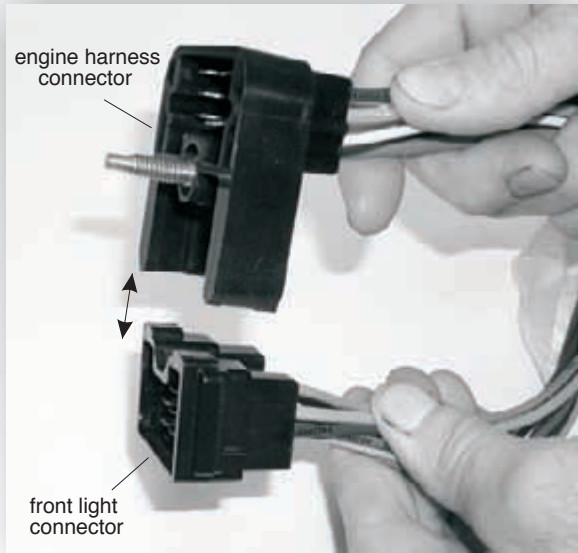

American Autowire

American Autowire
800-482-9473







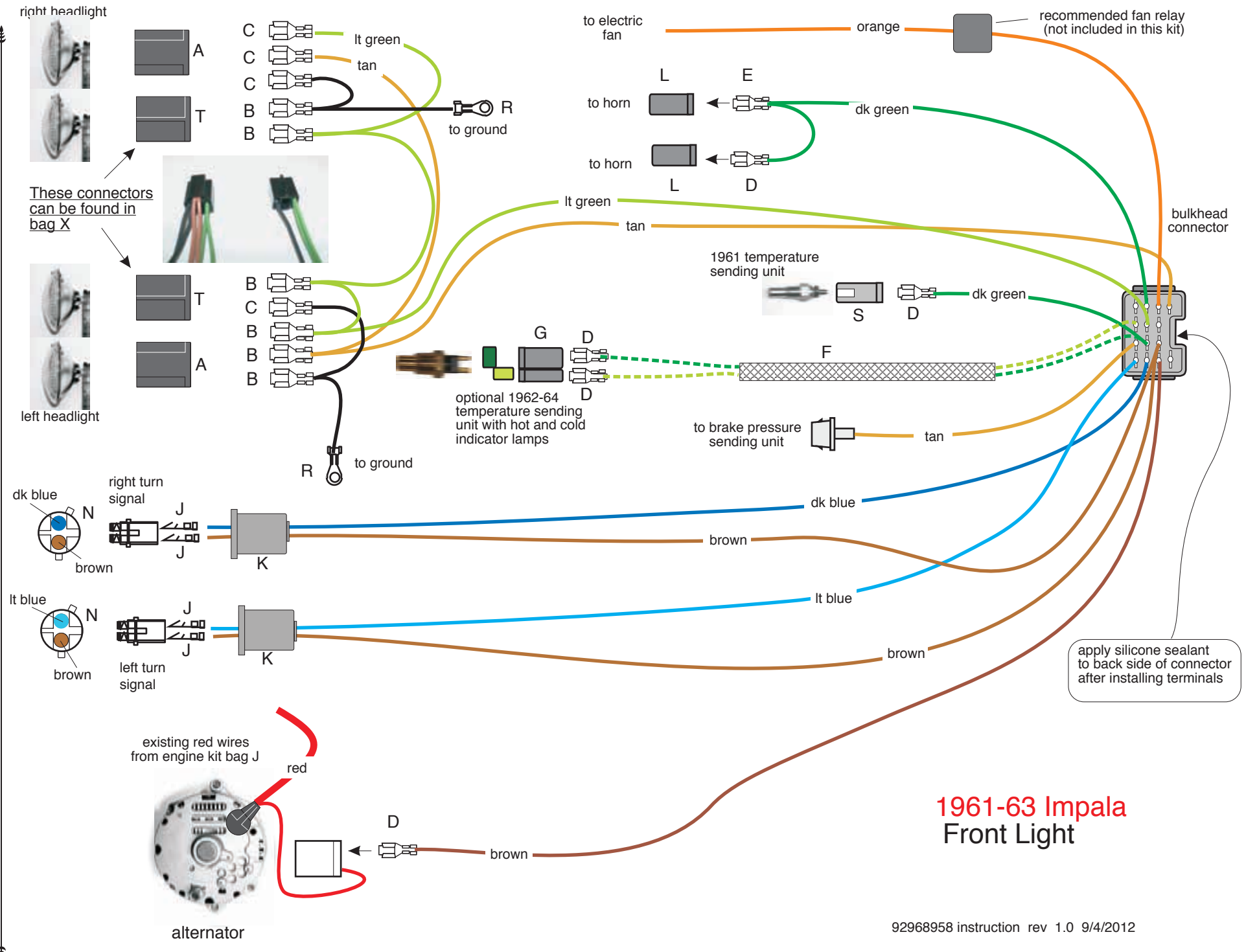





American Autowire also sells factory OEM style harness wrap. this is the same stuff used on original Camaro harnesses! If you want that OEM look with your Classic Update wiring system, then give us a call and order p/n R0067108 !

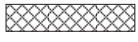

Classic Update Series



1961-1963 IMPALA

A		Connect the bulkhead connector from this kit onto the bulkhead connector from the engine kit (bag J), and bolt to the firewall dash bulkhead. After all wires are installed from this kit, the main connector should have die-electric grease applied to the terminals and silicone sealer applied to the outside of the connectors as a moisture seal.	
B			
C			
D			
E			
F			
G			
J			
K			
L			
N			
R			
S			
T			
		<u>PARKING LAMP WIRES</u>	
		LT BLUE	LH turn
		DK BLUE	RH turn
		BROWN	Parking Lamp
		<u>FRONT LIGHT WIRING</u>	
		TAN (heavy gauge)	Lo Beam
		LT GREEN	Hi Beam
		BLACK	Ground
		<u>OTHER WIRING</u>	
		DK GREEN	Horn
		ORANGE	Electric Fan
		TAN (small gauge)	Brake Sender
		DK GREEN	Water Temp (hot lamp)
		BROWN	Alternator Regulator
		LT GREEN	Water Temp (cold lamp)

Route this wire to the LH turn signal lamp, slide wire through boot K, install terminal J and plug into lamp socket G as shown on sheet 2.

Route this wire to the RH turn signal lamp, slide wire through boot K, install terminal J and plug into lamp socket G as shown on sheet 2.

Route the shorter brown wire that is the same length as the light blue wire to the LH turn signal lamp, slide wire through boot K, install terminal J and plug into lamp socket G as shown on sheet 2. Route the longer brown wire that is the same length as the dark blue wire to the RH turn signal lamp, slide wire through boot K, install terminal J and plug into lamp socket G as shown on sheet 2.

Route this wire to the driver side outer headlight and trim to length. Double this wire with the cutoff portion, and install terminal B. Plug this terminal into connector A, in the location shown on sheet 2. Route the remaining portion of this TAN wire to the passenger side outer headlight and trim to length. Install terminal C and plug into connector A as shown on sheet 2.

Route this wire to the driver side outer headlight and trim to length. Double this wire with the cutoff portion, and install terminal B. Plug this terminal into connector A, make a short jumper over to the driver side inner headlight, cut to length, double it with the cutoff portion, install terminal B, and plug it into connector T in the location shown on sheet 2. Route the remaining portion of this LT GREEN wire to the passenger side inner headlight and trim to length. Double this wire with the cutoff portion, install terminal B and plug into connector T as shown. Make a short jumper over to the passenger side outer headlight, cut to length, double it with the cutoff portion, install terminal C, and plug it into connector A in the location shown on sheet 2.

Route this wire to the driver side outer headlight and trim to length. Double this wire with the cutoff portion, and install terminal B. Plug this terminal into connector A, take the short jumper over to the driver side inner headlight, cut to length, install terminal C, and plug it into connector T in the location shown on sheet 2. Repeat this process for the passenger side.

Route to horns and install terminals D & E, as shown on sheet 2. Plug into connectors L. Route to the electric fan, and connect per manufacturer s instructions
NOTE: We recommend that this wire be used as the trigger wire for the electric fan relay. If your car is equipped with a brake warning system, plug this wire into the main connector as shown on sheet 2 and the other end onto the brake sender switch.

Route through loom F, install terminal D and plug into connector G or S as shown on sheet 2 or install terminal R

Route this wire to the alternator and cut to length. Install terminal D and plug into the regulator connector (previously installed from the engine kit 510066 bag J). (Not used with 1 wire alternator)

Plug this loose wire into the main connector as shown on sheet 2 (62-4 applications). Route the other end through loom F, install terminal D and plug into connector G as shown on sheet 2. This will only be used when using your stock HOT/COLD dash Indicator warning lamp on the 1962-1964 models.

Classic Update Series

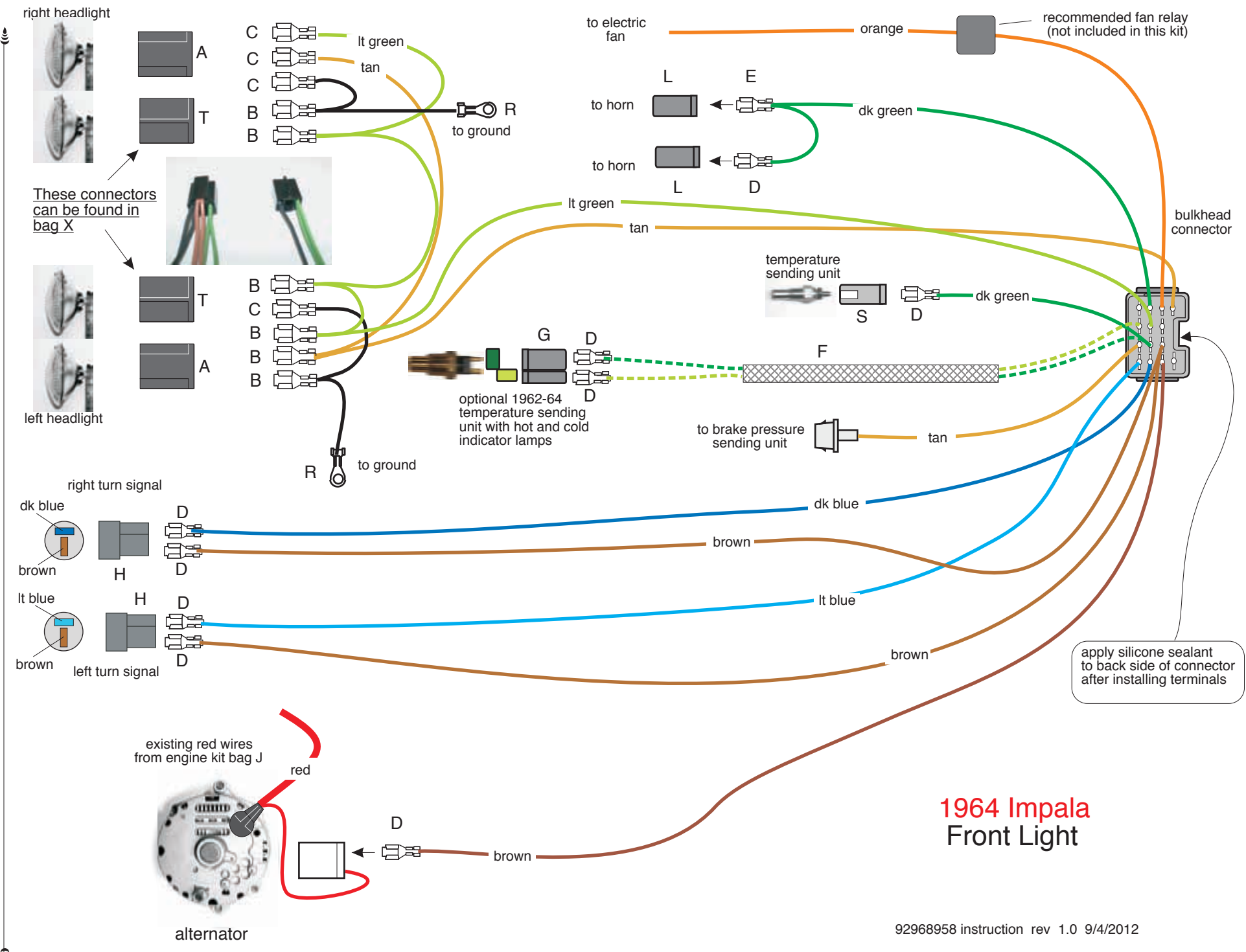

**1964 Impala
Front Light**

92968958 instruction rev 1.0 9/4/2012



A

Connect the bulkhead connector from this kit onto the bulkhead connector from the engine kit (bag J), and bolt to the firewall dash bulkhead. After all wires are installed from this kit, the main connector should have die-electric grease applied to the terminals and silicone sealer applied to the outside of the connectors as a moisture seal.



B

PARKING LAMP WIRES

LT BLUE LH turn

Route this wire to the LH turn signal lamp, install terminal D and plug into connector H as shown on sheet 4.

DK BLUE RH turn

Route this wire to the RH turn signal lamp, install terminal D and plug into connector H as shown on sheet 4.



C

BROWN Parking Lamp

Route the shorter brown wire that is the same length as the light blue wire to the LH turn signal lamp, install terminal D and plug into connector H as shown on sheet 4. Route the longer brown wire that is the same length as the dark blue wire to the RH turn signal lamp, install terminal D and plug into connector H as shown on sheet 4.



D

FRONT LIGHT WIRING

TAN (heavy gauge) Lo Beam

Route this wire to the driver side outer headlight and trim to length. Double this wire with the cutoff portion, and install terminal B. Plug this terminal into connector A, in the location shown on sheet 4. Route the remaining portion of this TAN wire to the passenger side outer headlight and trim to length. Install terminal C and plug into connector A as shown on sheet 4.



E

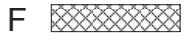

F

LT GREEN Hi Beam

Route this wire to the driver side outer headlight and trim to length. Double this wire with the cutoff portion, and install terminal B. Plug this terminal into connector A, make a short jumper over to the driver side inner headlight, cut to length, double it with the cutoff portion, install terminal B, and plug it into connector T in the location shown on sheet 4. Route the remaining portion of this LT GREEN wire to the passenger side inner headlight and trim to length. Double this wire with the cutoff portion, install terminal B and plug into connector T as shown. Make a short jumper over to the passenger side outer headlight, cut to length, double it with the cutoff portion, install terminal C, and plug it into connector A in the location shown on sheet 4.



G

BLACK Ground

Route this wire to the driver side outer headlight and trim to length. Double this wire with the cutoff portion, and install terminal B. Plug this terminal into connector A, take the short jumper over to the driver side inner headlight, cut to length, install terminal C, and plug it into connector T in the location shown on sheet 4. Repeat this process for the passenger side.



H



L

OTHER WIRING

DK GREEN Horn

Route to horns and install terminals D & E, as shown on sheet 4, Plug into connectors L.

ORANGE Electric Fan

Route to the electric fan, and connect per manufacturer s instructions



R

TAN (small gauge) Brake Sender

NOTE: We recommend that this wire be used as the trigger wire for the electric fan relay. If your car is equipped with a brake warning system, plug this wire into the main connector as shown on sheet 4 and the other end onto the brake sender switch.

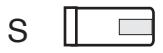

S

DK GREEN Water Temp (hot lamp)

Route through loom F, install terminal D and plug into connector G or S as shown on sheet 4 or install terminal R

BROWN Alternator Regulator

Route this wire to the alternator and cut to length. Install terminal D and plug into the regulator connector (previously installed from the engine kit 510066 bag J). (Not used with 1 wire alternator)



T

LT GREEN Water Temp (cold lamp)

Plug this loose wire into the main connector as shown on sheet 4 (62-4 applications). Route the other end through loom F, install terminal D and plug into connector G as shown on sheet 4. This will only be used when using your stock HOT/COLD dash Indicator warning lamp on the 1962-1964 models.

This page intentionally left blank