

Classic Update Series

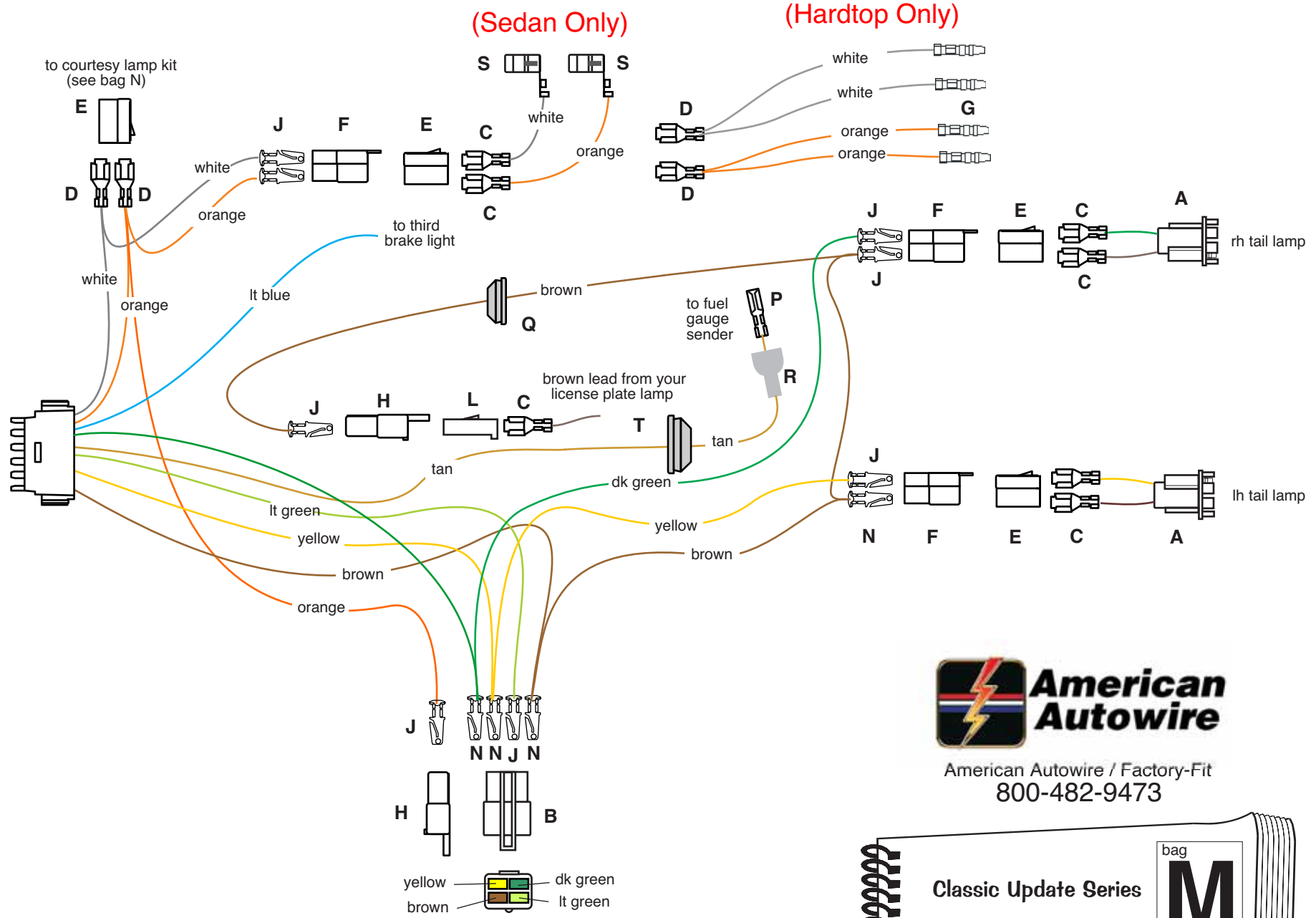

American Autowire / Factory-Fit
800-482-9473

USE THIS SHEET FOR A
61-64 impala

bag

Classic Update Series

M











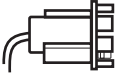

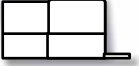

REAR BODY KIT

510069

92968966 instruction rev 0.0 10/9/2008

USE THIS SHEET FOR A 61-64 IMPALA

Connect the main connector to the mating connector on the dash harness 500957 bag G. Route this harness along door sill and into trunk

A		LIGHT BLUE TAN	Third brake light Fuel Tank lead (with rubber end)	Connect to the third brake lamp, if equipped. Route wires to the rear of the car, measure to proper length going thru access hole in trunk floor and to the sending unit, cut to length. Slide grommet Q onto wire in the direction shown on sheet 1, slide boot R onto wire, strip back end and crimp terminal P onto wire. Once terminal P is secured to wire, pull boot R down over terminal P and install onto sending unit.
B		BROWN	Parking lamps	Route this wire to the left side tail light and trim to length. Double this wire with the cut off portion and install terminal N and plug into connector F. Route the loose end to the LH license plate lamp. Cut to length, and double this wire with the cut off portion, using terminal N and plug into connector H. Route the loose end to the right side license plate lamp, trim to length, install terminal N and plug into connector H.
C				
D		YELLOW	LH Stop / Tail	Route the loose end to the RH tail light, trim to length, install terminal J and plug into connector F. Route this wire to the LH tail lamp and cut to length and install terminal J. Plug this wire into connector F from above. Install terminal C and connector E on the tail lamp pigtail A, maintaining color continuity with connector F. Plug connector E into connector F.
E		DK GREEN	RH Stop / Tail	Route this wire to the RH tail lamp and cut to length and install terminal J. Plug this wire into connector F from above. Install terminal C and connector E on the tail lamp pigtail A, maintaining color continuity with connector F. Plug connector E into connector F.
F		LIGHT GREEN	Back up lamp feed	Route this wire to the LH back up lamp and trim to length and install terminal N and connector H. Route the loose end of the lt green wire to the right side back up lamp. Repeat this procedure with terminal J. Install terminals C on each of the back up pigtails B, and plug into connectors H.
G				NOTE: In the case of a 1965 Chevelle, the back up light assemblies utilize a smaller connector than we have supplied with this kit. For that reason, we have supplied a mating connector for you to install into your original assemblies.
H		WHITE	Courtesy ground	At the driver's side kick panel area, cut this wire and double it with the cut off portion using terminal D, and plug into connector E maintaining color continuity with the mating connector in the courtesy lamp kit (bag N). If you are using a dome lamp, route the loose end of this wire to the rear pillar area of the trunk, and install terminal J and connector F. Plug into connector F in location shown on sheet 1. (Note: a factory dome lamp harness will also plug into this connector, if you are not replacing the headliner at this time.) Install the loose white wire S (supplied with terminal installed) into the dome lamp. Route this wire to connector F (on white wire) location and trim to length. Install terminal C and connector E, maintaining color continuity with the white wire in connector F.
J				
L				
N		ORANGE	Courtesy Lamp	At the driver's side kick panel area, cut this wire and double it with the cut off portion using terminal D, and plug into connector E maintaining color continuity with the mating connector in the courtesy lamp kit (bag N). If you are using a dome lamp, route the loose end of this wire to the rear pillar area of the trunk, and install terminal J and connector F. Plug into connector F in location shown on sheet 1. (Note: a factory dome lamp harness will also plug into this connector, if you are not replacing the headliner at this time.) Install the loose orange wire S (supplied with terminal installed) into the dome lamp. Route this wire to connector F (on orange wire) location and trim to length. Install terminal C and connector E, maintaining color continuity with the orange wire in connector F.
P				
Q				
R				
S				
T	