

**INSTALLING THE FUSE BOX**

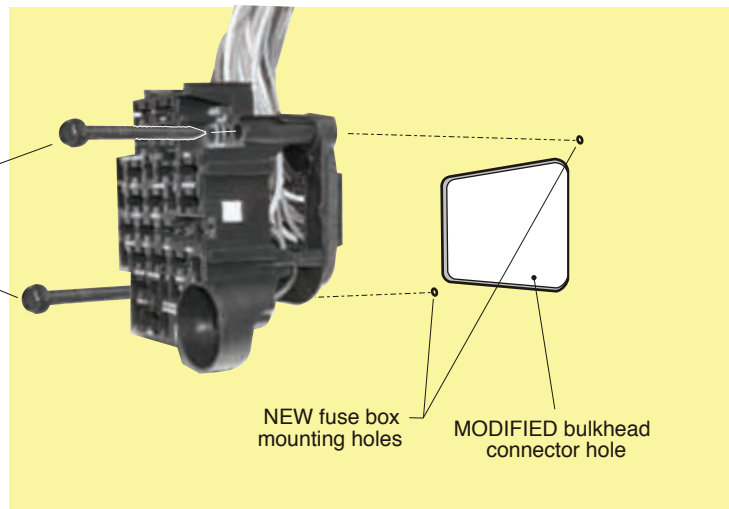

**Fuse Panel Installation Instructions**

Following these simple instructions will guarantee a successful installation of your American Autowire fuse panel harness.

1. Study the diagram above to familiarize yourself with the dash harness.
2. Modify your firewall opening and install the fuse box (see item #1 below left, and 92968980 template).
3. Route the dash harness using the factory support straps.
4. Make all connections as shown on the following pages of this dash harness kit.
5. Once this harness is installed, continue to bag 'H', and install the rest of the kit (bags H,J,K,L,M).



1. Locate the stock OEM bulkhead hole in the driver side of the firewall. **NOTE: You will need to modify the opening in the firewall by making it larger. See firewall template 92968980 to help with this operation.**
2. Mount the fuse box with the flasher can in the bottom right corner, as shown above.
3. Using the two mounting screws A, attach the fuse panel to the firewall.



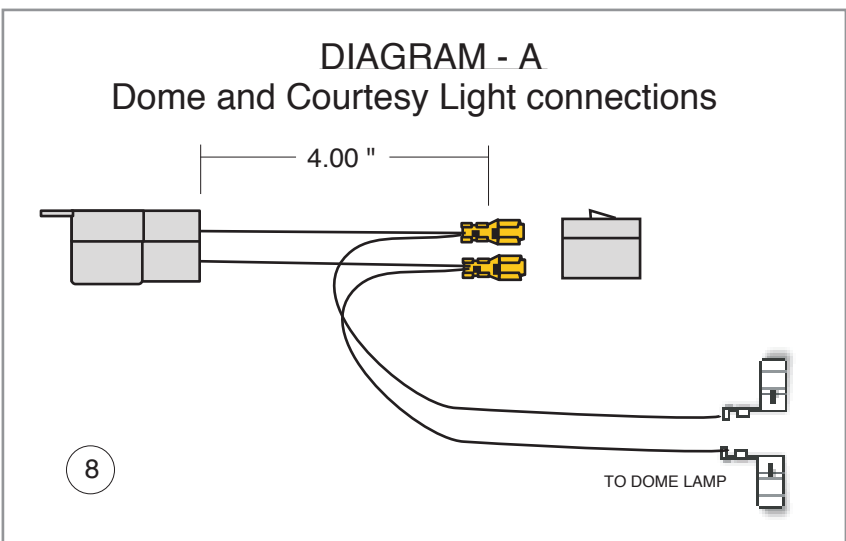
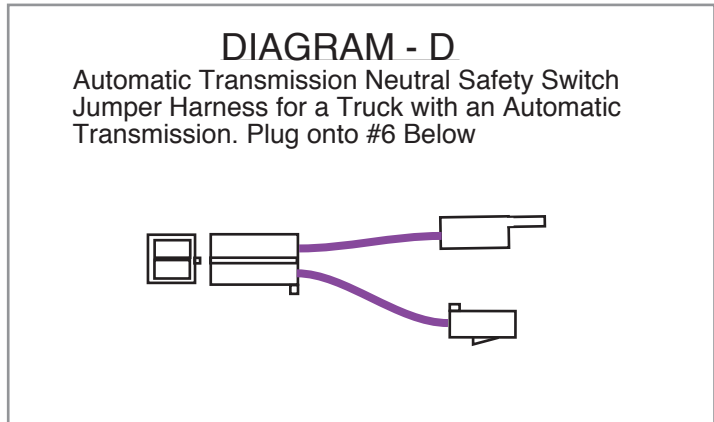
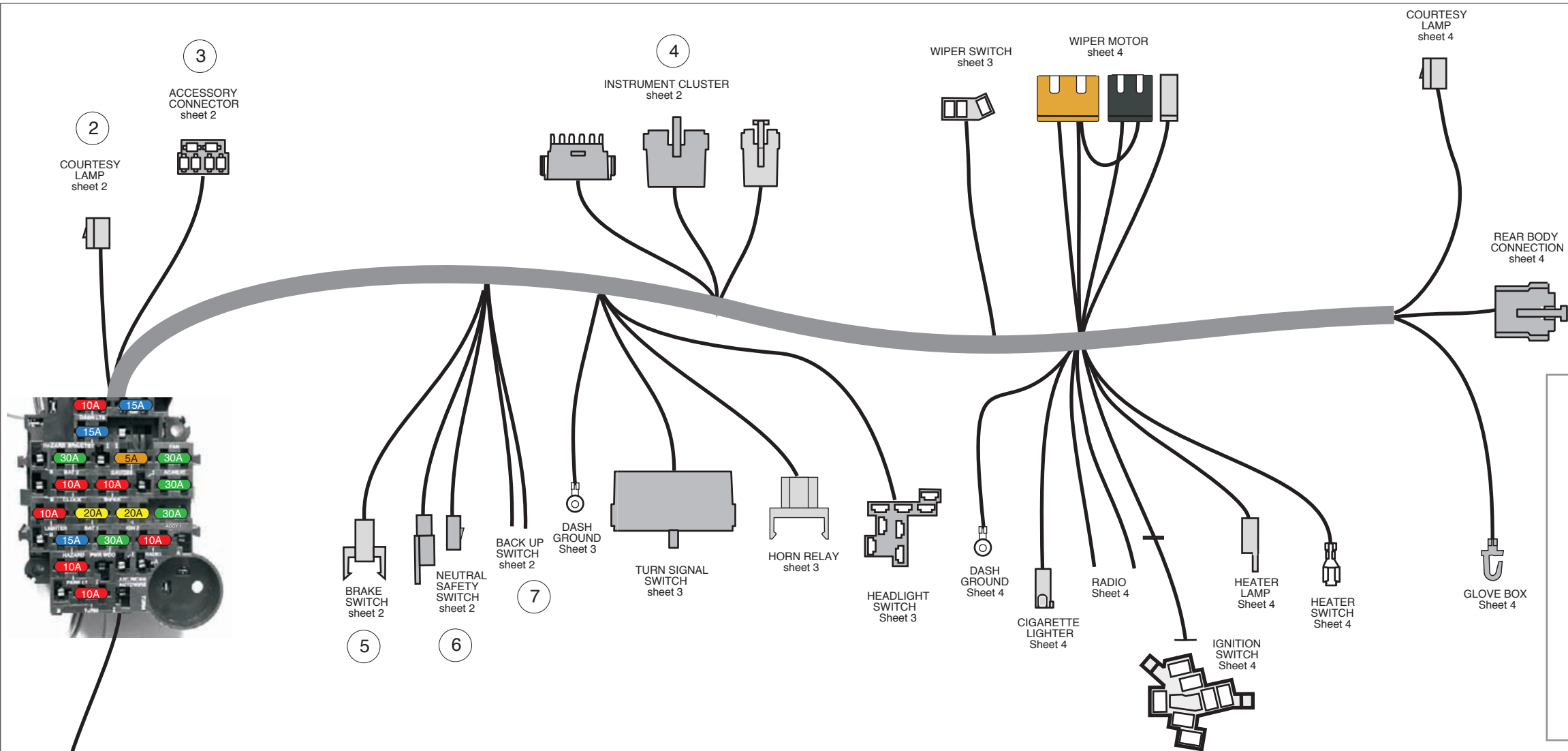

www.americanautowire.com 856-933-0801





1. **FLOOR DIMMER SWITCH**  
 Plug this connector into the floor dimmer switch (part # 510104).  
 Yellow Dimmer feed to DIMMER FEED location on headlight switch.  
 Light Green Headlight High Beam Feed 'HEADLIGHT - HIGH BEAM' from dimmer switch through the bulkhead connector to the front headlight connector high beam location.  
 Tan Headlight High Low Feed 'HEADLIGHT - LOW BEAM' from dimmer switch through the bulkhead connector to the front headlight connector low beam location.
2. **LH COURTESY LAMP**  
 Plug this connector into the mating connector from the courtesy lamp kit bag N, 500708.  
 Orange 12 volt battery feed for lamp  
 White Ground circuit for lamp
3. **ACCESSORIES**  
 Use the provided connector J attached and terminals as power leads for the following:
 

	Fuse	Rating	
Dark Blue	FUEL	15 amp	Fused 12 volt IGNITION feed for fuel pump (may also be used to feed power to another ignition circuit)
Orange	BAT1	20 amp	Fused 12 volt BATTERY feed for power seats (may also be used to feed power to another battery circuit)
Red	BAT2	30 amp	Fused 12 volt BATTERY feed for power door locks (may also be used to feed power to another accessory circuit)
Pink	IGN1	20 amp	Fused 12 volt IGNITION feed for cruise control (may also be used to feed power to another ignition circuit)
Yellow	PWRWDO	30 amp	Fused 12 volt IGNITION feed for power windows (may also be used to feed power to another ignition circuit)
Tan	ACCY1	30 amp	Fused 12 volt ACCESSORY feed (may also be used to feed power to an accessory circuit)
4. **INSTRUMENT CLUSTER DISCONNECTS**  
 These connectors will plug into the gauge disconnect harness from bag H. Wire identifications are described on the instruction sheets from bag H.
5. **BRAKE SWITCH**  
 Plug this connector into the factory brake switch.  
 Orange 12 volt feed 'in' to switch.  
 White 12 volt feed 'out' to steering column switch.  
 Lt Blue 12 volt feed 'out' to third brake light.
6. **NEUTRAL SAFETY SWITCH**  
 If using an automatic transmission, plug these wires into the NSS jumper harness in Diagram D, then plug onto the neutral safety switch on the column, or plug together if using a manual transmission.  
 Purple 12 volt feed 'in' to neutral safety switch.  
 Purple 12 volt feed 'out' to starter
7. **BACK UP SWITCH**  
 Connect these wires to the back up switch on the column, console shifter, or transmission.  
 Pink 12 volt ignition feed 'in' to back up lamp switch  
 Lt Green 12 volt feed 'out' to back up lamps
8. **DOMELAMP**  
 a. If no under dash courtesy lamps are desired, plug dome lamp harness in at location #2, and route the other end to the dome lamp assembly.  
 b. If under dash courtesy lamps are desired, cut the enclosed dome lamp harness 4" from the main connector, double with the cutoff portion using the enclosed terminals, and plug into the provided connector as shown in Diagram "A". Install the completed dome lamp harness onto dash harness at location #2, then plug in the under dash courtesy lamp from bag N, 500708 to the pigtail on this dome lamp connection. (see Diagram "A" for this application)  
 Orange 12 volt battery feed for lamp  
 White Ground circuit for lamp



www.americanautowire.com 856-933-0801



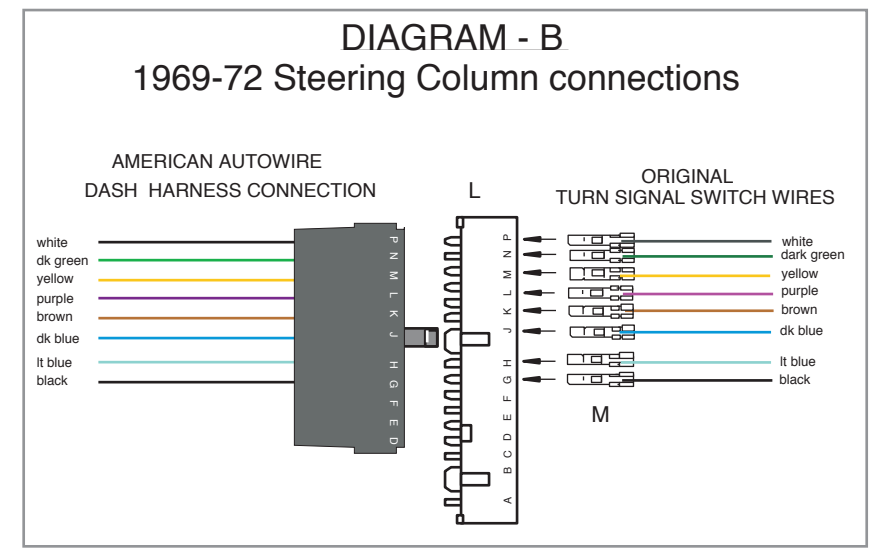
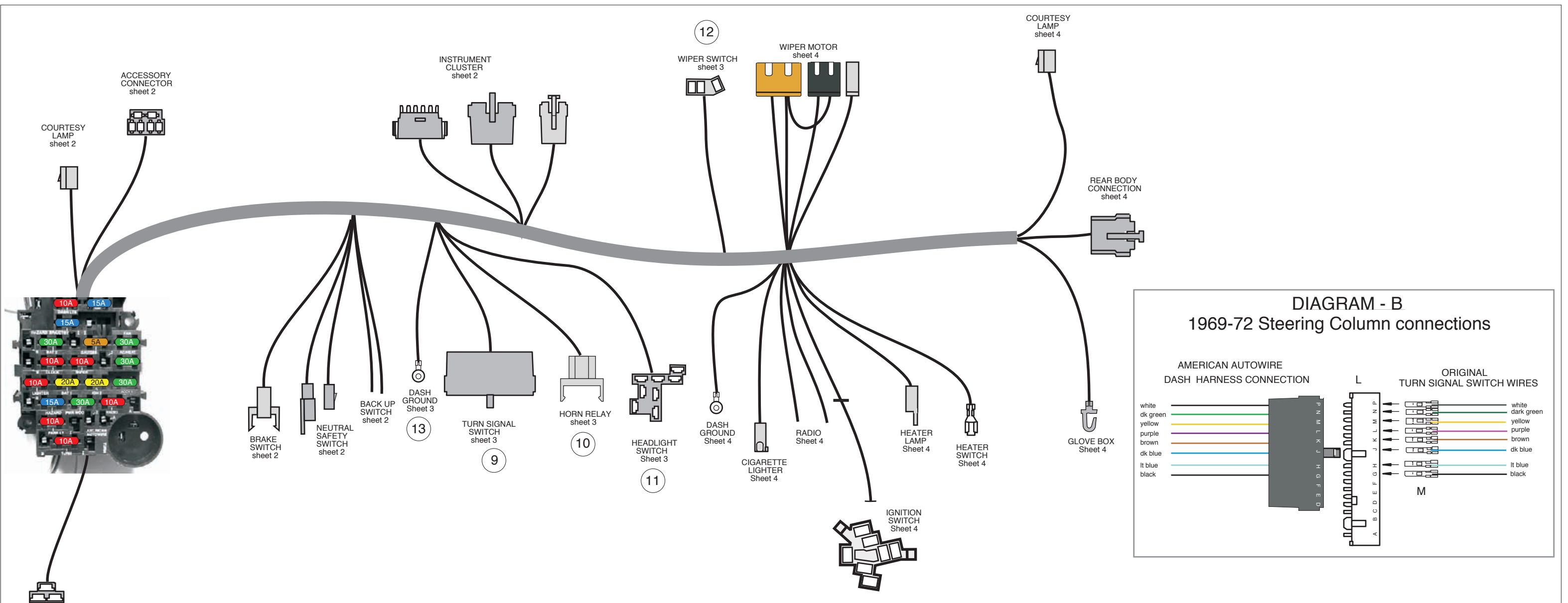

9. TURN SIGNAL SWITCH This harness is set up for a 1969-74 GM or Steering column utilizing a 3 7/8 turn signal switch connector. If you are using your truck's original column, we have included the proper connector (L) and terminals (M) for you to cut off your existing connector and adapt it into our new dash harness. If using a 1975 or later GM steering column or an after-market steering column using a GM turn signal switch with the 4-1/4 GM turn signal connector, it will be necessary to replace the 4 1/4 turn signal switch connector with the included 3 7/8 connector L, matching wires by color. (see Diagram "B" for this application)

- White 12 volt feed from brake switch
- Dark Green RH tail lamp
- Yellow LH tail lamp
- Purple 12 volt feed from turn flasher
- Brown 12 volt feed from hazard flasher
- Dark Blue RH front park lamp
- Light Blue LH front park lamp
- Black Horn relay ground wire to horn switch

10. HORN RELAY Plug the horn relay (found in the fuse bag) into this connector.  
 Red 12 volt battery  
 Black Relay ground circuit (to steering column)  
 Green Triggered 12 volts to horn

11. HEADLIGHT SWITCH  
 Red 12 volt feed to switch 'BAT' location on headlight switch  
 Orange 12 volt feed in to park/tail PARK / TAIL FEED IN location on headlight switch. (commonly found on GM headlight switches)  
 Brown Park lamp feed out PARK LAMP OUT location on headlight switch.  
 Yellow Dimmer feed DIMMER FEED location on headlight switch.  
 Dk Green Instrument lamp feed INSTRUMENT LAMP location on headlight switch.  
 White Dome / courtesy ground GROUND location on headlight switch.

12. WIPER SWITCH Plug this connector into the stock wiper switch.  
 Black Low speed ground  
 Light Blue High speed ground  
 Dark Blue Washer pump ground









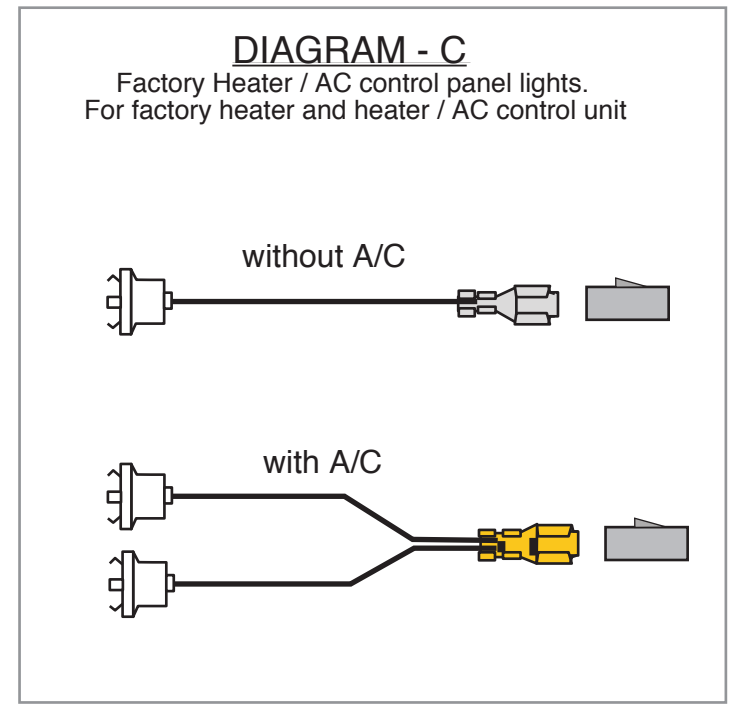
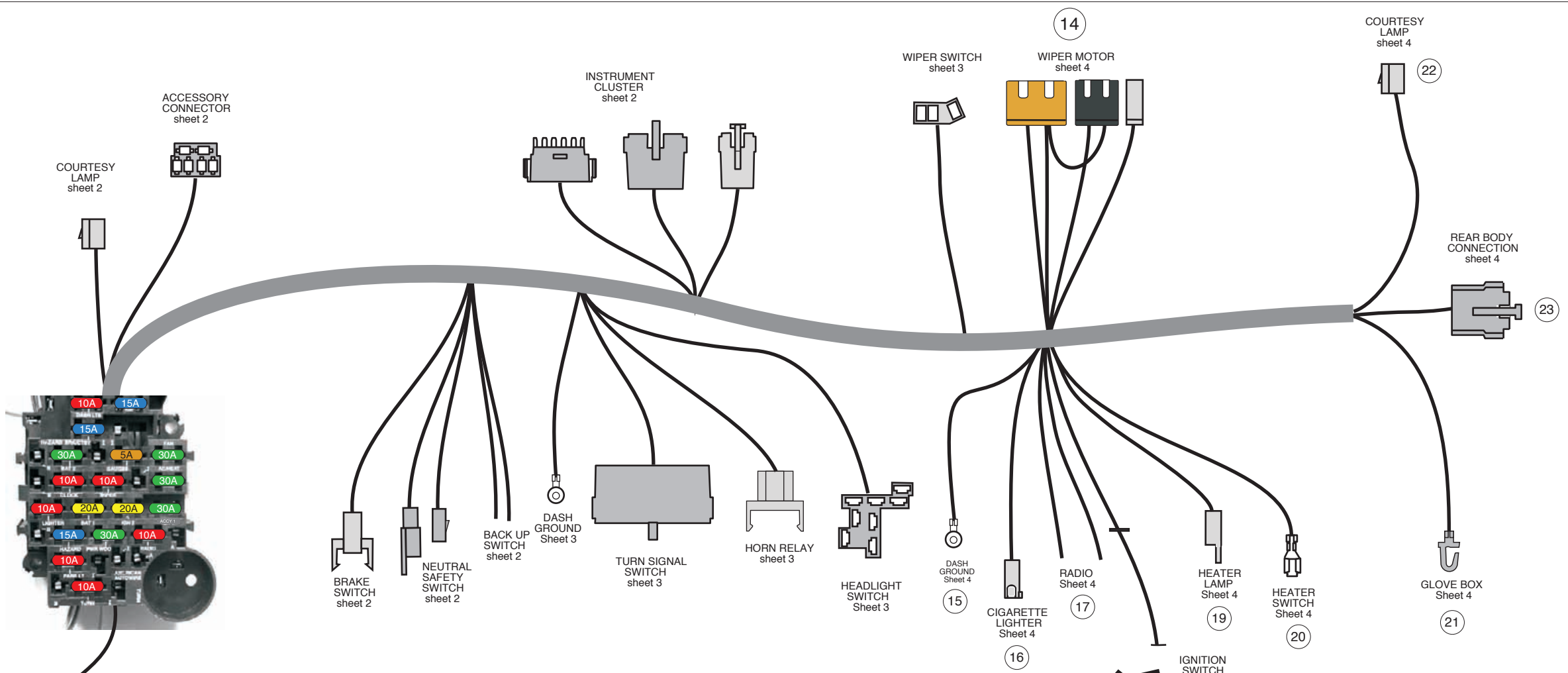

13. GROUND Black Connect to a good chassis ground



www.americanautowire.com 856-933-0801





- 14. WIPER MOTOR  
 Plug these connectors into the stock wiper motor. The connectors are indexed and can only be plugged in one way.  
 White 12 volt ignition  
 Black Low Speed Ground  
 Light Blue High Speed Ground  
 Dark Blue Washer Pump Ground
- 15. GROUND  
 Black Connect to a good chassis ground.
- 16. CIGARETTE LIGHTER  
 Orange Connect to lighter. (battery feed)
- 17. RADIO  
 Tan Radio accessory feed. (On-Off switch)  
 Yellow Radio 12 volt clock lead (battery feed)
- 18. IGNITION SWITCH  
 Red 12 volt battery feed  
 Pink 12 volt ignition feed  
 Brown 12 volt accessory feed  
 Purple 12 volt starter feed
- 19. HEATER LAMP  
 AAW has provided 2 dash lamp pigtail wires for final connection to you heater or A/C control unit. If your truck has a heater only, use the single wire terminal (silver), install onto 1 pigtail, plug into the provided connector, and install onto the dash harness at location #18. If your truck has factory air, use the double wire terminal (brass), double onto both pigtail wires, plug into the provided connector, and install onto the dash harness at location #18.  
 Gray Heater lamp (see Diagram "C" for your application)
- 20. HEATER SWITCH  
 AAW has provided the heater or A/C feed wire only for this application to be used in conjunction with your OE factory heater or A/C harness. If you desire a new heater or A/C harness for your truck, contact AAW for the exact application for your truck. (The orange A/C high speed blower power feed from your OE A/C harness can be plugged into the accessory plug #3 shown on sheet 2 by removing the black connector from the wire and installing the bare terminal into the mating cavity of the RED wire at that accessory plug).  
 Brown 12 volt accessory feed to heater / ac switch. (if using aftermarket a/c, use this brown wire as the keyed accessory feed wire to a/c harness.)
- 21. GLOVE BOX LIGHT  
 Orange Connect to the original factory glove box lamp switch. If not using, just insulate the bare terminal and tape back.
- 22. RH COURTESY LAMP  
 Plug this connector into the mating connector from the courtesy lamp kit bag N, 500708.  
 Orange 12 volt battery feed for lamp  
 White Ground circuit for lamp
- 23. REAR BODY  
 This connector will mate to the connector from the Rear Body harness found in bag M.  
 Tan Fuel tank sender lead  
 Brown Tail lamp feed  
 Yellow LH turn / brake feed  
 Dark Green RH turn / brake feed  
 Light Green Back up lamp feed  
 Light Blue Third brake light



www.americanautowire.com 856-933-0801

