

On the following pages, you will find many detailed, specialized instructions that will help you install the dash, cluster, front light, and rear body harnesses from our '70-73 Camaro Classic Update Kit into your '70-73 Pontiac Firebird. These instructions along with the specialized harnesses and parts from our 510229 Cluster and Lighting Extension kit will need to be used in conjunction with the corresponding instructions and parts from the 510033 dash, 510044 cluster, 500671 front light, and 510042 rear body kits. These modifications include specialized front parking lamp connections, specialized rear body tail lamp and backup lamp connections, as well as specialized dash cluster connections.

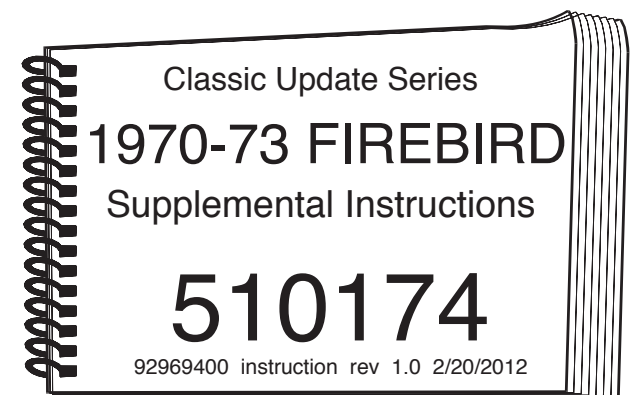

**American
Autowire**

800-482-9473



Classic Update Series

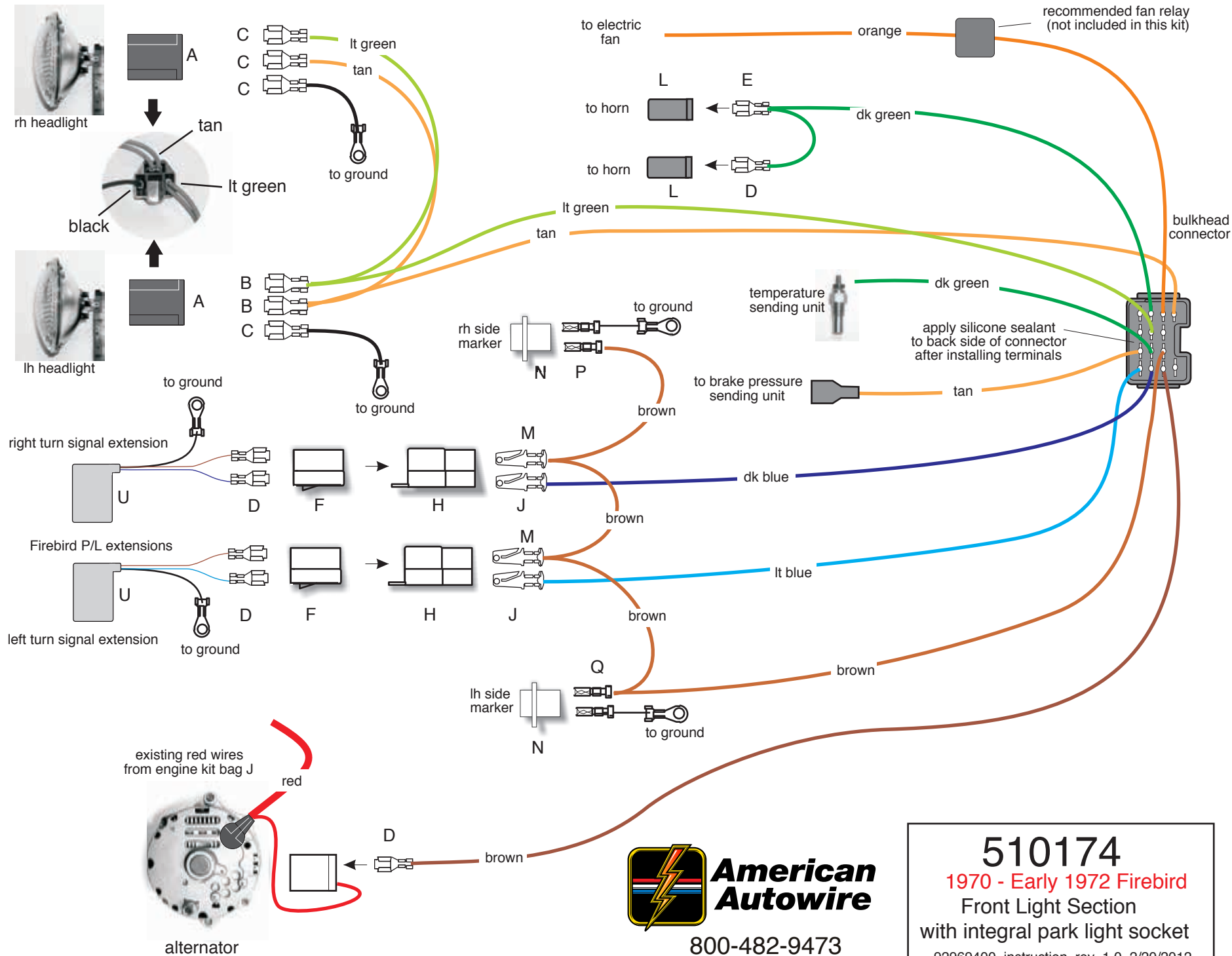

510174

1970 - Early 1972 Firebird
Front Light Section
with integral park light socket

92969400 instruction rev 1.0 2/20/2012



800-482-9473

Classic Update Series

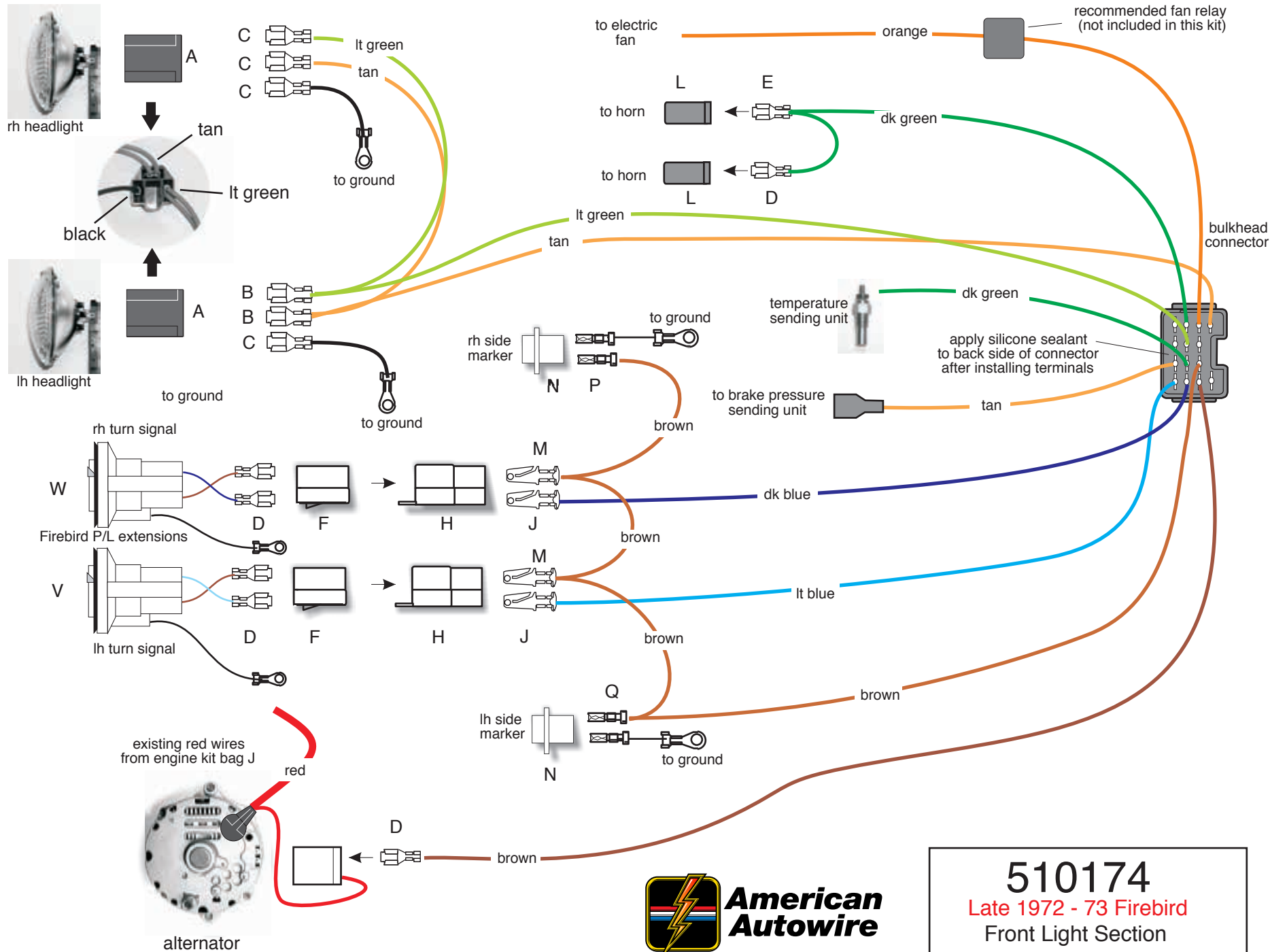

**American
Autowire**

800-482-9473

510174

Late 1972 - 73 Firebird

Front Light Section

with separate park light socket

92969400 instruction rev 1.0 2/20/2012

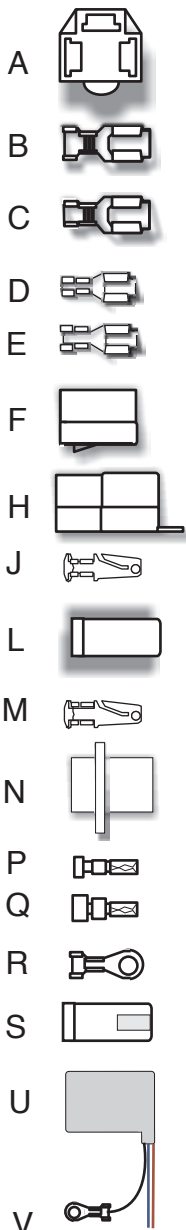

1970-73 Firebird Front Lighting

Connect the bulkhead connector from this kit onto the bulkhead connector from the engine kit (bag J), and bolt to the firewall dash bulkhead.

PARKING LAMP WIRES

C	LT BLUE	LH turn
D	DK BLUE	RH turn
E	BROWN	Parking Lamp

Route this wire to the LH turn signal lamp and install terminal J and plug into connector H, as shown on sheet 2.

Route this wire to the RH turn signal lamp and install terminal J and plug into connector H as shown on sheet 2.

Route this wire to the LH side marker lamp and cut to length. Double this wire with the cut off portion, and install terminal Q. Plug into connector N. Also plug the pre-assembled black ground wire into connector N, as shown on sheet 6. Route the remaining portion of the brown wire to the LH turn signal lamp, and cut to length. Double this wire with the cut off portion and install terminal M and plug into connector H, along with the LT Blue wire from above. Route the remaining portion of the brown wire to the RH turn signal lamp, and cut to length. Double this wire with the cut off portion and install terminal M. Plug this terminal into connector H, along with the DK Blue wire above. Route the remaining brown wire to the RH side marker and trim to length. Install terminal P and plug into connector N. Also plug the pre-assembled black ground wire into connector N, as shown on sheet 6.

NOTE: For 1970 - early 1972 cars see sheet 2. The running and directional light assemblies used a socket and connector assembly that was integral to the lamp itself. These cars used a rubber molded connection on the forward lamp harness that pushed onto that socket and connector assembly. Connector and wire pigtails U have been provided for you to make these connections. Take note that there are 2 different color pigtails U included, one with a dk. blue wire in it (RH), and one with a black with lt. blue stripe wire in it (LH). Install terminals D onto these pigtails, plug them into connector F maintaining color continuity with the main parking lamp connections from above, then plug connector F into connector H. Attaching the ring terminals that have been installed onto the black wires of these lamp socket assemblies to a good chassis ground will complete the parking and turn signal circuits. **For late 1972 & 73 cars see sheet 3.** The running and directional light assemblies used a housing that had a separate twist in lamp socket that was part of forward lamp harness assembly. Lamp socket assemblies V (driver side) and W (passenger side) have been provided for you to make these connections. Install terminals D onto these lamp socket assemblies, plug them into connector F maintaining color continuity with the main parking lamp connections from above, then plug connector F into connector H. Attaching the ring terminals that have been installed onto the black wires of these lamp socket assemblies to a good chassis ground will complete the parking and turn signal circuits.

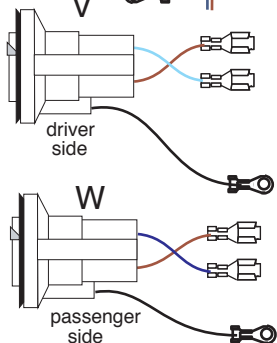

**American
Autowire**

800-482-9473

510174

**1970 - 73 Firebird
Front Light Section**

92969400 instruction rev 1.0 2/20/2012

1970-73 Firebird Front Lighting

FRONT LIGHT WIRING

TAN (heavy gauge)	Lo Beam	Route this wire to the driver side headlight and trim to length. Double this wire with the cutoff portion, install terminal B, and plug into connector A in the location shown on sheet 2 or 3. Route the remaining portion of this TAN wire to the passenger side headlight and trim to length, install terminal C, and plug into connector A in the location shown on sheet 2 or 3.
LT GREEN	Hi Beam	Route this wire to the driver side headlight and trim to length. Double this wire with the cutoff portion, install terminal B, and plug into connector A in the location shown on sheet 2 or 3. Route the remaining portion of this LT GREEN wire to the passenger side headlight and trim to length, install terminal C, and plug into connector A in the location shown on sheet 2 or 3.
BLACK	Ground	Install terminal C and plug into connector A at the driver side headlamp as shown on sheet 2 or 3. Repeat this process for the passenger side headlamp assembly.
DK GREEN	Horn	Route this wire to the horns, cut to length, double it with the cutoff portion, install terminal E, and plug into connector L as shown on sheet 2 or 3. Route the remaining portion to the second horn, cut to length, install terminal D, and plug into connector L as shown on sheet 2 or 3.
ORANGE	Electric Fan	Route to the electric fan, and connect per manufacturer's instructions. NOTE: We recommend that this wire be used as the trigger wire for the electric fan relay.
TAN (small gauge)	Brake Sender	Plug this wire onto the stock brake sender switch.
DK GREEN	Water Temp	Connect this wire to the temperature sending unit using terminal R, or terminal D and connector S (depending on your sending unit).
BROWN	Alternator Regulator	Route this wire to the alternator and cut to length. Install terminal D and plug into the off white regulator connector as shown on sheet 2 or 3. (Connector previously installed from the engine kit, P/N 500668 bag J). NOTE: This wire is only used on an alternator with an internal regulator which uses an exciter wire. If you are using a true one wire alternator, then this BROWN wire can be removed and not used.

After all wires are installed from this kit, the main connector should have die-electric grease applied to the terminals. Also, to assure a moisture resistance seal, apply silicone sealant to the outside of the main connector around each wire.



**American
Autowire**

800-482-9473

510174

1970 - 73 Firebird

Front Light Section

92969400 instruction rev 1.0 2/20/2012

Classic Update Series

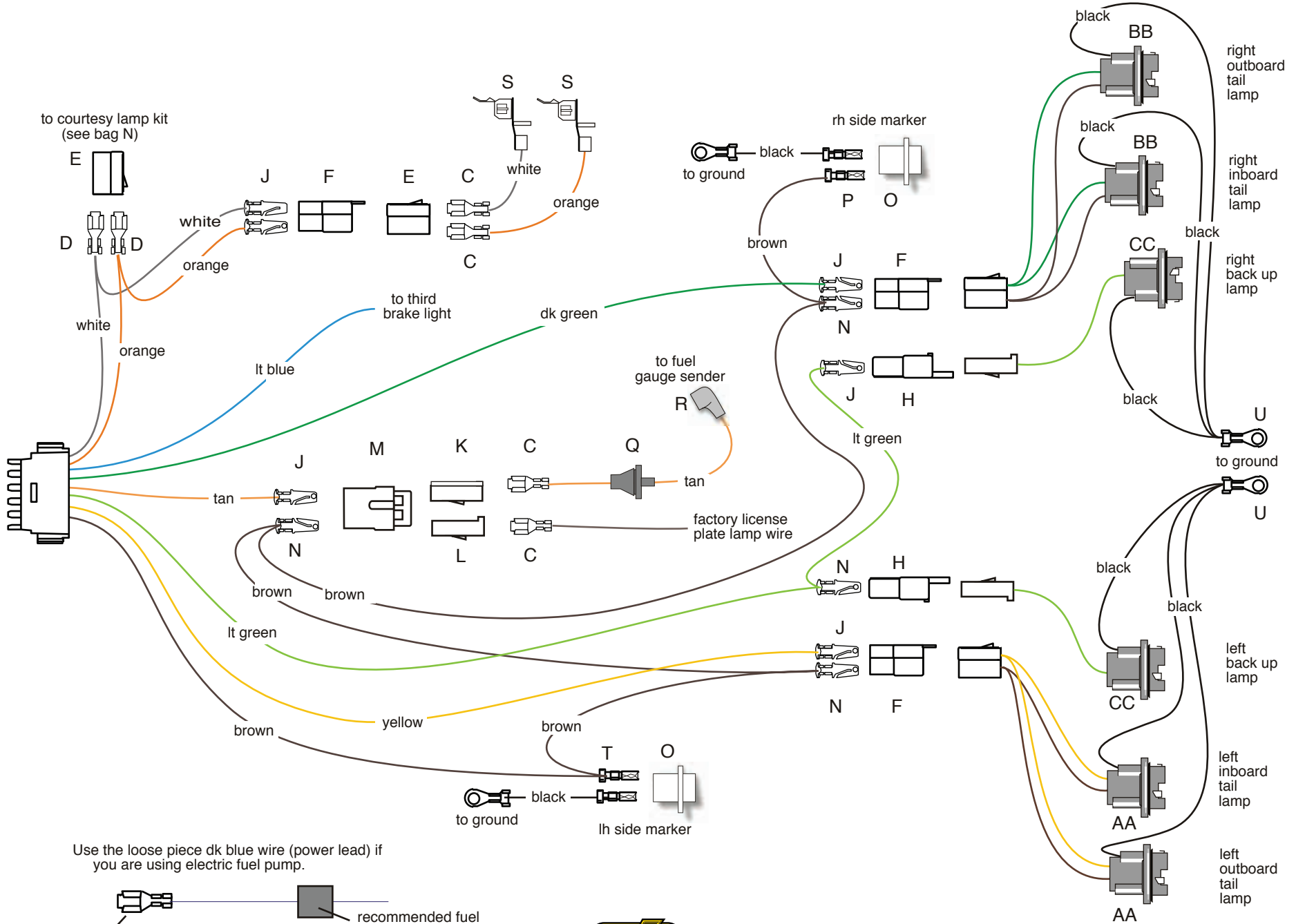









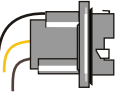
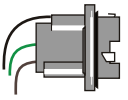
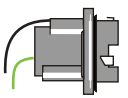

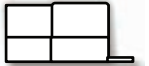
**American
Autowire**

800-482-9473

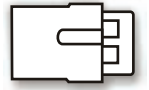
510174
1970 - 73 Firebird
Rear Body Section
 92969400 instruction rev 1.0 2/20/2012

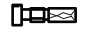
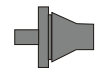
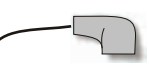
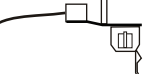
1970 - 73 Firebirds Rear Body

<p>Connect the main connector to the mating connector on the dash harness 510033 bag G. Route this harness along door sill and into trunk.</p>				
AA		LIGHT BLUE TAN	Third brake light Fuel signal	Connect to the third brake lamp, if equipped. Route this wire to the rear panel of the trunk (near fuel tank filler) and trim to length. Install terminal J and plug into connector M, as shown on sheet 6.
BB		TAN	Fuel tank lead	Plug the rubber end of this wire R onto the sending unit on fuel tank. Route the wire (with rubber end) to the stock feed thru hole under fuel tank filler and install rubber grommet Q in direction shown on sheet 6. Secure this wire into hole with the attached grommet. In the trunk area, trim this wire to reach connector M from wire above. Attach terminal C and plug into connector K. Plug connector K into mating connector M. This should match the tan wire from above.
CC				
C				
D				
F		BROWN	Parking lamps	Route this wire to the left side marker and trim to length. Double this wire with the cut off portion, install terminal T, and plug into lamp socket O. Route the loose end to the LH tail lamp, cut to length, double this wire with the cut off portion using terminal N and plug it into connector F in location shown on Sheet 6. Route the loose end to connector M (from the tan wire above), cut to length, double this wire with the cut off portion, install terminal N, and plug it into connector M in location shown on sheet 6. Route the loose end to the RH tail lamp, cut to length, double this wire with the cut off portion using terminal N and plug into connector F, in location shown on Sheet 6. Route the remaining portion of this wire to the RH side marker, install terminal P, and plug into lamp socket O.
H				
J				
K		BROWN	License Lead	Your existing license plate lamp wire will plug into connector M. (Note: Terminal C and connector L have provided for you to make this connection.)
L		BLACK	Side marker ground	There are two loose black wires in this kit. Plug each into the rear side markers (lamp socket O). Route the ring terminal end of black wires to the rear panel support (near fuel tank filler) and attach to ground.
M		YELLOW	LH Stop / Tail	Route this wire to the LH tail lamp, cut to length, install terminal J and plug this wire into connector F from above. Install terminal C and connector E on the tail lamp pigtail A, maintaining color continuity with connector F. Plug connector E into connector F.
N		DK GREEN	RH Stop / Tail	Route this wire to the RH tail lamp and cut to length and install terminal J. Plug this wire into connector F from above. Install terminal C and connector E on the tail lamp pigtail A, maintaining color continuity with connector F. Plug connector E into connector F.
O				
P				
Q		LIGHT GREEN	Back up lamp feed	Route this wire to the LH back up lamp, trim to length, install terminal N and plug into connector H as shown on sheet 6. Route the remaining portion of the LT GREEN wire over to the RH back up lamp, trim to length, install terminal J and plug into connector H as shown on sheet 6.
R		WHITE	Courtesy ground	At the driver's side kick panel area, cut this wire, double it with the cut off portion using terminal D, and plug into connector E maintaining color continuity with the mating connector in the courtesy lamp kit (500708 bag N). If you are using a dome lamp, route the loose end of this wire to the rear pillar area of the trunk, install terminal J and plug into connector F in location shown on Sheet 6.
S				(Note: a factory dome lamp harness will also plug into this connector, if you are not replacing the headliner at this time.) Install the loose white wire S (supplied with terminal installed) into the dome lamp. Route the other end of this wire to connector F (on white wire) location and trim to length. Install terminal C and plug into connector E, maintaining color continuity with the white wire in connector F.
T				
U				

NOTE: You have been provided with LH tail lamp (AA) and RH tail lamp (BB) pigtail assemblies which have already been assembled for you. Be certain to maintain the color orientation of the yellow/brown and dk. green/brown tail lamp connections when installing the main rear body harness as outlined below. Once you have assembled the main rear body harness, simply plug in the corresponding pigtail assemblies AA or BB as shown on sheet 6 to complete your stop/tail lamp connections.

NOTE: You have been provided with LH and RH back up lamp pigtail assemblies which have already been assembled for you. Once you have assembled the main rear body harness from above, simply plug in the corresponding pigtail assemblies CC as shown on sheet 6 to complete your back up lamp connections.

1970 - 73 Firebirds Rear Body (cont'd)

ORANGE	Courtesy Lamp	At the driver's side kick panel area, cut this wire, double it with the cut off portion using terminal D, and plug into connector E maintaining color continuity with the mating connector in the courtesy lamp kit (500708 bag N). If you are using a dome lamp, route the loose end of this wire to the rear pillar area of the trunk, install terminal J and plug into connector F in location shown on Sheet 6. (Note: a factory dome lamp harness will also plug into this connector, if you are not replacing the headliner at this time.) Install the loose orange wire S (supplied with terminal installed) into the dome lamp. Route the other end of this wire to connector F (on white wire) location and trim to length. Install terminal C and plug into connector E, maintaining color continuity with the orange wire in connector F.
DK BLUE	Fuel Pump	This wire can be used if you are using an electric fuel pump. Plug the terminated end into the 6 way power disconnect on the dash harness maintaining color continuity with the dk blue wire in the mating connector. Route the other end to a fuel pump relay (not included in this kit, but available from American Autowire).

1970 - 73 Firebirds Misc. Dash Connections

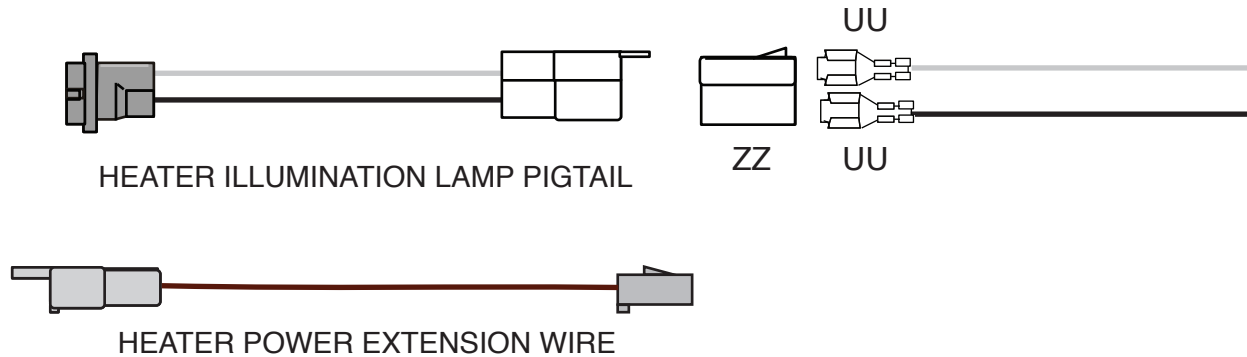

On the 1970-73 Firebird models, the heater harnesses were always serviced as a separate harness and simply plugged into a main power feed on the dash harness. We have included a brown power wire extension assembly in this kit to plug onto the main Camaro dash harness (510033). Use your instruction sheet 510033, page 2, branch 2, item # 11 and plug the brown power wire extension onto the Camaro dash harness at that location. This will extend your heater and A/C power feed wire over to the proper location for a Firebird. If you need a new heater harness, contact our Sales office for the proper harness for your application. If you are running aftermarket heat or A/C, this will be your main keyed power source for that system. In addition to this power feed, there is also an illumination lamp at the same location of the main Camaro dash harness on the opposite side from the power feed wire. Cut the lamp socket off of black and gray wires, install terminals UU on each wire, then plug them into connector ZZ maintaining color continuity with enclosed heater lamp pigtail from above. Plug the pigtail assembly into this connection to extend your heater and A/C illumination lamp over to the proper location for a Firebird.

USE THIS SHEET TO CONNECT TO AN ORIGINAL FACTORY WARNING LAMP INSTRUMENT CLUSTER WITH A CIRCUIT BOARD CONNECTION

1970-71 FIREBIRD
CIRCUIT BOARD CONNECTOR
WITH WARNING LIGHTS

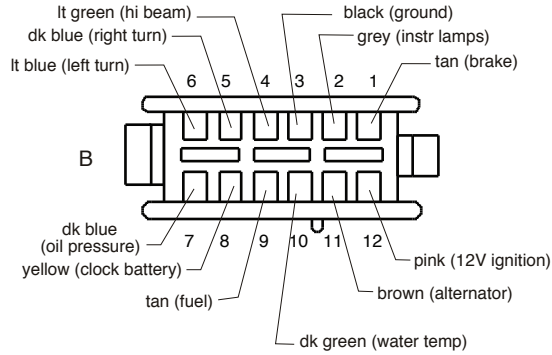

1972-73 FIREBIRD
CIRCUIT BOARD CONNECTOR
WITH WARNING LIGHTS

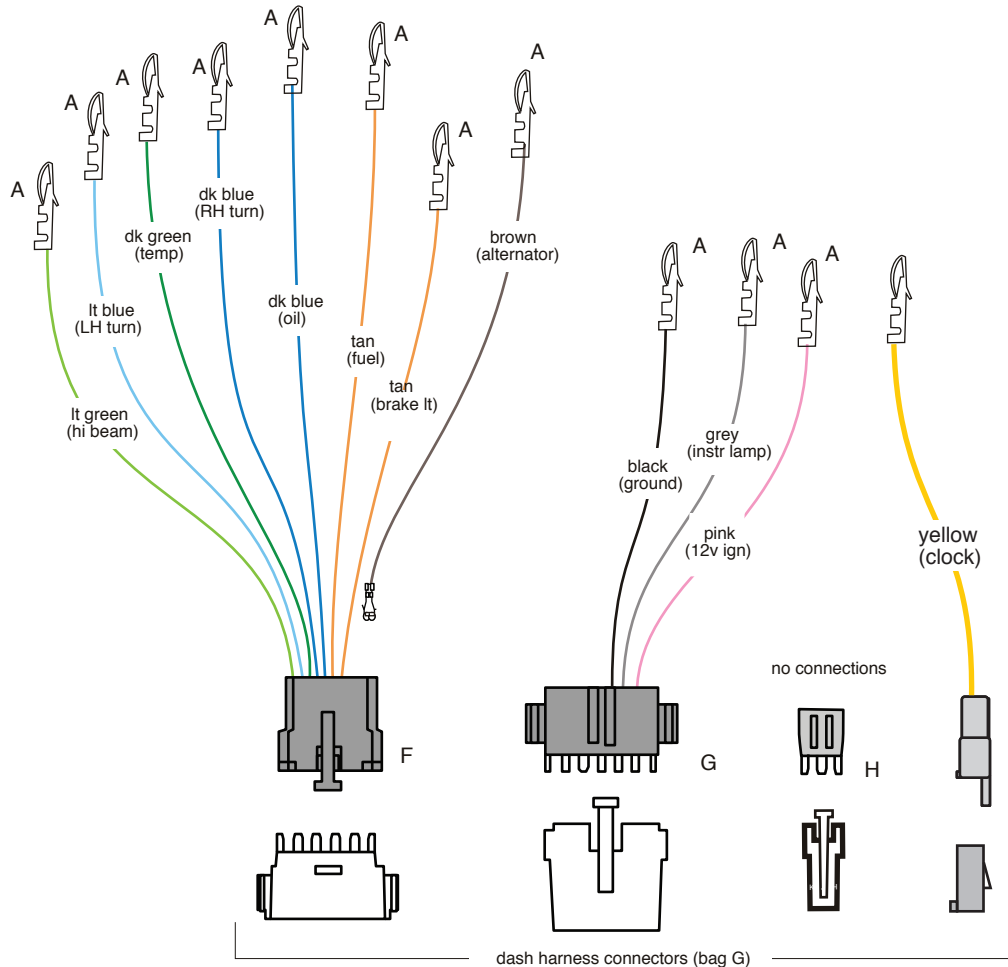
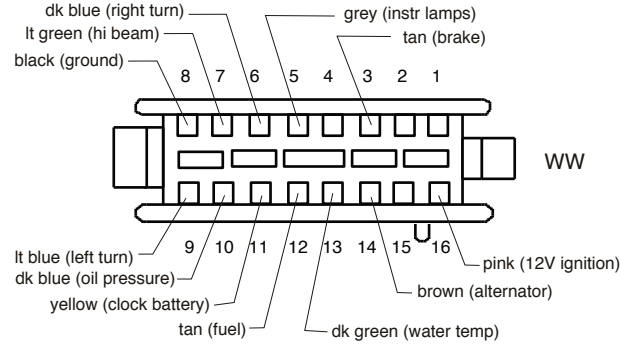

NOTE: In this portion of the kit, you will find connector WW (for 1972-73 applications) and a clock wire assembly that are necessary to complete your dash cluster installation. All other parts necessary to complete this part of your installation will be found in the 1970-3 Camaro cluster connection kit, 510044 (bag H). Use the wire pin-out instructions on this page to complete the connection to your stock Firebird dash cluster assembly with warning lamps.

510174
1970 - 73 Firebird
Dash Cluster Section
92969400 instruction rev 1.0 2/20/2012

Classic Update Series

USE THIS SHEET TO CONNECT TO AN ORIGINAL FACTORY GAUGE INSTRUMENT CLUSTER WITH A CIRCUIT BOARD CONNECTION

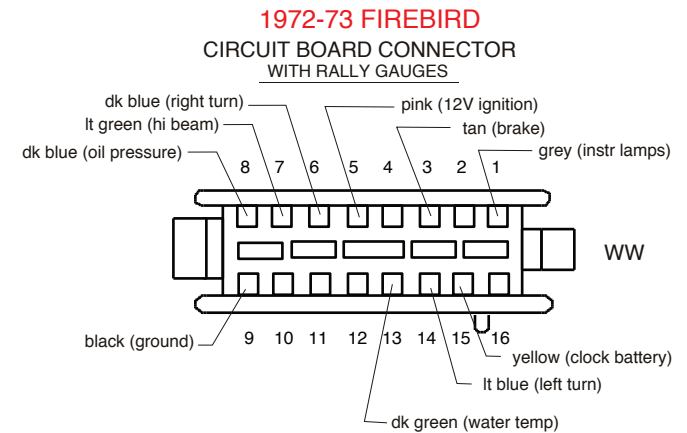
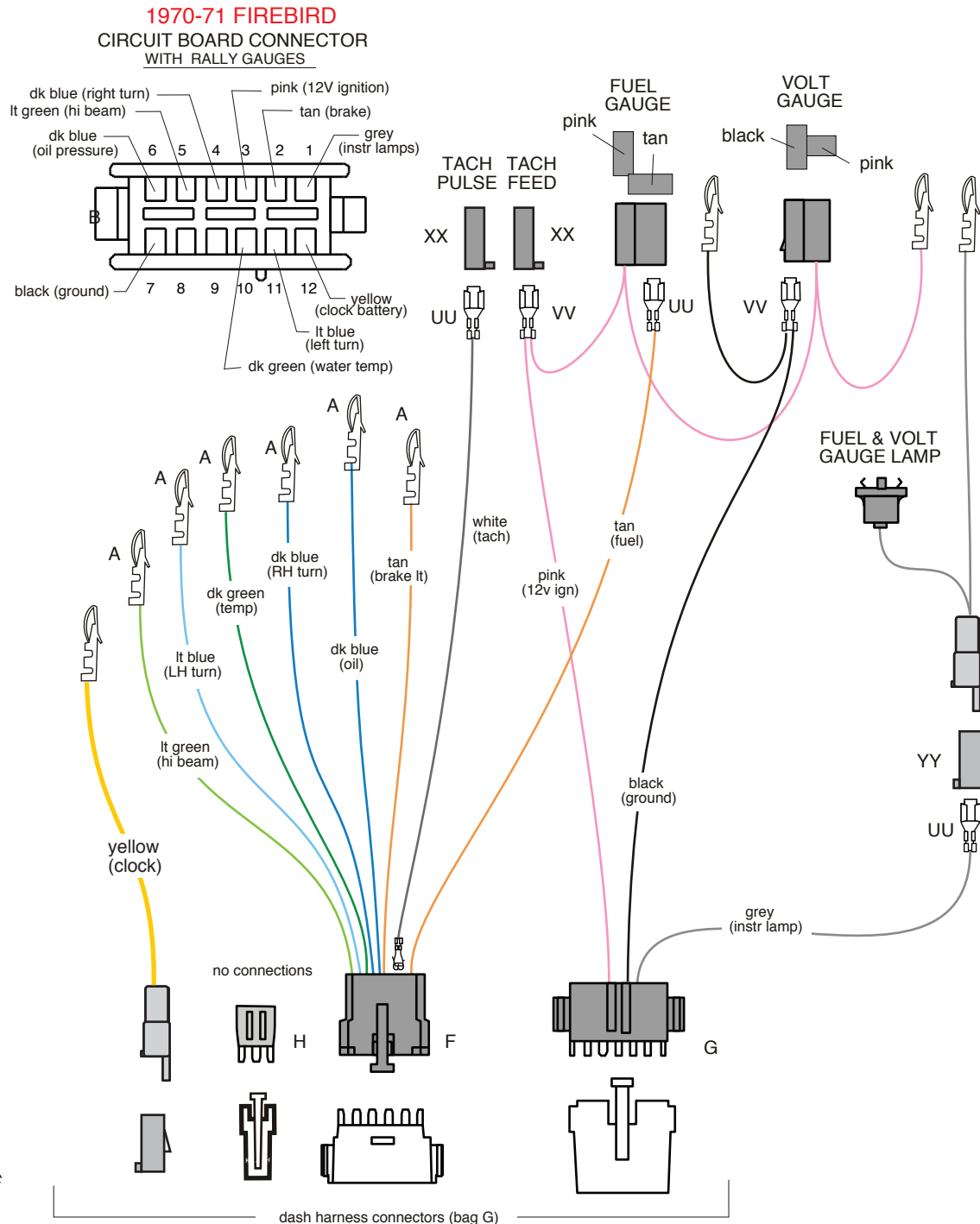

NOTE: In this portion of the kit, you will find connector WW (for 1972-73 applications), a clock wire assembly, a rally gauge wire assembly, and a rally gauge lamp assembly that are necessary to complete your dash cluster installation. There are several loose piece terminals and connectors (UU, VV, XX, YY) that are also included to help complete this portion of the kit. All other parts necessary to complete this part of your installation will be found in the 1970-3 Camaro cluster connection kit, 510044 (bag H). Use the wire pin-out instructions on this page to complete the connection to your stock Firebird dash cluster assembly with factory rally gauges.

510174
1970 - 73 Firebird
Dash Cluster Section
92969400 instruction rev 1.0 2/20/2012