

11A - from Dimmer switch
 11C - high out
 12A - from Dimmer switch
 12B - low out
 115A - from fuse panel
 500A - from FOG Switch
 500B - to FOG Lamps

NOTE: Your new underdash courtesy lamp extensions use # 631 bulbs (not included with this kit). They may be purchased at any auto parts store.

PART # **510177**

DESCRIPTION:
1969-70 Mustang Classic Update Series Kit

92969421 Rev 5.0 5/15/2014

Main Fuse Panel Installation Instructions

The Main Fuse Panel harness is designed to be mounted under the dash to the left of the original fusebox / bulkhead pass thru hole in the firewall. Below, you will find a picture showing the fusebox mounted in an actual car. Once mounted in the firewall, the harness will route exactly as the original did. The technical narative representations of the main dash harness on the following pages show each circuit branch and identifies each connection by its color, circuit number, and function. Follow these as well as the detailed drawing on pages 7 and 8 for the individual circuit connections to complete your installation.

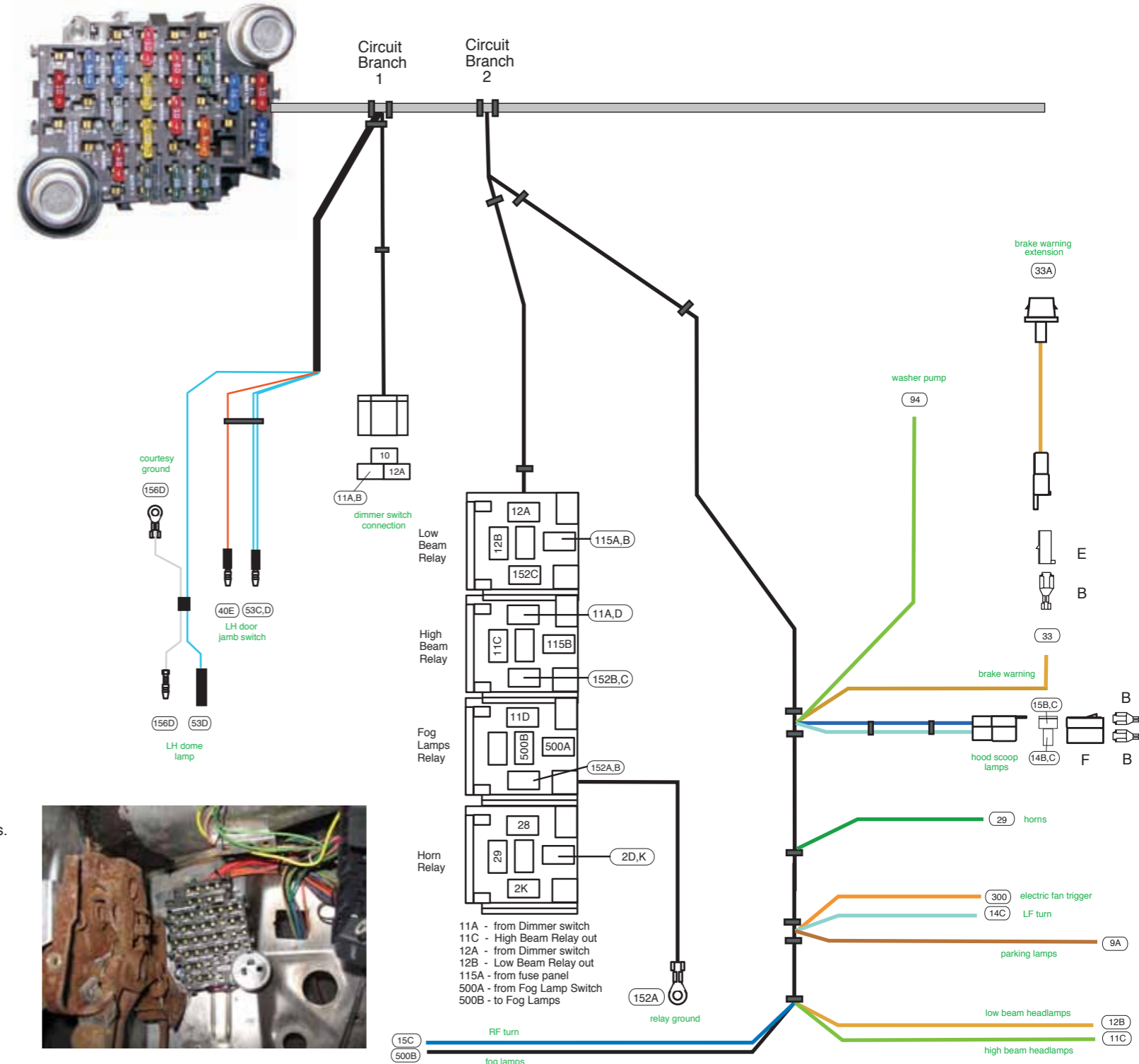

Circuit Branch 1- Under Dash connections

Wire	Wire color	Printing	Procedure
Dimmer Switch connector.			
10	Yellow	Dimmer Switch Feed	Connect to Dimmer Switch.
11A,B	Light Green	Headlight Hi Beam	Connect to Dimmer Switch.
12A	Tan	Headlight Low Beam	Connect to Dimmer Switch.
Left Hand Dome Lamp Feed Wires.			
53C,D	Light Blue	12V Ctsy Sw	Connect to Left Hand door jamb switch provided in the 510181 parts kit.
40E	Orange	12V Battery Fused	Connect to Left Hand door jamb switch provided in the 510181 parts kit.
53D	Light Blue	12V Ctsy Sw	Connect to Left rear dome lamp.
156D	White	Ctsy Ground	Connect the bullet terminal end to the left rear dome lamp. The ring terminal end must be connected to a good chassis ground.

Circuit Branch 2- Front Lighting connections See page 7, "Figure A" for typical connections. Loose piece terminals and connectors are located in kit 510181.

Wire #	Wire color	Printing	Procedure
Relay Pack			
The 4 gang relay panel is directly wired and requires no internal wiring. The only connection required is to attach the relay ground wire (152A) to a good chassis ground. Two relays control the headlight low beam and high beam circuits allowing for the use of high powered halogen lamps without creating an extra load on the factory headlamp and dimmer switches. A third relay controls the fog or driving lamp circuit and automatically shuts the fog or driving lamps off whenever the high beam lamps are applied in accordance with 50 state Federal law. The last relay is for your horn circuit.			
152A	Black	Ground	Connect to a good chassis ground.
94	Light Green	Washer Pump Feed	Route this wire to your washer pump. This is the switched 12 volt feed to operate the pump. You will need to use your original ground wire assembly from your pump.
33	Tan	Brake Switch	This is the brake warning light switch wire for braking systems using a brake warning light. An extension to the switch, wire "33A" with a late model mold-on connector, has also been provided. Route wire 33 to the brake warning switch, cut to length, install terminal "B", plug into connector "E" (Parts in 510179 kit), plug the completed lead into the brake warning extension wire 33A. The other end of the brake warning extension can then be plugged onto the brake warning switch. This AAW kit switches ground, so only 1 lead is necessary. If you are using your stock brake warning switch, that system switched power in it's original configuration. You will need to cut one of the wires from your original switch connector and splice AAW wire 33 onto that original wire pigtail. Next, cut the other wire on the original connector, install a ring terminal on that wire, and ground that wire to the chassis.
14B,C	Light Blue	Left Front Turn	This is the connection for the hood scoop mounted directional lights. Mating connector and terminals "B and F" to complete this branch can be found in the 510179 loose piece dash kit if you are using a stock hood with these lamps. Connect to the horn power terminal. NOTE: If your horn has a separate ground terminal, you must supply the wire for that ground terminal as it is not included in the kit. A stock horn is self grounding through it's case and bracket.
15B,C	Dark Blue	Right Front Turn	Connect to the left front directional lamp socket. If you are using a single front directional light with an 1157 or dual filament bulb, this wire would be connected to the high intensity filament of the LH front running light.
29	Dark Green	Horn	Connect to the right front directional lamp socket. If you are using a single front directional light with an 1157 or dual filament bulb, this wire would be connected to the low intensity filament of each of the front running lights. An in-line splice of this wire or a double up of this wire at the left front parking lamp will be necessary to accommodate the wiring of both of the front park / running lights. Connectors, terminals, and lamp sockets have been provided to make the necessary connections and can be found in the 510181 parts kit.
14C	Light Blue	Left Front Turn	Using the terminals and connectors supplied in bag 510181, connect these wires along with the headlight ground wires to the headlight connectors according to the orientation in the diagram on page 7. Figure A. Select the light green Headlight Hi Beam wire (11C), route to the LH outer headlamp, cut to length, double with the cut off portion using terminal W, and plug into connector A as shown on sheet 7. Select the remaining light green wire, route to the LH inner headlamp, cut to length, double with the cut off portion using terminal W, and plug into connector T as shown on sheet 7. Select the remaining light green wire, route to the RH inner headlamp, cut to length, double with the cut off portion using terminal W, and plug into connector T as shown on sheet 7. Select the remaining portion of the light green wire, route to the RH outer headlamp, cut to length, install terminal C, and plug into connector A as shown on sheet 7.
15C	Dark Blue	Right Front Turn	Select the tan Headlight Low Beam wire (12B), route to the LH outer headlamp, cut to length, double with the cut off portion using terminal W, and plug into connector A as shown on sheet 7. Select the remaining tan wire, route to the RH outer headlamp, cut to length, install terminal C, and plug into connector A as shown on sheet 7.
300	Orange	Electric Fan	Connect this wire to your fog lamp power lead wires. An in-line splice or double up of the wire at the left fog lamp before routing to the right fog lamp will be necessary. If the fog lamps have a separate ground wire, you must supply those wires as they are not included in the kit.
9A	Brown	Park Lights	
11C	Light Green	Headlight-Hi Beam	
12B	Tan	Headlight-Low Beam	
500B	Black	Fog Lamps	



www.americanautowire.com 856-933-0801

PART # **510177**

DESCRIPTION:
1969-70 Mustang Classic Update Series Kit

92969421 Rev 5.0 5/15/2014

Circuit Branch 3 - Under Dash connections.

Wire #	Wire color	Printing	Procedure
Fog or driving lamp switch connection wires			
40	Orange	12V Battery Fused	Connect to "Feed In" on your fog lamp switch (if so equipped).
500A	Black	Fog Lamps	Connect to "Feed out" on your fog lamp switch (if so equipped).

LH Courtesy lamp connection
 Plug in your Left Hand under dash courtesy lamp assembly here. The function of each wire is as follows:

53A,C	Lt Blue	12V Ctsy Sw	Courtesy Light power.
156A	White	Crtsy ground	Courtesy Light ground. Attach ring terminal to a good chassis ground.

Turn Signal Switch connector
 If you are using a stock Ford turn signal switch and steering column, refer to Diagram 'A' and "Table A" on this page, to mate the original wires in your column to the AAW Turn Signal Switch wires. This kit is designed to plug into and function with a GM style turn signal switch. Our dash harness turn signal connector mates to the GM 3 7/8" plug type that was used on most 1969-1974 GM, IDIDIT, and many other aftermarket steering columns. Starting from 1975 on up, the GM switch began using a 4 1/4 inch connector in place of the 3 7/8" one. That connector is from the same family and uses the same terminals. By using the supplied mating connector (L) and terminals (M) located in the loose piece kit bag of the dash harness (510179), it is easy to adapt any steering column to the kit. The function of each of the AAW wires within the cavities are as follows:

28	Black	Horn switch	Horn button ground to the horn relay trigger
28A	Black	Horn Relay Ground	Ground wire for use with stock Ford column only (not used with an aftermarket column).
14A,B	Light Blue	Left Front Turn	Feeds the left front turn lamp bulb high filament ,the left hood mounted turn signal bulb, and the left turn dash indicator lamp.
15A,B	Dark Blue	Right Front Turn	Feeds the right front turn lamp bulb high filament, the right hood mounted turn signal bulb, and the right turn dash indicator lamp.
27	Brown	Turn Sw - Hazard	4 way hazard power feed wire from the Hazard flasher "L" terminal.
16	Purple	Turn Switch Feed	Turn signal power feed wire from the Turn Signal flasher "L" terminal.
18	Yellow	Left Rear Turn	Feeds the left rear turn and brake lamp bulb high filament.
19	Dark Green	Right Rear Turn	Feeds the right rear turn and brake lamp bulb high filament.
17A	White	Brake Switch	Power feed wire from the output side of the brake switch.
17B	Light Blue	Third Brake	Power feed wire from the output side of the brake switch to the third brake light connection at the rear body connector.

Circuit Branch 4 - Under Dash connections.

Wire #	Wire color	Printing	Procedure
Rear Body Wire connections.			
This connector plugs into the Rear Body Kit 510052. See that sub-kit for specific installation instructions and circuit functions.			
Accessory Feed Wire connections.			
100	Tan	Accessory Fused	Accessory Fused power source.
103	Tan	Fuel pump	Connect to the power input terminal of a fuel pump relay.
104	Red	Power Locks	Connect to the power input of the power locks switch or any other battery powered accessory.
107	Pink	Ignition Fused	Ignition Fused power source.
116	Pink	Power Windows	Connect to the power input of the power windows switch or any other ignition powered accessory.
Instrument Cluster ground.			
150A,B	Black	Ground	Connect to a good chassis ground.
Headlight switch connector.			
The function of each wire is as follows:			
2F	Red	12V Battery	12 volt battery power to the switch.
9A,B,C	Brown	Park Lights	Power lead wires to the parking and tail light circuits.
44	Dark Green	Dash Lights	Power lead wire to the dash lights .
10	Yellow	Dimmer Sw feed	Headlight power output to the Dimmer Switch.
40C,D,E	Orange	12V Battery	Fused Courtesy Light battery power feed from fusebox.
53A,B	Lt Blue	12V Ctsy Sw	Courtesy Light switched battery power.

Table "A"
AAW Turn Signal Switch wires to stock 1969-70 Mustang turn signal switch.

AAW Wire #	AAW Wire color	AAW Wire Printing	Ford Wire Color
14A,B	Light Blue	Left Front Turn	Green with white stripe
15A,B	Dark Blue	Right Front Turn	White with blue stripe.
16	Purple	Turn Switch Feed	Blue
17A,B	White	Brake Switch	Green
18	Yellow	Left Rear Turn	Green with orange stripe.
19	Dark Green	Right Rear Turn	Orange with blue stripe.
27	Brown	Turn Sw - Hazard	White with red stripe.
28	Black	Horn Relay Ground	Yellow
28A	Black	Horn Relay Ground	Blue with yellow stripe.

Note: Ford originally switched power to the horns through the steering column horn button. In this kit, ground is being switched through the original steering column switch to ground a horn relay which switches power to the horns.

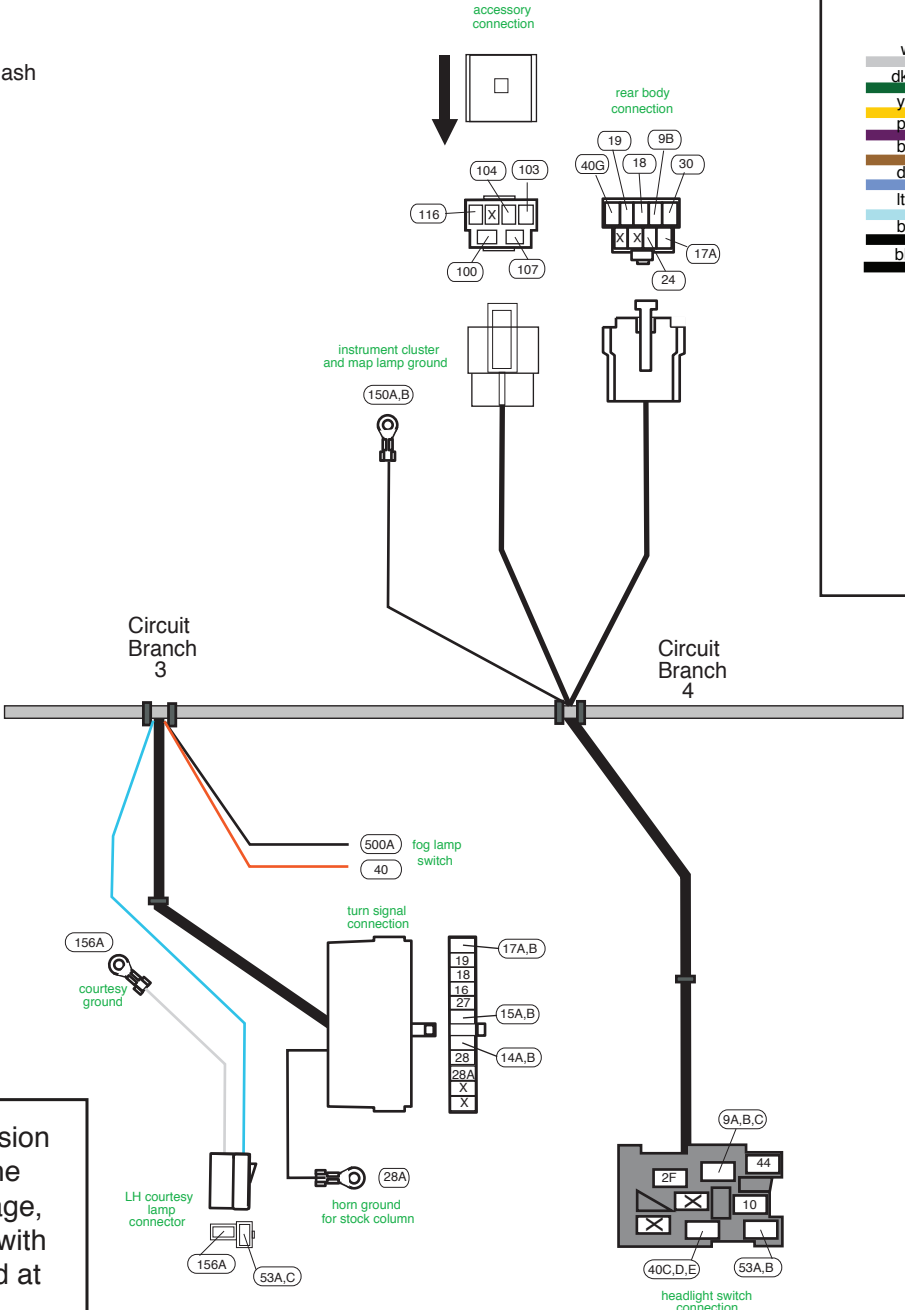
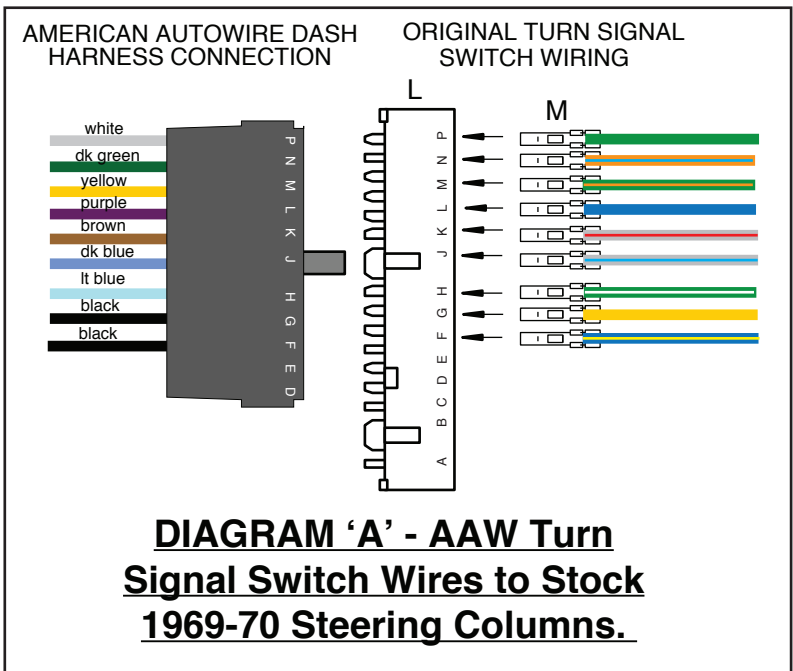

NOTE: The courtesy lamp extension from page 1, that plugs onto the connector at branch 3 on this page, uses a # 631 bulb (not included with this kit). They may be purchased at any auto parts store.



www.americanautowire.com 856-933-0801

PART # **510177**

DESCRIPTION:
1969-70 Mustang Classic Update Series Kit

92969421 Rev 5.0 5/15/2014

Circuit Branch 5 - Under Dash connections

Instrument Cluster connections.

These connections plug into the Instrument Cluster Kit 510186. See that sub-kit for specific installation instructions and circuit functions. NOTE: In the event that you are using an aftermarket gauge package, there are instructions and terminals to complete that task (92965220) located in the 510186 Instrument cluster kit. If you are using an electronic speedometer, connections to the transmission sending unit can be found on this page to the right in figure "A".

Circuit Branch 5 - Engine and Alt. connections See page 8, "Figures B, C, and D" for typical connections. Loose piece terminals and connectors to complete these connections are located in kit # 510181. Procedure

Wire #	Wire color	Printing	Procedure
Alternator connections			
2	Red	12 V Battery	Route this wire to your starter solenoid and connect the ring terminal end with the blue fusible link to the battery terminal on the starter solenoid. Route the other end to the alternator battery stud, install sleeve "R" followed by terminal "D" and attach this completed assembly to the battery terminal of the alternator. (See Figure B)
2H	Light Blue	Fusible Link	See the connection instructions under wire 2.
4D	Brown	Alternator Ign	This wire is the exciter wire for your alternator / voltage regulator. If you are using a one wire alternator, this wire will not be used and should be capped off as it is "hot" in the ignition "on" position. If you are using an alternator that requires an internal or external voltage regulator, this exciter wire must be connected to the "switched or 12v ignition" terminal on your regulator or alternator according to the manufacturer's specifications for the type of alternator / regulator that is being used. An inline diode or resistor may be necessary to eliminate "run on" after being switched off. (AAW recommends a GEN 3 Internally Regulated or 1 wire alternator unit)
Starter Solenoid connections			
6	Purple	Starter Solenoid-S	Route the end that comes out with the heavy red main power feed wire to the "S" terminal on your starter solenoid, cut to length, install sleeve R and terminal U which can be found in grommet and loose piece bag 510181. (See Figure D on page 8)
2A	Red	12 V Battery	Route this wire to your starter solenoid. Cut to length, install terminal "Q", plug into connector "E" as shown on this page (and also as shown on figure D, page 8). Then, as shown on page 8, Figure B, plug connector "E" into the connector on the loose piece brown fusible link wire 2J, then attach the ring terminal on this assembly to the battery terminal on your starter solenoid. (Parts for this connection can be found in the 510179 loose piece kit)
2J	Brown	Fusible Link	See the connection instructions under wire 2A.
Neutral safety and back-up connections			
5	Purple	Neutral Safety Switch	Connect to a NSS terminal on the neutral safety switch. (See figure C, page 8)
6	Purple	Starter Solenoid-S	Connect to the opposite NSS terminal on the neutral safety switch as the 5 wire above. (See figure C, page 8)
24	Lt. Green	Backup Lt Sw-Lights	Connect to the backup light terminal on the neutral safety / back up switch. (See figure C, page 8)
39B	Pink	12 V Ignition	Connect to the backup light power terminal on the neutral safety / back up switch. (See figure C, page 8)
Engine connections			
3F	Pink	Ignition Feed - coil	This is your 12 volt switched power source for the distributor. This can be connected directly to the "bat" terminal on a typical HEI distributor, to a ballast resistor as in a points type distributor, or be used as the ignition power source for an aftermarket ignition module such as an MSD or "Duraspark" module. We recommend consulting your ignition system manufacturer's installation instructions for specific connection requirements (See page 8, figure D for some examples).
31	Dark Blue	Oil Pressure Sender	Connect to the oil pressure sender.
35	Dark Green	Water Temp Sender	Connect to the temperature sender.
39D	Tan	Electric Choke	On carbureted cars, connect to the electric choke terminal.
121	White	Coil - Tach	This can be connected directly to the tach terminal on a typical HEI distributor, to the negative side of the coil, or a tach connection in an aftermarket ignition module such as an MSD module. See the installation instructions for the type of ignition system you are using for specific connection requirements.
400	Yellow	VSS Ground	Connect to the Vehicle Speed Sensor ground lead (used only with an aftermarket electronic speedometer).
401	Purple	VSS Signal	Connect to the Vehicle Speed Sensor signal lead (used only with an aftermarket electronic speedometer).

Wiper motor connection

Route the molded 4 position connector containing the blue, black, red, and white wires back in thru your cowl area as original, and plug the molded connector into your wiper motor molded lead. It is a factory indexed connection and will only install 1 way. No other connections are necessary to complete this task.

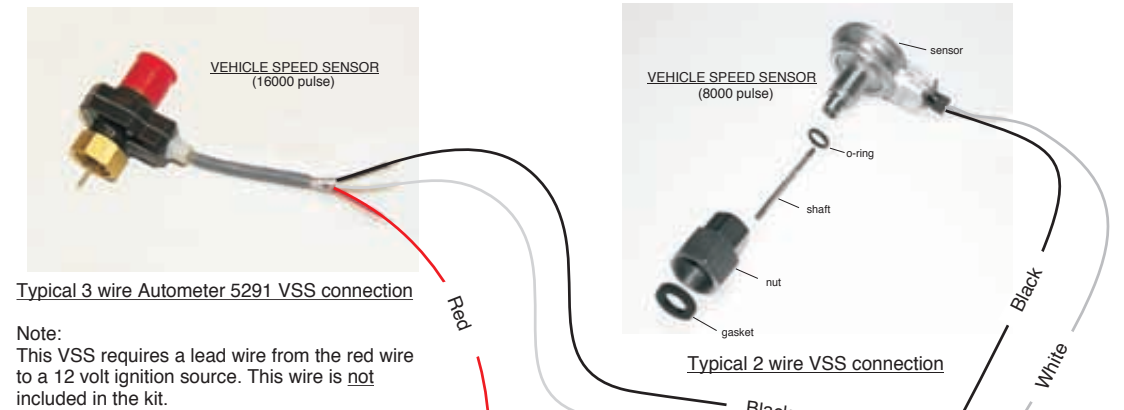

Typical 3 wire Autometer 5291 VSS connection

Note: This VSS requires a lead wire from the red wire to a 12 volt ignition source. This wire is not included in the kit.

FIGURE "A"

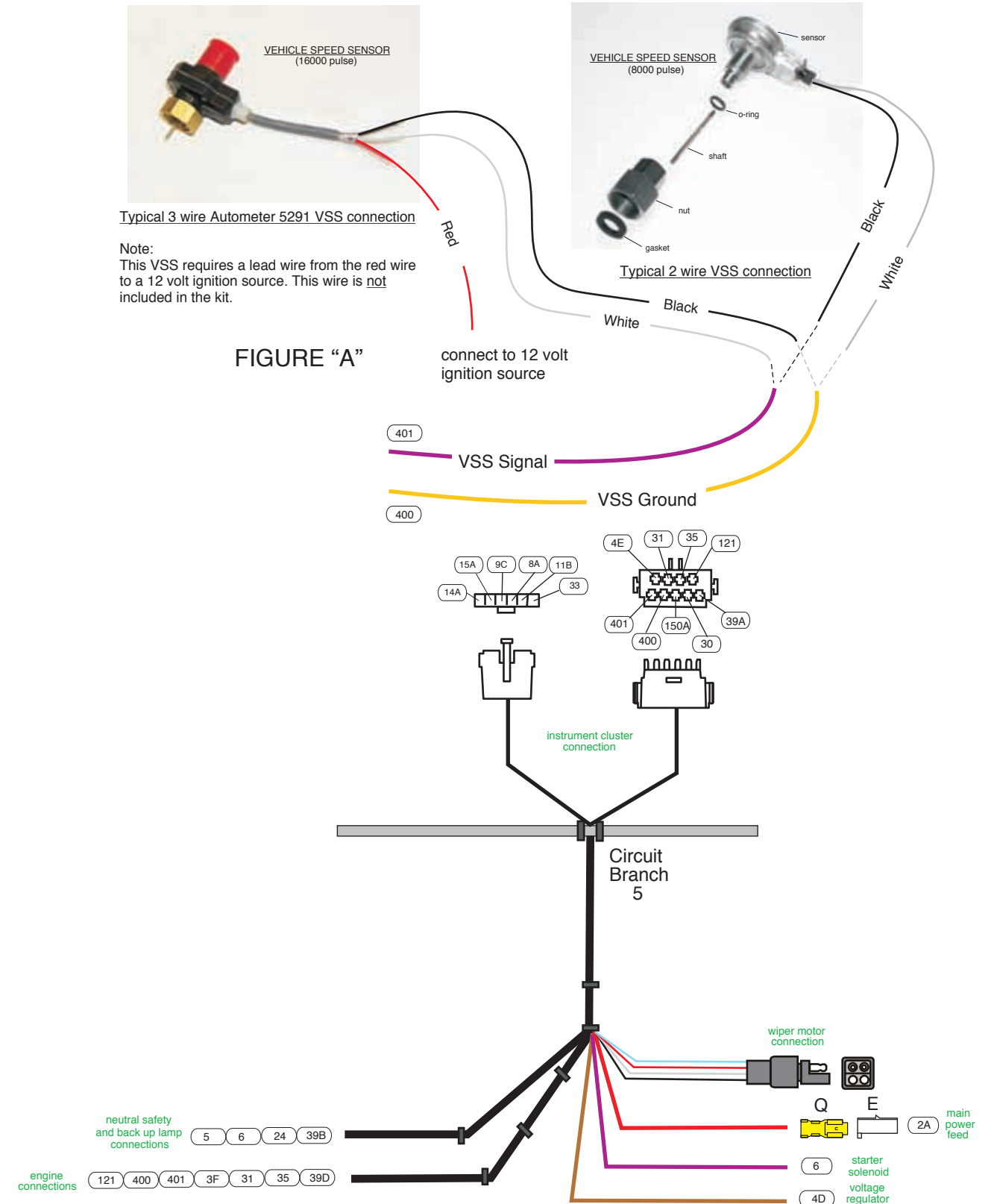

www.americanautowire.com 856-933-0801

PART # **510177**

DESCRIPTION:
**1969-70 Mustang
 Classic Update Series Kit**

92969421 Rev 5.0 5/15/2014

Circuit Branch 6 - Under Dash connections

Wire #	Wire color	Printing	Procedure
--------	------------	----------	-----------

Wiper Switch connections
 Plug the 8 position washer and wiper switch connector directly onto your stock wiper switch. No other connection is necessary.

Radio connections
 43 Tan Radio Ignition power lead to radio for "off" and "on" functions.
 99 Yellow Radio Bat Battery power lead to radio for memory.

Cigarette lighter connection
 40B Orange 12V battery Fused connection to cigarette lighter.

Heater A/C power feed connection
 50 Brown Heater/AC feed This is the fused power lead for the heater or AC control panel. Connect according to the instructions supplied with your aftermarket heater / AC unit. This can also be used as the 12 volt keyed feed wire to the stock heater or A/C system in your 1969 Mustang.

Dash illumination lamps connection
 8B tru F Gray Dash Lights Spare dash lamp feeds for any accessory dash lamps needed including the radio lamp, ashtray lamp, etc.

Brake Switch connector
 40A Orange Brake Switch 12V feed Connect to Brake Switch. This is the 12 volt fused battery feed to the brake lamp switch.
 17B White Brake Switch Connect to Brake Switch. This is the 12 volt output from the brake switch to the turn signal switch.

Ignition Switch connector
 3A Pink Ignition Feed Connect to the provided 1967 style ignition switch.
 5 Purple Neutral Safety Switch Connect to the provided 1967 style ignition switch.
 2B Red 12V Battery Connect to the provided 1967 style ignition switch.
 4A,E Brn & Brn/Wt Ignition Sw Accy Install on the ignition switch stud after the main switch connector has been plugged in.

Circuit Branch 7 - Under Dash connections

Wire #	Wire color	Printing	Procedure
--------	------------	----------	-----------

These connections will plug into your stock map lamp, glovebox, and clock harness.
 40D,F Orange 12V Battery 12V battery fused power connection for the map lamp, glovebox, and clock.
 8C Gray Dash Lights Dash lamp feed for clock
 150B Black Ground Ground connection for the map lamp, glovebox, and clock.

Circuit Branch 8- Under Dash connections

Wire #	Wire color	Printing	Procedure
--------	------------	----------	-----------

Console rear courtesy light connection.
 53J Lt Blue 12V Ctsy Sw Courtesy Light power. Connect to your stock console courtesy lamp harness.
 156E White Ctsy Ground Courtesy Light ground. Connect to your stock console courtesy lamp harness.

Circuit Branch 9- Under Dash connections

Wire #	Wire color	Printing	Procedure
--------	------------	----------	-----------

RH Courtesy lamp connection
 Plug in your Right Hand under dash courtesy lamp assembly here. The function of each wire is as follows:

53B,E,J Lt Blue 12V Ctsy Sw Courtesy Light power provided in the 510181 parts kit.
 156B,E White Crtsy ground Courtesy Light ground provided in the 510181 parts kit.
 156B White Crtsy ground Attach ring terminal to a good chassis ground.

Circuit Branch 10- Under Dash connections

Wire #	Wire color	Printing	Procedure
--------	------------	----------	-----------

Right Hand Dome Lamp Feed Wires.
 53E,F Light Blue 12V Ctsy Sw Connect to the Right Hand door jamb switch.
 40F Orange 12V Battery Fused Connect to the Right Hand door jamb switch.
 53F Light Blue 12V Ctsy Sw Connect to the Right rear dome lamp.
 156C White Ctsy Ground Connect the bullet terminal end to the right rear dome lamp. The ring terminal end must be connected to a good chassis ground.

NOTE: The courtesy lamp extension from page 1, that plugs onto the connector at branch 9 on this page, uses a # 631 bulb (not included with this kit). They may be purchased at any auto parts store.

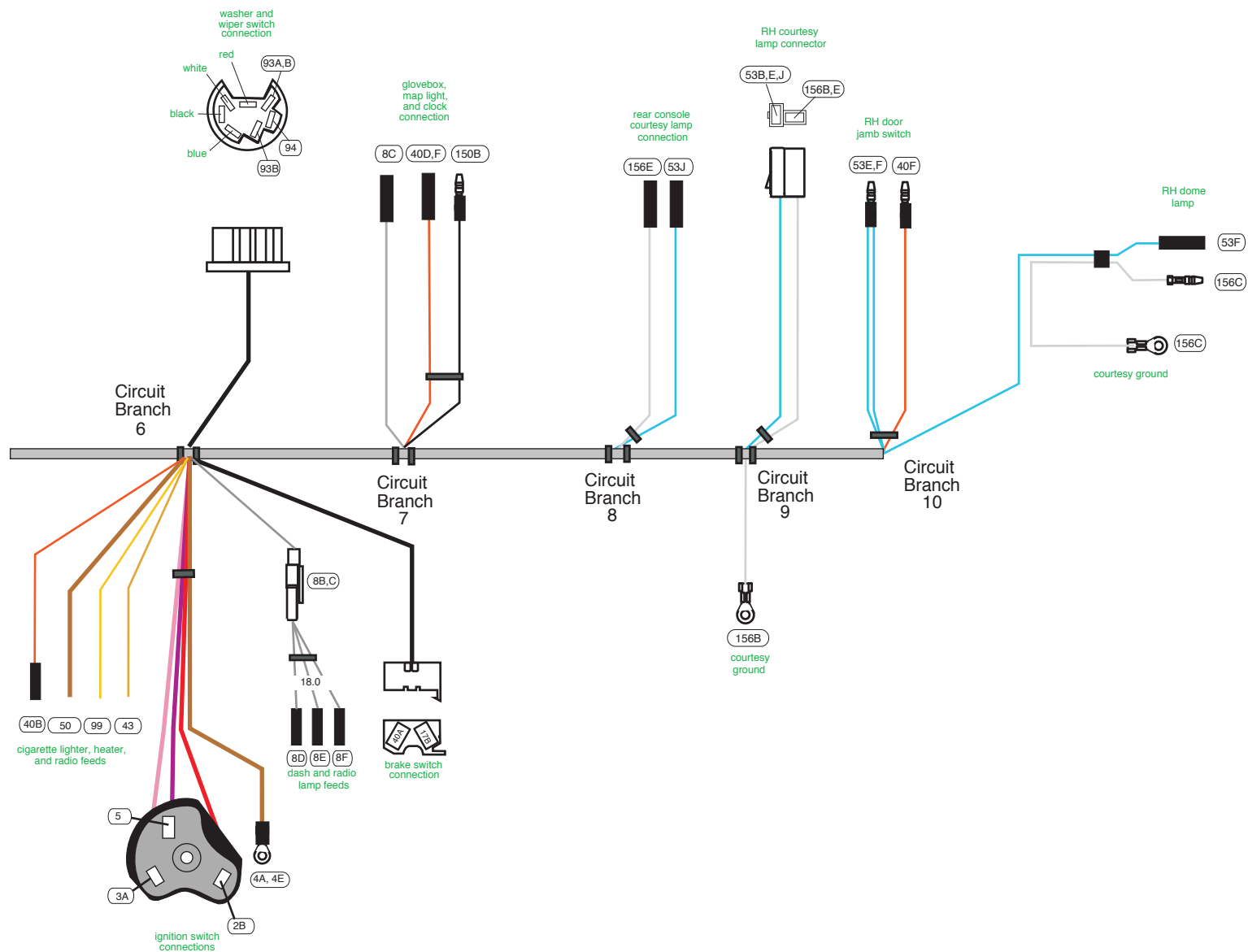

www.americanautowire.com 856-933-0801

PART # **510177**
 DESCRIPTION:
1969-70 Mustang Classic Update Series Kit
 92969421 Rev 5.0 5/15/2014

Fusebox Mounting Hole Template

Choose to work either inside or the outside the car and align the template to the upper and outer pinch welds, and then locate the OEM hole in the firewall.

Once the template is located securely in place, use a center punch and set the two points which you will need to drill out. Using a 1/8" drill bit, carefully drill the two new fuse box mounting holes in your firewall.

Be sure to use some type of sealer on each of the two mounting screws before running them into the two new mounting holes in the firewall as the screws will protrude into the front wheelhouse area.

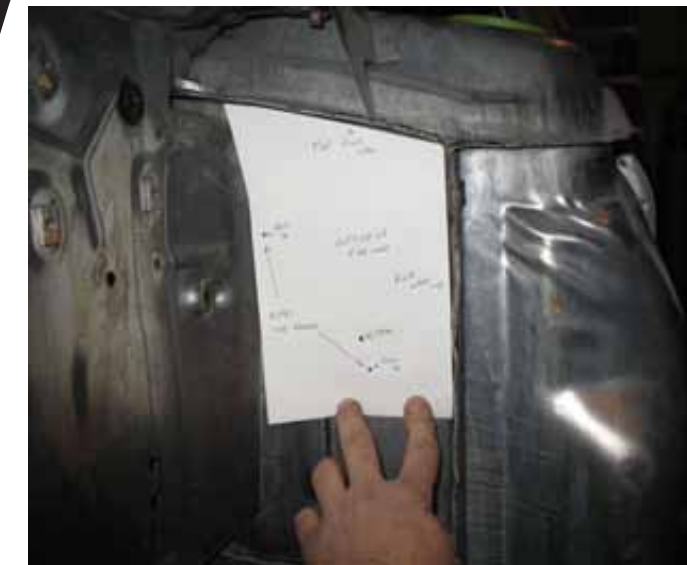
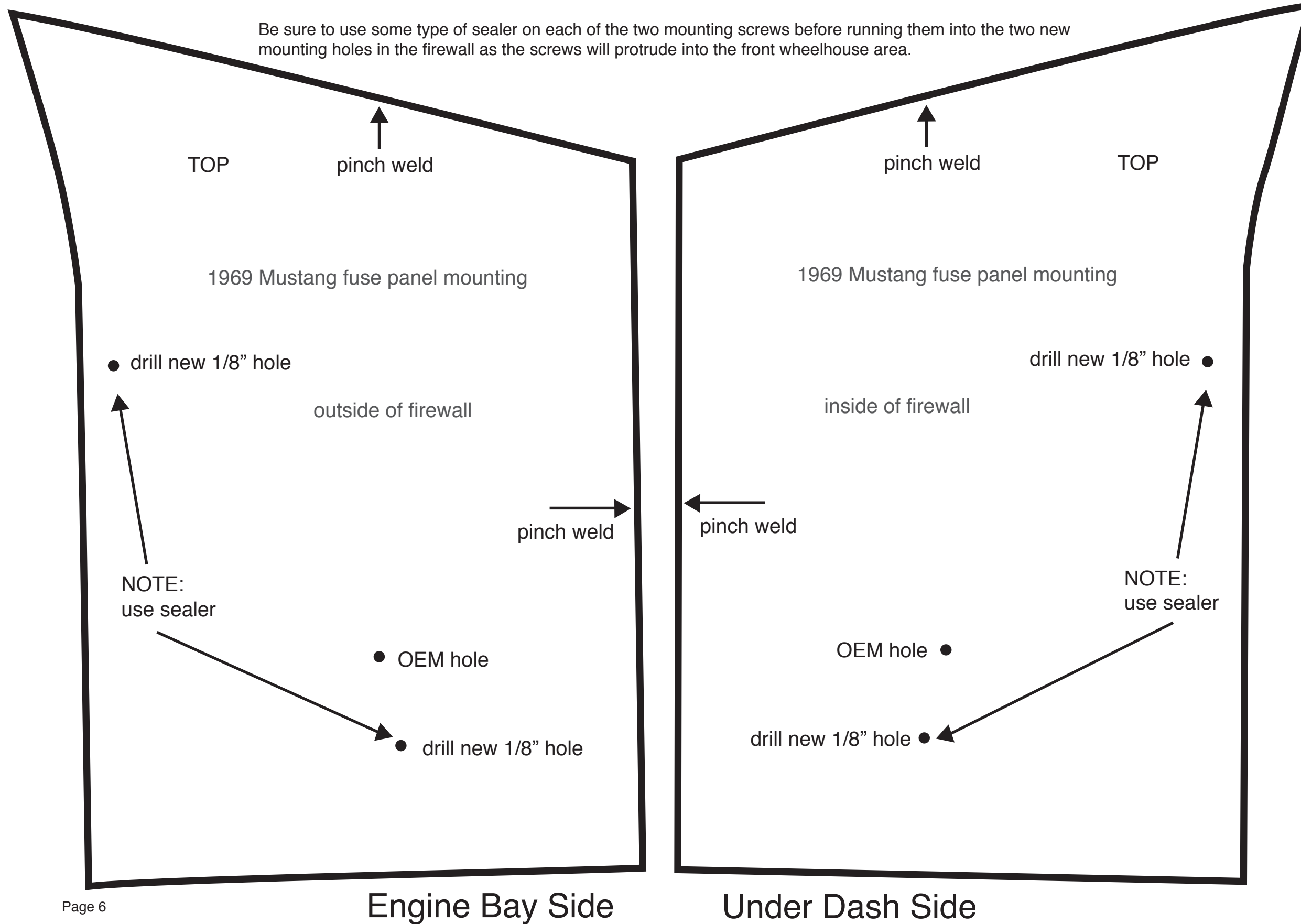

Engine Bay Side



Under Dash Side

PART #	510177
DESCRIPTION:	1969-70 Mustang Classic Update Series Kit
92969421	Rev 5.0 5/15/2014

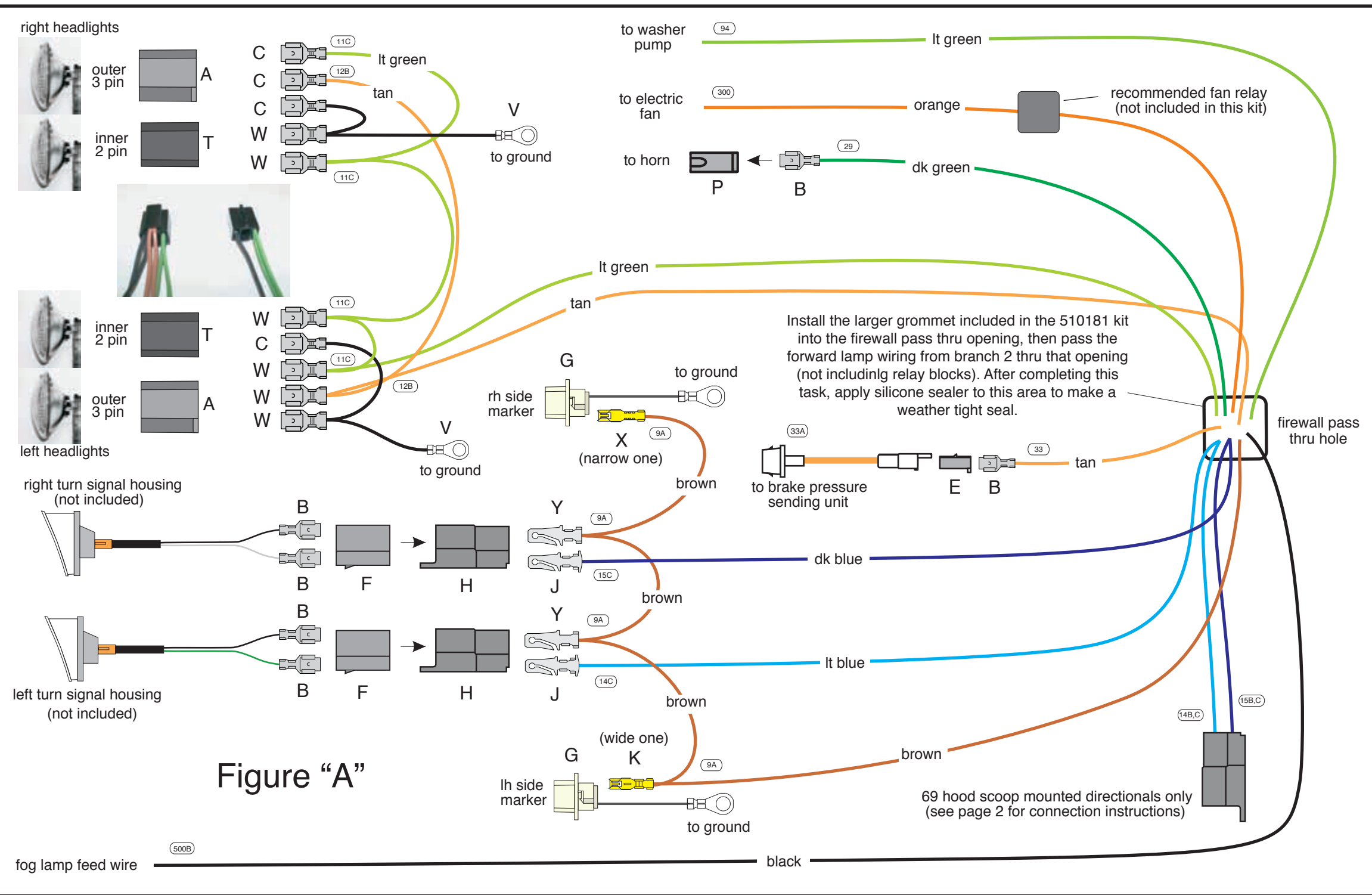

FORWARD LAMP HARNESS OPENING

The picture above shows the forward lamp wires exiting the original firewall bulkhead pass-thru hole. Even though it has not been done in this picture, please take note to install the larger of the 2 grommets found in the 510181 kit into this opening PRIOR to bringing the forward lamp wires thru the opening, and out into the engine compartment.



www.americanautowire.com 856-933-0801

FORWARD LAMP, ELECTRIC FAN, HORN, BRAKE WARNING, AND WASHER PUMP CONNECTIONS

NOTE: The terminals and connectors listed on this page and denoted with UPPER CASE LETTERS to help you complete the various connections to your lamps, horns, switches, etc. can be found in your loose piece grommet and parts kit, P/N 510181 (with the exception of terminal B and connector E which will be found in the 510179 main dash harness loose piece kit).

The identifications, colors, and functions for all of the wires listed in "Figure A" on this page can be found on page 2, branch 2 of this main instruction set. AAW suggests and recommends using both pages 2 and 7 to complete the installation of the forward lamp and washer pump connections.

PART # **510177**
 DESCRIPTION:
1969-70 Mustang Classic Update Series Kit
 92969421 Rev 5.0 5/15/2014

Install terminal Q and connector E onto red main power wire 2A from page 4, branch 5. After completing this task, plug the completed red wire into the brown fuseable link wire 2J as shown in "Figure B" below.

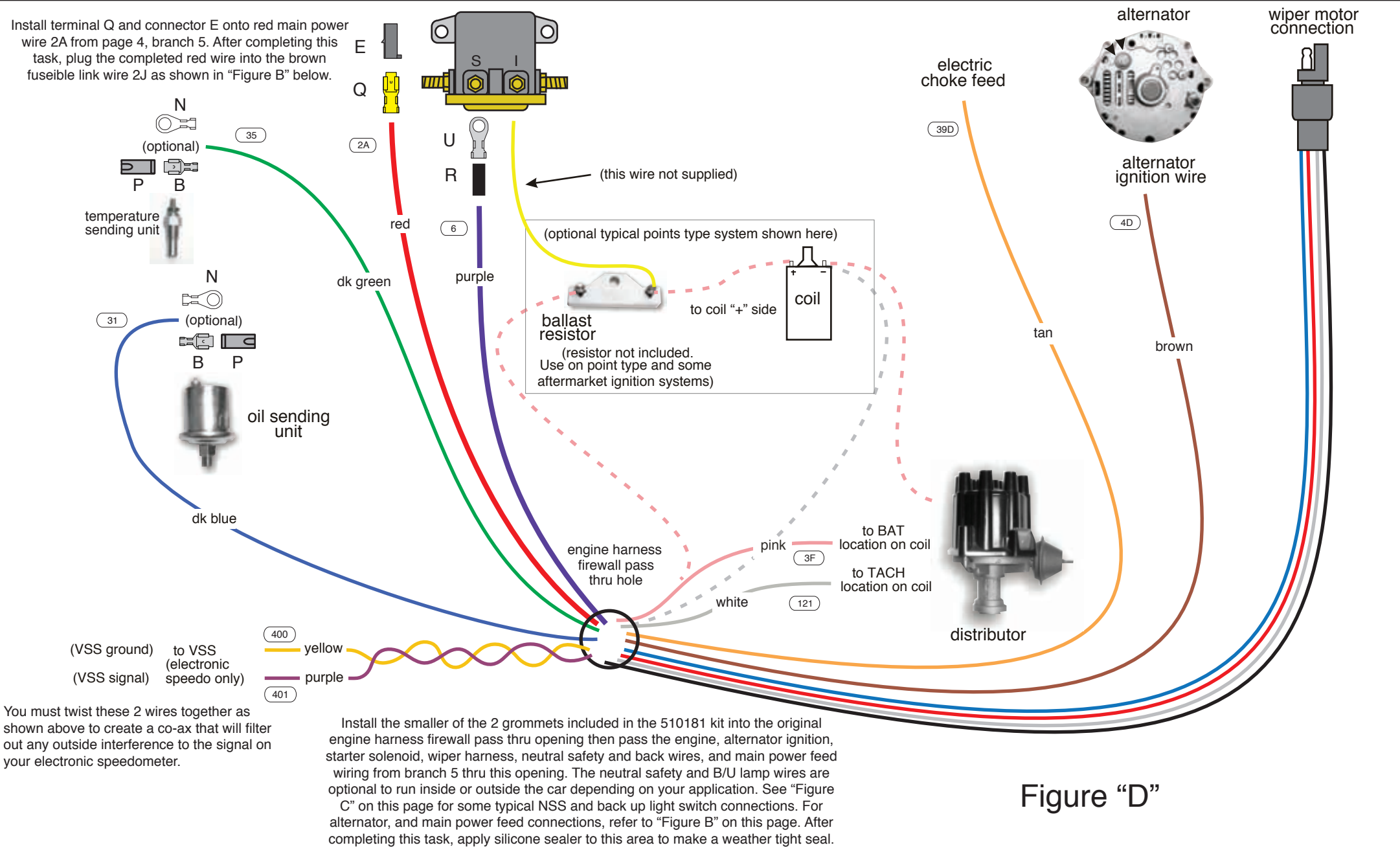

Figure "D"

ENGINE, ALTERNATOR, MAIN POWER, WIPER MOTOR, AND NSS CONNECTIONS

NOTE: The terminals and connectors listed on this page and denoted with UPPER CASE LETTERS to help you complete the various connections to your ignition coil / control unit, temp and oil senders, electric choke, starter solenoid, alternator / regulator, main power, alternator power, wiper motor, neutral safety, and back up switch can be found in your loose piece grommet and parts kit, P/N 510181.

The identifications, colors, and functions for all of the wires listed in "Figures B, C, and D" on this page can be found on page 4, branch 5, of this main instruction set. AAW suggests and recommends using pages 4 and 8 to complete the installation of the engine, main power, and alternator connections.

Main system power feed and alternator power feed connections.

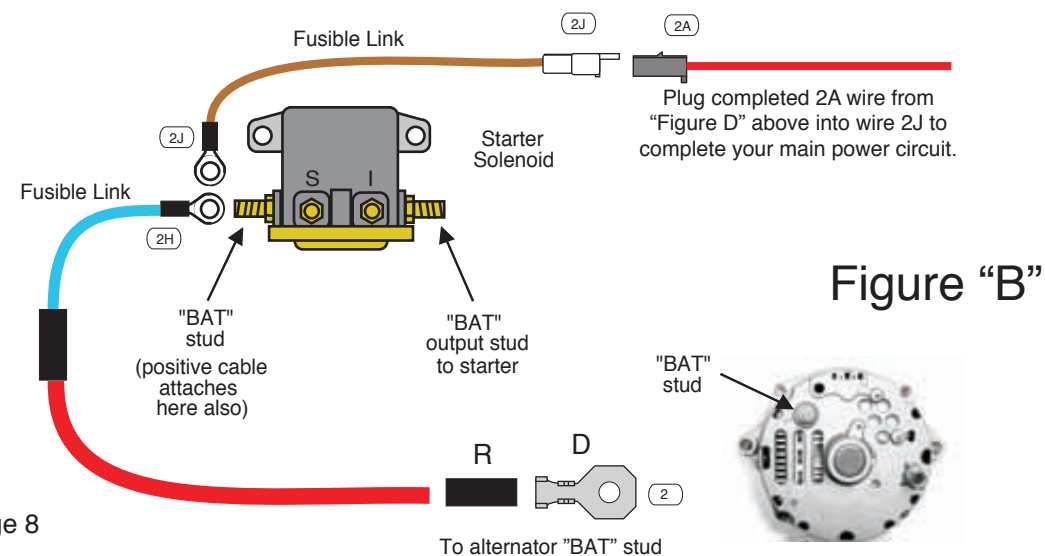
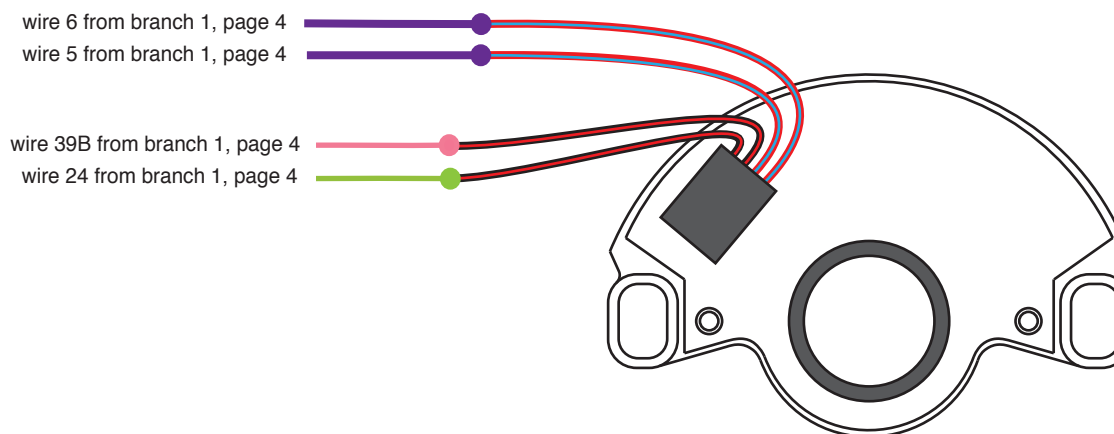

Figure "B"

Figure "C"

Shown is a typical NSS and Back Up Switch.



www.americanautowire.com 856-933-0801

PART # **510177**

DESCRIPTION:
1969-70 Mustang Classic Update Series Kit