

Classic Update Series

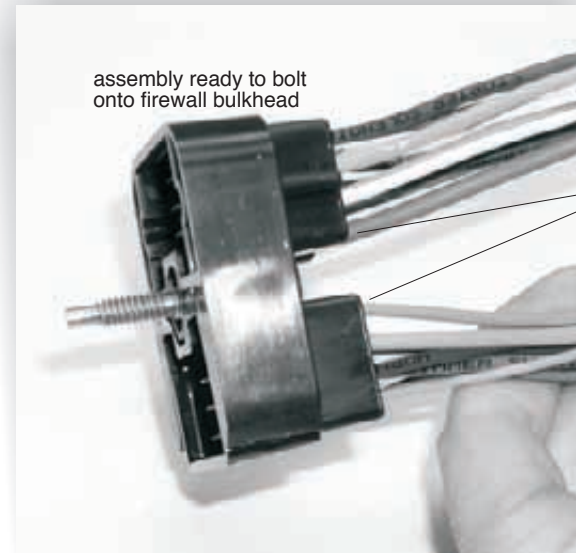
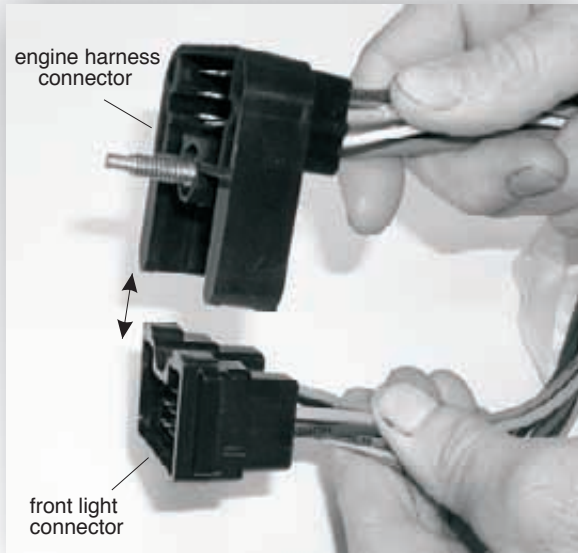

apply silicone sealant to back side of connector after installing terminals

The bulkhead connector from this front light kit must snap into the mating engine connector (bag J), as shown. After snapping together, then bolt the assembly into the dash harness firewall connector using the attached bolt.

Look!



**American
Autowire**

www.americanautowire.com 856-933-0801

American Autowire also sells factory OEM style harness wrap tape. This is the same stuff used on original GM harnesses! If you want that OEM look with your Classic Update wiring system, then give us a call and order our P/N R0067108!



Classic Update Series

right headlights

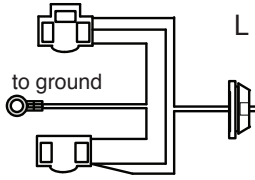

right H/L connection

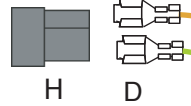
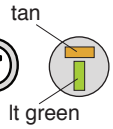

left headlights

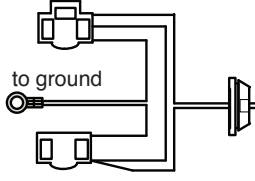

left H/L connection

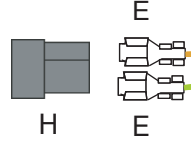
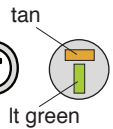

right turn signal

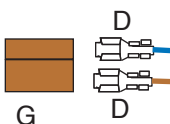
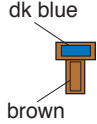

left turn signal

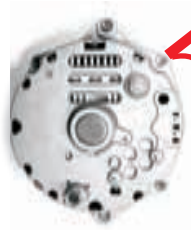
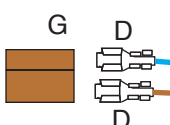
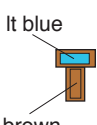

alternator

to electric fan

orange



recommended fan relay (not included in this kit)

to horn

K

E

dk green

to horn

K

D

lt green

tan

bulkhead connector

connect to brake pressure sending unit if needed (not included in kit)

tan

dk blue

brown

lt blue

brown

brown

apply silicone sealant to back side of connector after installing terminals

1959 Impala Front Light

1959 IMPALA

Snap together the bulkhead connector from this kit and the bulkhead connector from the engine kit (bag J) then bolt them to the firewall dash bulkhead. After all wires are installed from this kit, the main connector should have die-electric grease applied to the terminals and silicone sealer applied to the outside of the connectors as a moisture seal.



D

PARKING LAMP WIRES:

LT BLUE LH turn

Route this wire to the LH turn signal lamp connection in the LH inner fender panel, cut to length, install terminal D and plug into connector G in the location shown on sheet 2.



E

DK BLUE RH turn

Route this wire to the RH turn signal lamp connection in the RH inner fender panel, cut to length, install terminal D and plug into connector G in the location shown on sheet 2.

BROWN Parking Lamp

Route the shorter brown wire that is the same length as the light blue wire to the LH turn signal lamp connection in the LH inner fender panel, cut to length, install terminal D and plug into connector G in the location shown on sheet 2. Route the longer brown wire that is the same length as the dark blue wire to the RH turn signal lamp connection in the RH inner fender panel, cut to length, install terminal D and plug into connector G in the location shown on sheet 2.



G

FRONT LIGHT WIRING:



H

All 59 Chevrolet models utilized a special headlamp bucket harness assembly. You will find 2 of these harness assemblies L in your front lighting kit. Install them thru your factory headlight buckets, ground them to the inside of the bucket assembly as original using the provided ring terminal, and install the molded end into the LH and RH inner fender panels. The following front light connections that you are about to create will plug into these molded ends at the inner fender panels completing the headlamp connections.



K

TAN (heavy gauge) Lo Beam

Route this wire to the driver side LH headlight connection in the LH inner fender panel, cut to length, double this wire with the cutoff portion, install terminal E, and plug this terminal into connector H in the location shown on sheet 2. Route the remaining portion of this TAN wire to the passenger side RH headlight connection in the RH inner fender panel, cut to length, install terminal D, and plug this terminal into connector H in the location shown on sheet 2.

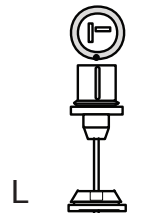

L

LT GREEN Hi Beam

Route this wire to the driver side LH headlight connection in the LH inner fender panel, cut to length, double this wire with the cutoff portion, install terminal E, and plug this terminal into connector H in the location shown on sheet 2. Route the remaining portion of this LT GREEN wire to the passenger side RH headlight connection in the RH inner fender panel, cut to length, install terminal D, and plug this terminal into connector H in the location shown on sheet 2.

OTHER WIRING:

DK GREEN Horn

Route to horns, cut to length, install terminals D & E, and plug into connectors L as shown on sheet 2.

ORANGE Electric Fan

Route to electric fan or relay and connect per the manufacturer's instructions.

NOTE: We recommend that this wire be used as the trigger wire only for the electric fan relay.

TAN (small gauge) Brake Light/ Switch

If your car is equipped with a brake warning system, plug this wire into the main connector as shown on sheet 2 and splice the other end onto your brake sender switch connection (brake switch connection not included in kit).

BROWN Alternator Regulator

Route this wire to the alternator and cut to length. Install terminal D and plug into the regulator connector (previously installed from the engine kit 510066 bag J) as shown on sheet 2. (Not used with 1 wire alternator)

Classic Update Series

right headlights

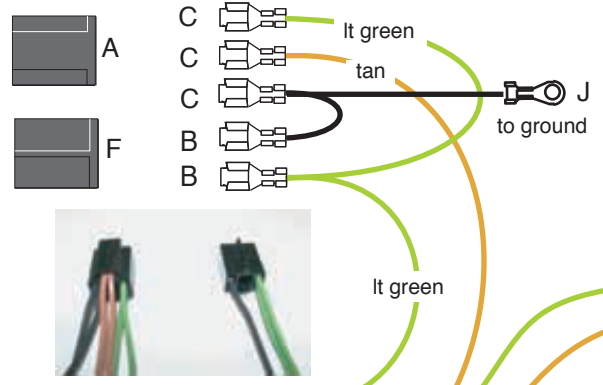

left headlights

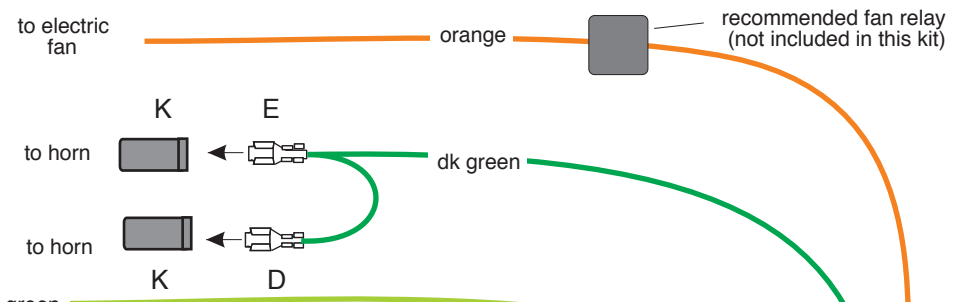
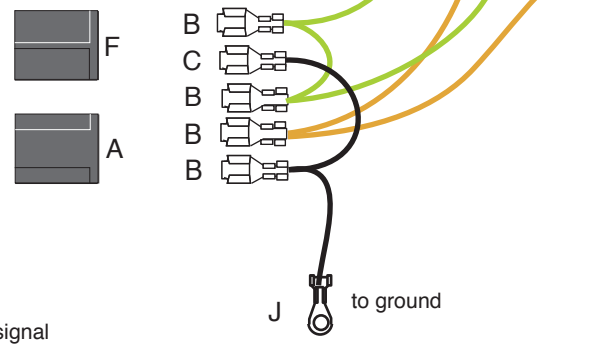

connect to brake pressure sending unit if needed (not included in kit)

right turn signal

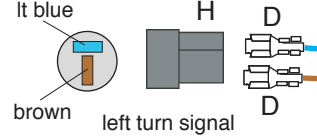
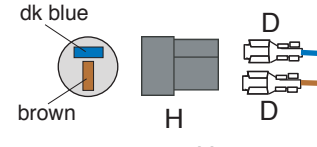

existing red wires from engine kit bag J

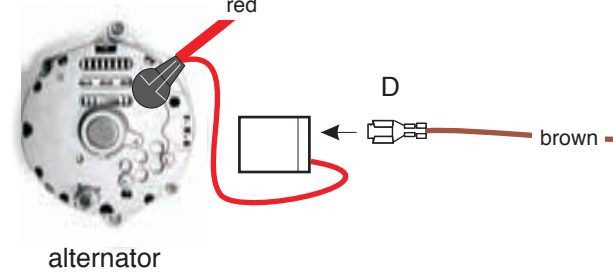

apply silicone sealant to back side of connector after installing terminals

1960 Impala Front Light

1960 IMPALA

Snap together the bulkhead connector from this kit and the bulkhead connector from the engine kit (bag J) then bolt them to the firewall dash bulkhead. After all wires are installed from this kit, the main connector should have die-electric grease applied to the terminals and silicone sealer applied to the outside of the connectors as a moisture seal.



PARKING LAMP WIRES:

LT BLUE	LH turn
DK BLUE	RH turn
BROWN	Parking Lamp

Route this wire to the LH turn signal lamp connection in the LH inner fender panel, cut to length, install terminal D and plug into connector G in the location shown on sheet 4.

Route this wire to the RH turn signal lamp connection in the RH inner fender panel, cut to length, install terminal D and plug into connector G in the location shown on sheet 4.

Route the shorter brown wire that is the same length as the light blue wire to the LH turn signal lamp connection in the LH inner fender panel, cut to length, install terminal D and plug into connector G in the location shown on sheet 4. Route the longer brown wire that is the same length as the dark blue wire to the RH turn signal lamp connection in the RH inner fender panel, cut to length, install terminal D and plug into connector G in the location shown on sheet 4.

FRONT LIGHT WIRING:

TAN (heavy gauge)	Lo Beam
LT GREEN	Hi Beam

Route this wire to the driver side outer headlight, trim to length, double this wire with the cutoff portion, install terminal B and plug into connector A in the location shown on sheet 4. Route the remaining portion of this TAN wire to the passenger side outer headlight, trim to length, install terminal C and plug into connector A as shown on sheet 4.

Route this wire to the driver side outer headlight, trim to length, double this wire with the cutoff portion, install terminal B, plug this terminal into connector A, make a short jumper over to the driver side inner headlight, cut to length, double it with the cutoff portion, install terminal B, and plug it into connector F in the location shown on sheet 4. Route the remaining portion of this LT GREEN wire to the passenger side inner headlight, trim to length, double this wire with the cutoff portion, install terminal B, plug into connector F, make a short jumper over to the passenger side outer headlight, cut to length, double it with the cutoff portion, install terminal C, and plug it into connector A in the location shown on sheet 4.

BLACK	Ground
-------	--------

Attach the ring terminal to a good chassis ground then route this wire to the driver side outer headlight, trim to length, double this wire with the cutoff portion, install terminal B and plug this terminal into connector A. Route the remaining portion of this BLACK wire over to the driver side inner headlight, cut to length, install terminal C, and plug it into connector F in the location shown on sheet 4. Repeat this process for the passenger side.

OTHER WIRING:

DK GREEN	Horn
ORANGE	Electric Fan
TAN (small gauge)	Brake Light/ Switch
BROWN	Alternator Regulator

Route to horns, cut to length, install terminals D & E, and lug into connectors L as shown on sheet 4.

Route to electric fan or relay and connect per the manufacturer's instructions.

NOTE: We recommend that this wire be used as the trigger wire only for the electric fan relay.

If your car is equipped with a brake warning system, plug this wire into the main connector as shown on sheet 4 and splice the other end onto your brake sender switch connection **(brake switch connection not included in kit)**.

Route this wire to the alternator and cut to length. Install terminal D and plug into the regulator connector (previously installed from the engine kit 510066 bag J) as shown on sheet 2. (Not used with 1 wire alternator)

This page intentionally left blank