

1967 Installation Instructions - Manual Transmission Cars

STOP:

This kit is intended for the modification of the existing dash, engine, and front light harnesses for a manual transmission car that was not **“originally”** equipped with the console gauge option. If your vehicle is not an **“original”** manual column shift car or an **“original”** manual shift car with or without a stock factory console, this kit is incorrect for your vehicle and will not work in your vehicle. If you are unsure of the original configuration of your vehicle or are completely re-configuring your vehicle, American Autowire suggests that you purchase a complete set of Factory-Fit replacement harnesses that can be tailored to the final configuration desired for your vehicle.

The instructions provide a step by step procedure to add the dash harness wiring extension necessary to plug into the console gauge harness in order to complete the wiring circuits necessary to operate the console gauge package option. To complete the wiring it is also necessary to modify both the engine and front light harnesses. Wires and instructions for this modification are also included in this kit. This kit does not include the console gauge harness. It will be necessary to purchase part number CA70657 if your console gauge package does not already have an existing console gauge harness.

Please refer to the pictorial view of the harness on page 3 and the connector diagrams on page 4 for a detailed view of the connector cavity indexing. These drawings will be referenced throughout the installation of this kit. The drawings on page 4 show the wire colors in the connector cavities as they appear before starting the conversion and after completing the conversion.

DASH SIDE MODIFICATIONS

AMMETER GAUGE - 1967

1. Connect the black wire from the Console Gauge Extension Harness Connector location 7 to fuse block bulkhead connector location E-X. (see wire 105A on page 3).
2. Connect the black/white wire from the Console Gauge Extension Harness Connector location 8 to fuse block bulkhead connector location E-W. (see wire 106A on page 3).

FUEL GAUGE - 1967

1. Unplug the instrument cluster connector from the rear on the instrument cluster. The connector is numbered above each cavity.
2. Location 1 contains a tan wire. Remove the terminal and wire from the cluster connector. This wire will be eliminated from the circuit when you are complete. But for now, it should be taped out of the way.
This step is necessary as this cavity will be reused by the tachometer connection that will be made in later steps.
3. Disconnect the rear body harness from the dash harness. Remove the tan wire from the dash side of the rear body connector and tape it aside.
4. Replace this tan wire with the tan wire from location 12 of the Console Gauge Extension Harness Connector. (see wire 30 on page 3).
5. Reconnect the rear body harness to the dash harness. This now routes the fuel sender wiring directly to the console mounted fuel gauge.

OIL PRESSURE GAUGE - 1967

Oil pressure gauges are mechanical and require an oil line to be connected from the back of the oil pressure gauge to a fitting in the engine block where the original electrical sender was mounted.

This fitting replaces the oil pressure warning light sender. Electrical modifications for the oil pressure gauge are necessary to remove the warning light circuit as follows:

1. Unplug the instrument cluster connector from the rear on the instrument cluster. The connector is numbered above each cavity.
2. Location 8 contains blue/white wire. Remove the terminal and wire from the cluster connector. This wire will be eliminated from the circuit when you are complete. But for now, it should be taped out of the way.
3. Trace this wire to the fuse block bulkhead connector and remove the terminal and wire from location D-Z. This now removes the original oil pressure warning light circuit from service.
This step is necessary as this cavity will be reused by the tachometer connection that will be made in later steps.

TEMPERATURE GAUGE - 1967

1. Unplug the instrument cluster connector from the rear on the instrument cluster. The connector is numbered above each cavity.
2. Location 2 contains two dark green wires. Remove the terminal and wires from the cluster connector. This wire will be eliminated from the circuit when you are complete, but for now it should be taped out of the way.
3. Originally, one of these wires was routed to the fuse block bulkhead connector and the other to the ignition switch.
4. Trace the wire to the fuse block bulkhead connector and remove the terminal and wire from location C-Z.
5. Trace the wire to the ignition switch and disconnect the terminal and wire from the ignition switch. This now removes the original dash mounted temperature warning light circuit from service as it is no longer used.
6. Connect the dark green wire from location 11 of the Console Gauge Extension Harness Connector to fuse block bulkhead connector location C-Z. (see wire 35A on page 3).
This now routes the temperature sender lead wire directly from the fuse block bulkhead connector to the gauge harness connector. Note that a new temperature sender is necessary for the temperature gauge versus the one used for warning lights.

LOW FUEL INDICATOR LIGHT - 1967

1. The light connected to the yellow wire from location 2 of the Console Gauge Extension Harness Connector must be plugged directly into the speedometer cluster chassis in the hole underneath the mylar circuit board in the low fuel light position. (see wire 952 on page 3).
2. **Special Note.** Be sure the low fuel indicator unit you are using is designed for a 1967 Camaro. Units designed for a 1968-69 Camaro function differently and will not work in 1967 vehicles.



CA6705

CONSOLE GAUGE CONVERSION HARNESS 1967 CAMARO MANUAL TRANSMISSION

©1986,1990,1993, 2010
American Autowire
all rights reserved

Information and illustrations on this instruction sheet are the property of American Autowire, Inc. No part of this sheet may be reproduced without licensing approval from American Autowire, Inc.

American Autowire -150 Heller Place #17 W - Bellmawr, N.J. 08031 - 856-933-0801

92969726 INSTRUCTION SHEET

REV 1.0 12/30/2010

CONSOLE COURTESY LIGHT - 1967

Select the white wire originating from location 5 of the Console Gauge Extension Harness Connector. This wire is used for the courtesy light at the rear of a stock console. Connect as follows:

1. Remove the white wire from the headlight switch connector.
2. Plug the white wire from location 5 of the Console Gauge Extension Harness Connector into the same headlight switch cavity that the original white wire was removed from. (see wire 156 on page 3).
3. Plug the original white wire removed from the headlight switch connector into the white pigtail jumper wire using the supplied locking connector body. This now activates the console courtesy light circuit.

POWER CONNECTIONS - 1967

There may be existing connections plugged into the fuse box to accommodate accessories requiring battery power, ignition power, and instrument lights. When plugging in the following connections, the existing connections should first be unplugged from the fuse block and plugged into the pigtail lead attached to each of the battery, ignition, and instrument light wires defined in the following instructions.

1. Plug the orange wire from location 1 of the Console Gauge Extension Harness Connector to a constant battery power terminal on the front of the fuse panel. (see wire 140 on page 3). If your vehicle was an original floor shift manual transmission car with a factory console, the courtesy light at the rear of the console was connected to a white and orange wire jumper harness that plugged into a "T" shaped connector under the dash. This jumper harness should be unplugged from the dash harness and removed as it will no longer be used. For console gauge equipped cars, the rear mounted console courtesy light is connected to the console harness that came with your gauge package or to the CA70657 console gauge harness available from American Autowire.
2. Plug the pink wire from location 9 of the Console Gauge Extension Harness Connector to an ignition power terminal on the front of the fuse panel. (see wire 39 on page 3).
3. Plug the gray wire from location 10 of the Console Gauge Extension Harness Connector to the instrument light terminal on the front of the fuse panel. (see wire 8 on page 3).

GENERATOR WARNING LIGHT - 1967

1. Unplug the speedometer cluster connector from the rear of the instrument cluster. The connector is numbered above each cavity.
2. Disconnect the brown wire from the speedometer cluster connector location 11 and tape the end to prevent grounding. This wire was originally used for the "GEN" warning light which is not used in the instrument cluster for console gauge equipped cars.

TACHOMETER - 1967

1. Unplug the instrument cluster connector from the rear on the instrument cluster. The connector is numbered above each cavity.
2. Insert the cluster connector terminal end of the brown wire taped into the gauge extension harness into location 1 of the instrument cluster connector. (see wire 121A on page 3 at the center of the harness with wires 952, 30, and 156).
3. Insert the other end of this wire into the fuse block bulkhead connector location D-Z. (see wire 121A on page 3 at the far right hand side of the harness).

ENGINE SIDE MODIFICATIONS

AMMETER GAUGE - 1967

1. Select the long black wire with the orange fusible link and connect the fusible link end to the positive battery junction block located behind the battery.
Connect the other end of this wire into location E-X of the front light harness connector. (see wire 105B on page 3).
2. Select the long black/white wire with the orange fusible link and connect the fusible link end to one of the positive battery screws on the horn relay.
Connect the other end of this wire into location E-W of the front light harness connector. (see wire 106B on page 3).

FUEL GAUGE - 1967

No electrical modifications are necessary.

GENERATOR WARNING LIGHT - 1967

No electrical modifications are necessary.

OIL PRESSURE GAUGE - 1967

Oil pressure gauges are mechanical and require an oil line to be connected from the back of the oil pressure gauge to a fitting in the engine block where the original electrical sender was mounted. This fitting replaces the oil pressure warning light sender. After the old sending unit is replaced by a mechanical fitting and line, the blue wire originally connected to the sending unit must be disconnected from the engine harness fuse block connector at location D-Z as follows:

1. Remove the twin lock terminal from the engine harness connector location D-Z and cut off the terminal.
2. Disconnect the blue wire from the old sending unit, cut off the terminal, and pull the wire through the harness and discard it.

TEMPERATURE GAUGE - 1967

1. Select the dark green temperature sender wire with the loom covering. (see wire 35B on page 3).
2. Remove the existing dark green wire from location C-Z of the engine harness connector and replace it with the new dark green wire with the twin lock terminal end to location C-Z of the engine harness connector.
3. Connect the other end with the sender connector to the temperature sender. All warning light and gauge equipped cars used the same wiring to the temperature sending unit. The difference in the sending units is in the function of the sending unit and the connector to the sending unit, not the wiring. The warning light sending unit must be replaced with a sending unit for gauges. Original GM sending units for gauge equipped cars are recommended, however, replacement units are made by many after market component suppliers. American Autowire can supply this sender under part number 01513321.

TACHOMETER - 1967

1. Select the brown wire with the right angle spade terminal on one end and a twin lock terminal on the other end. (see wire 121B on page 3).
2. Connect the twin lock terminal end to location D-Z of the engine harness connector.
3. Connect the right angle spade terminal end to the distributor (-) side of the ignition coil.

CONSOLE GAUGE DASH HARNESS EXTENSION

Dash Side Connections

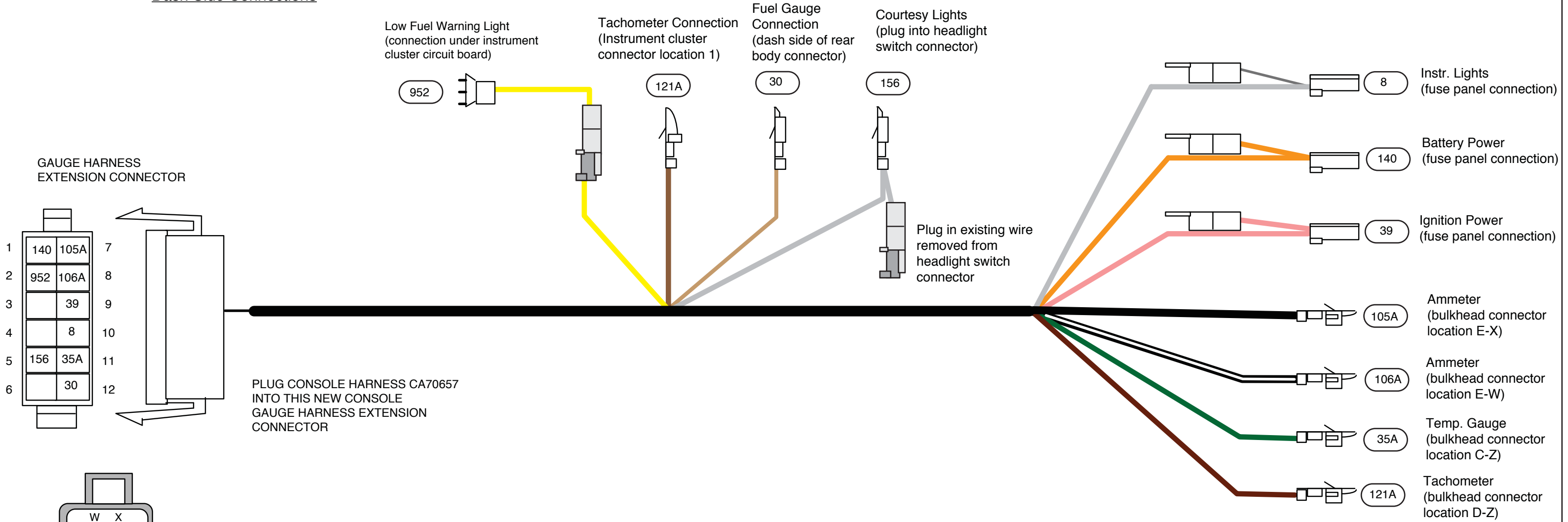

Engine Side Connections

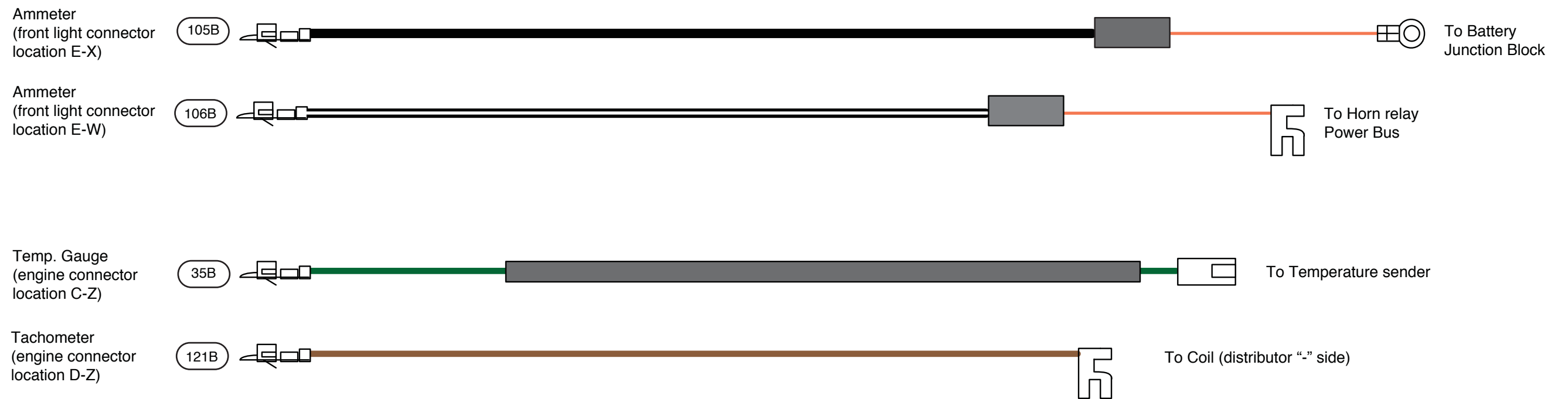
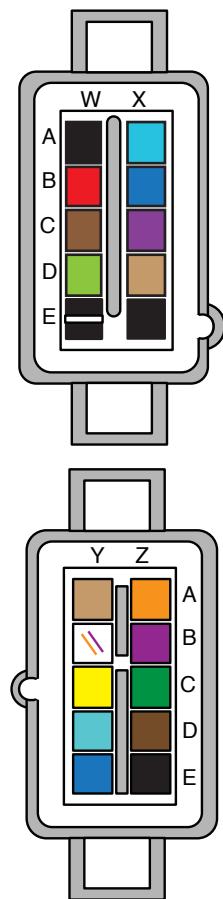

BEFORE CONVERSION

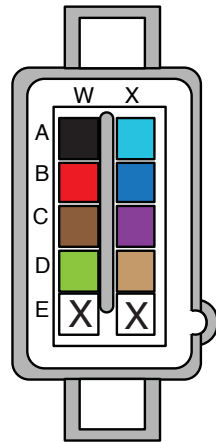

1967 FRONT LIGHT HARNESS CONNECTOR (viewed from terminal side opposite of the wire entry)

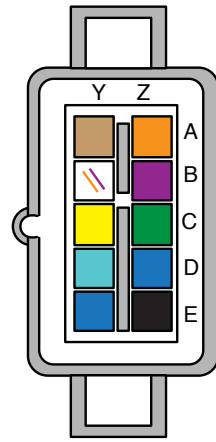

1967 ENGINE HARNESS CONNECTOR (viewed from terminal side opposite of the wire entry)

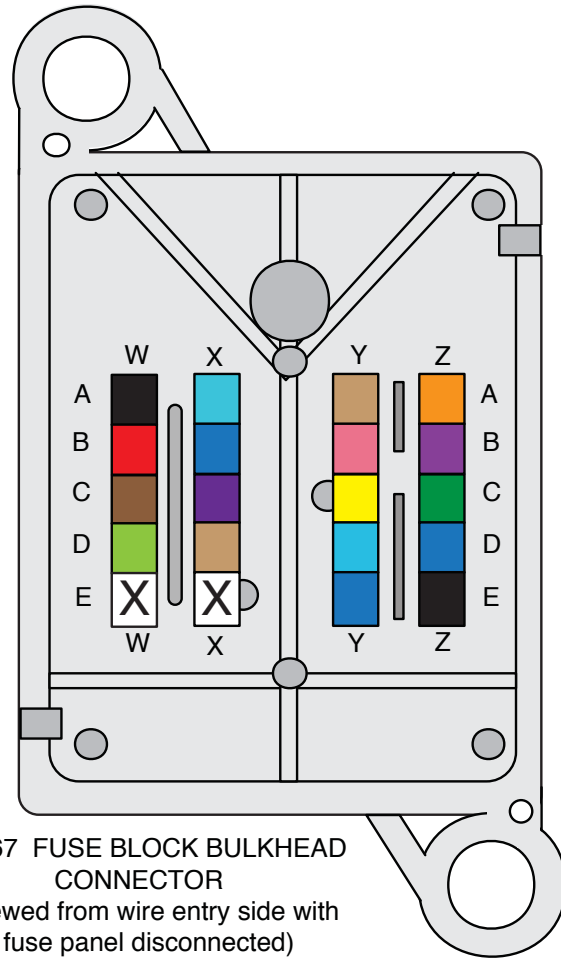

1967 FUSE BLOCK BULKHEAD CONNECTOR (viewed from wire entry side with the fuse panel disconnected)

1967 INSTRUMENT CLUSTER CONNECTOR (viewed from terminal side opposite of the wire entry)

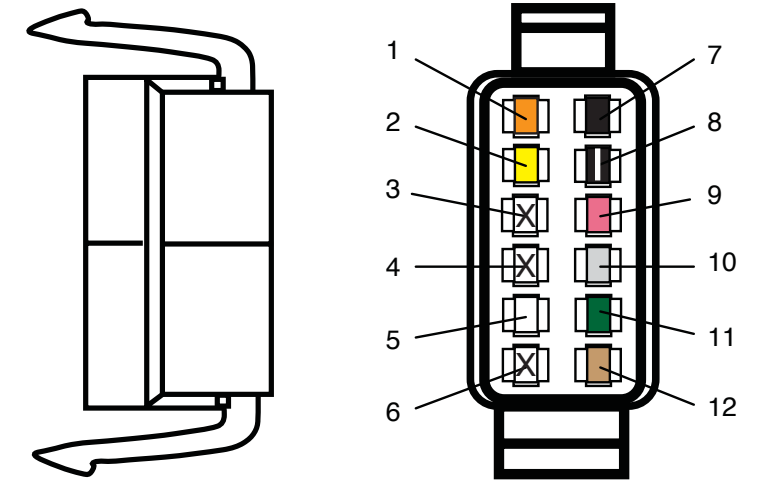
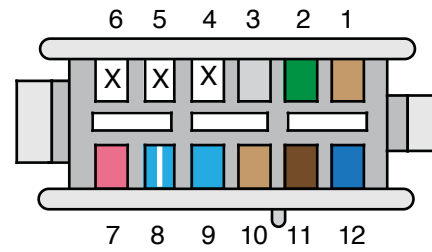

GAUGE HARNESS CONNECTOR SUPPLIED ON THE CONSOLE EXTENSION HARNESS (viewed from the terminal side opposite of the wire entry)

CONSOLE WIRING APPLICATION CHART		
wire	color	application
1	orange	Rear console light
1	orange	1967 gauge cluster clock
2	yellow	Low fuel indicator lamp
3	purple	Neutral safety switch (automatic only)
4	purple/wht stripe	Neutral safety switch (automatic only)
5	white	Rear console light
6	light green	Neutral safety switch - backup light (automatic only)
7	black	Ammeter gauge
8	black/wht stripe	Ammeter gauge
9	pink	Neutral safety switch - backup light power (automatic only)
10	pink	Fuel and temperature gauge power
11	gray	Gauge lamps
11	dark green	Temperature gauge
12	tan	Fuel gauge
12	black	console gauge cluster ground

AFTER CONVERSION

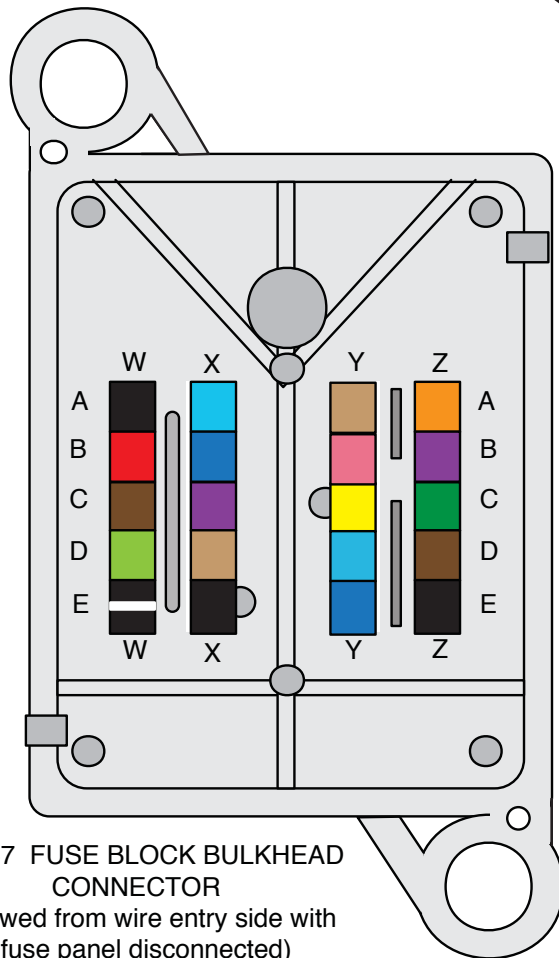

1967 FUSE BLOCK BULKHEAD CONNECTOR (viewed from wire entry side with the fuse panel disconnected)

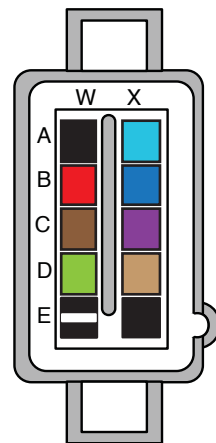

1967 FRONT LIGHT HARNESS CONNECTOR (viewed from terminal side opposite of the wire entry)

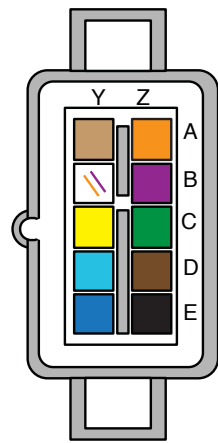

1967 ENGINE HARNESS CONNECTOR (viewed from terminal side opposite of the wire entry)

1967 INSTRUMENT CLUSTER CONNECTOR (viewed from terminal side opposite of the wire entry)

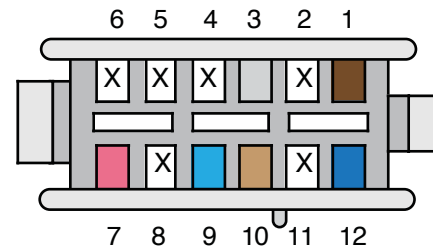

CONSOLE GAUGE CONVERSION ILLUSTRATIONS

©1986,1990,1993, 2010 American Autowire all rights reserved

Information and illustrations on this instruction sheet are the property of American Autowire, Inc. No part of this sheet may be reproduced without licensing approval from American Autowire, Inc.

American Autowire -150 Heller Place #17 W - Bellmawr, N.J. 08031 - 856-933-0801