

1969 Installation Instructions - Manual transmission cars

STOP:

This kit is intended for the modification of the existing dash, engine, and front light harnesses for a manual transmission car that was not “*originally*” equipped with the console gauge option. If your vehicle is not an “*original*” manual column shift car or an “*original*” manual floor shift car with or without a factory console, this kit is incorrect for your vehicle and will not work in your vehicle. If you are unsure of the original configuration of your vehicle or are completely re-configuring your vehicle, American Autowire suggests that you purchase a complete set of Factory-Fit replacement harnesses that can be tailored to the final configuration desired for your vehicle.

The instructions provide a step by step procedure to add the dash harness wiring extension necessary to plug into the console gauge harness in order to complete the wiring circuits necessary to operate the console gauge package option. To complete the wiring it is also necessary to modify both the engine and front light harnesses. Wires and instructions for this modification are also included in this kit. This kit does not include the console gauge harness. It will be necessary to purchase part number CA97581 if your console gauge package does not already have an existing console gauge harness.

Please refer to the pictorial view of the harness on page 3 and the connector diagrams on page 4 for a detailed view of the connector cavity indexing. These drawings will be referenced throughout the installation of this kit. The drawings on page 4 show the wire colors in the connector cavities as they appear before starting the conversion and after completing the conversion.

DASH SIDE MODIFICATIONS

AMMETER GAUGE - 1969

1. Connect the black wire from the Console Gauge Harness Extension Connector location 7 to the fuse block bulkhead connector location S-A. (see wire 105A on page 3).
2. Connect the black/white wire from the Console Gauge Harness Extension Connector location 8 to the fuse block bulkhead connector location S-B. (see wire 106A on page 3).

FUEL GAUGE - 1969

1. Unplug the connector from the back of the dash mounted fuel gauge.
2. Remove the tan wire and terminal from the connector and connect it to the tan wire from location 12 of the Console Gauge Harness Extension Connector using the supplied locking connector body. (see wire 30 on page 3). This now routes the fuel sender wiring directly to the console mounted fuel gauge.

OIL PRESSURE GAUGE - 1969

Oil pressure gauges are mechanical and require an oil line to be connected from the back of the oil pressure gauge to a fitting in the engine block where the original electrical sender was mounted. This fitting replaces the oil pressure warning light sender. No electrical modifications for the oil pressure gauge are necessary to the dash harness. Simply remove the oil pressure warning light bulb located in the right hand warning light pod.

TEMPERATURE GAUGE - 1969

1. Locate the two dark green wires going into the temperature warning light (second light from the left in the warning light assembly located to the right of the steering column).
2. Remove the terminal and these wires from the light socket and tape them aside.
3. Originally, one of these wires was routed to the fuse block bulkhead connector and the other to the ignition switch.
4. Trace the wire to the fuse block bulkhead connector and remove the terminal and wire from location C-T.
3. Trace the wire to the ignition switch and remove the terminal and wire from the ignition switch. This now removes the original dash mounted temperature warning light circuit from service.
5. Connect the dark green wire from location 11 of the Console Gauge Harness Extension Connector to the fuse block bulkhead connector location C-T. (see wire 35A on page 3). This now routes the temperature sender lead wire directly from the fuse block bulkhead connector to the gauge harness connector. Note that a new temperature sender is necessary for the temperature gauge versus the one used for warning lights. American Autowire can supply the correct sender under part number 01513462.

LOW FUEL INDICATOR LIGHT - 1969

1. The low fuel indicator light occupies the light socket position next to the left turn signal indicator. Normally, this socket is empty for non gauge (warning light) equipped cars. There are two wires from the Console Gauge Extension harness that are used to wire the low fuel indicator circuit.
2. Plug the yellow wire with the wedge base bulb terminal from location 2 of the Console Gauge Harness Extension Connector into one of the low fuel light lamp socket terminal holders. (see wire 952 on page 3).
3. Plug the pink wire with the wedge base bulb terminal from location 9 of the Console Gauge Harness Extension Connector into the other low fuel light lamp socket terminal holder. (see wire 39C on page 3).
4. **Special Note.** Be sure the low fuel indicator unit you are using is designed for a 1968-69 Camaro. Units designed for a 1968-69 Camaro function differently from those used in the 1967 Camaro. Low fuel indicators used for the 1967 Camaro will not work in 1969 vehicles.



CA6905

CONSOLE GAUGE CONVERSION HARNESS 1969 CAMARO MANUAL TRANSMISSION

©1986,1990,1993, 2010
American Autowire
all rights reserved

Information and illustrations on this instruction sheet are the property of American Autowire, Inc. No part of this sheet may be reproduced without licensing approval from American Autowire, Inc.

American Autowire -150 Heller Place #17 W - Bellmawr, N.J. 08031 - 856-933-0801

92969732 INSTRUCTION SHEET

REV 1.0 12/30/2010

CONSOLE COURTESY LIGHT - 1969

Select the white wire originating from location 5 of the gauge harness connector. This wire is used for the courtesy light at the rear of a stock console. Connect as follows:

1. Remove the white wire from the headlight switch connector.
2. Plug the white wire from location 5 of the Console Gauge Harness Extension Connector into the same headlight switch cavity that the original white wire was removed from. (see wire 156 on page 3).
3. Plug the original white wire removed from the headlight switch connector into the white pigtail jumper wire using the supplied locking connector body. This now activates the console courtesy light circuit.

POWER CONNECTIONS - 1969

There may be existing connections plugged into the fuse box to accommodate accessories requiring battery power, ignition power, and instrument lights. When plugging in the following connections, the existing connections should first be unplugged from the fuse block and plugged into the pigtail lead attached to each of the battery, ignition, and instrument light wires defined in the following instructions.

1. Plug the orange wire from location 1 of the gauge harness connector to a constant battery power terminal on the front of the fuse panel. (see wire 140 on page 3). If your vehicle was an original floor shift manual transmission car with a factory console, the courtesy light at the rear of the console was connected to a white and orange wire jumper harness that plugged into a "T" shaped connector under the dash. This jumper harness can be unplugged from the dash harness and removed. For console gauge equipped cars, the rear mounted console courtesy light is connected to the console harness that came with your gauge package or to the CA97581 console gauge harness available from American Autowire.
2. Plug the pink wire from location 9 of the Console Gauge Harness Extension Connector to an ignition power terminal on the front of the fuse panel. (see wire 39A on page 3).
3. Plug the gray wire from location 10 of the Console Gauge Harness Extension Connector to the instrument light terminal on the front of the fuse panel. (see wire 8 on page 3).

GENERATOR WARNING LIGHT - 1969

No electrical modifications are necessary to the dash harness. Simply remove the generator light bulb from the generator warning lamp location in the right hand warning light pod.

TACHOMETER - 1969

The tachometer connector is already wired into the gauge extension harness and is connected as follows:

1. Plug the three position connector with the brown, pink, and black wires into your tachometer.
2. Connect the black wire from the tachometer connector to a good ground.
3. Plug the brown wire from the tachometer connector into the fuse block bulkhead connector location A-X. (see wire 121A on page 3).

ENGINE SIDE MODIFICATIONS

AMMETER GAUGE - 1969

1. Select the long black wire with the orange fusible link and connect the fusible link end to the positive battery junction block located behind the battery.
Connect the other end of this wire into location S-A of the front light harness connector. (see wire 105B on page 3).
2. Select the long black/white wire with the orange fusible link and connect the fusible link end to one of the positive battery screws on the horn relay.
Connect the other end of this wire into location S-B of the front light harness connector. (see wire 106B on page 3).

FUEL GAUGE - 1969

No electrical modifications are necessary.

OIL PRESSURE GAUGE - 1969

Oil pressure gauges are mechanical and require an oil line to be connected from the back of the oil pressure gauge to a fitting in the engine block where the original electrical sender was mounted. This fitting replaces the oil pressure warning light sender.

After the old sending unit is replaced by a mechanical fitting and line, the blue wire originally connected to the sending unit must be disconnected from the engine harness fuse block connector at location B-Z as follows:

1. Remove the terminal and wire from the engine harness connector location B-Z and cut off the terminal.
2. Disconnect the blue wire from the old sending unit, cut off the terminal, and pull the wire through the harness and discard it.

TEMPERATURE GAUGE - 1969

1. Select the dark green temperature sender wire with the loom covering. (see wire 35B on page 3).
2. Remove the existing dark green wire from location T-C of the front light harness connector and replace it with the new dark green wire with the blade terminal end to location T-C of the front light harness connector.
3. Connect the other end with the sender connector to the temperature sender. All warning light and gauge equipped cars used the same wiring to the temperature sending unit. The difference is in the sending unit, the function of the sending unit, and the connector to the sending unit, not the wiring. The warning light sending unit must be replaced with a sending unit for gauges. Original GM sending units for gauge equipped cars are recommended, however, replacement units are made by many after market component suppliers. American Autowire can supply this sender under part number 01513462.

TACHOMETER - 1969

1. Select the brown wire with the right angle spade terminal on one end and a male terminal on the other end. (see wire 121B on page 3).
2. Connect the male terminal end to location A-X of the engine harness connector.
3. Connect the right angle spade terminal end to the distributor (-) side of the ignition coil.

CONSOLE GAUGE DASH HARNESS EXTENSION

Dash Side Connections

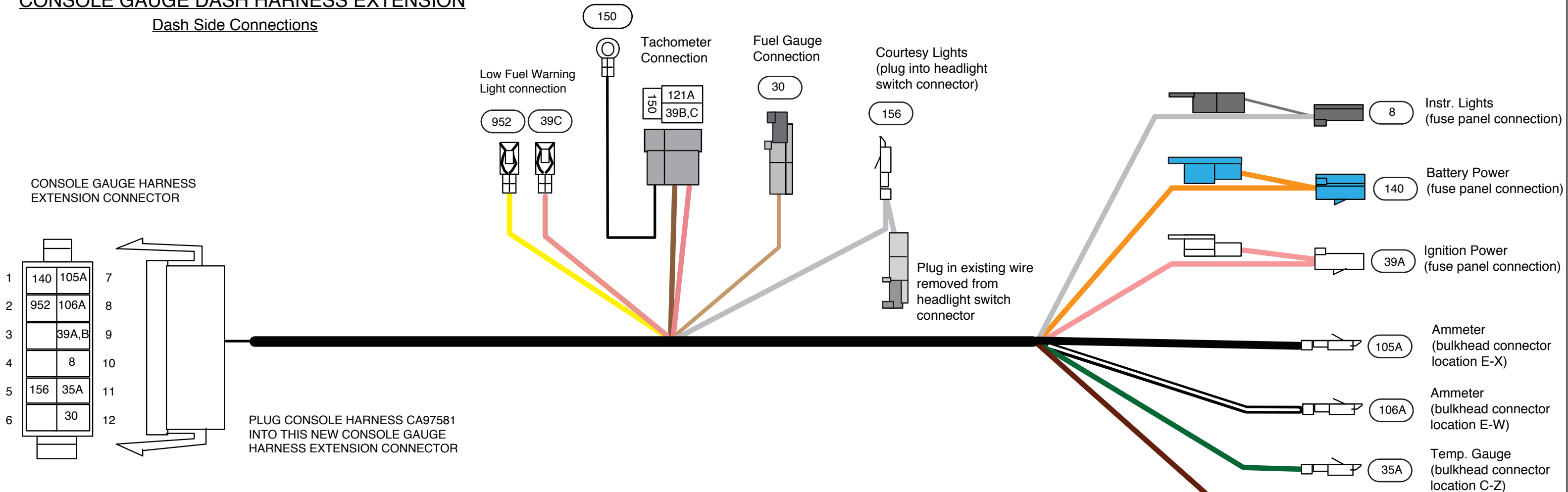

Engine Side Connections

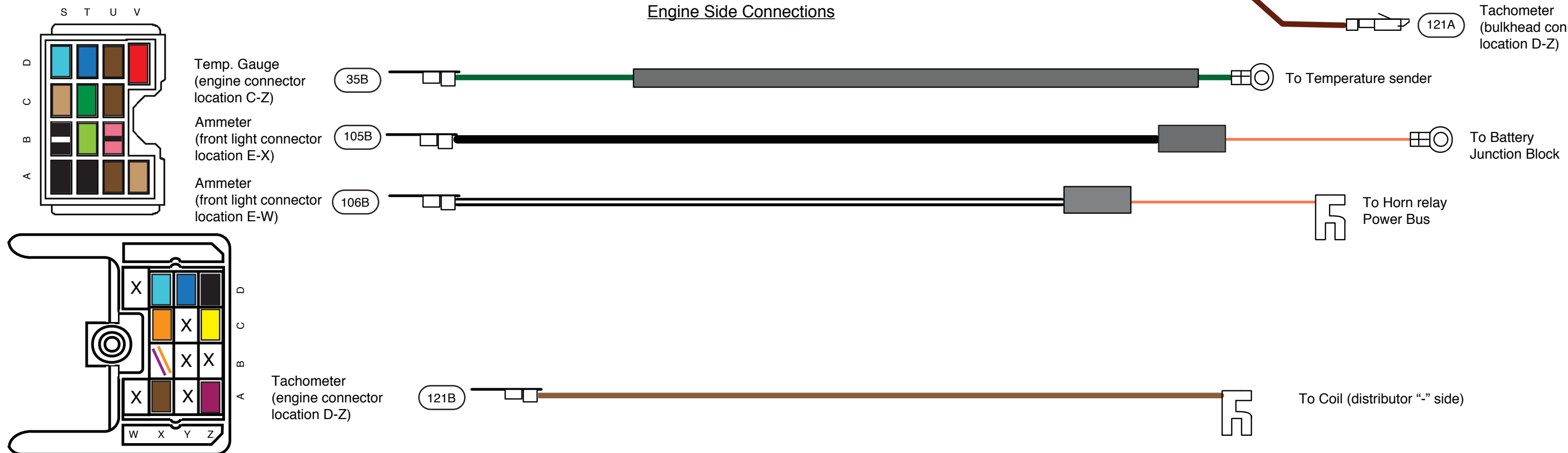

BEFORE CONVERSION

1968-69 FRONT LIGHT HARNESS CONNECTOR
(viewed from terminal side opposite of the wire entry)

1968-69 ENGINE HARNESS CONNECTOR
(viewed from terminal side opposite of the wire entry)

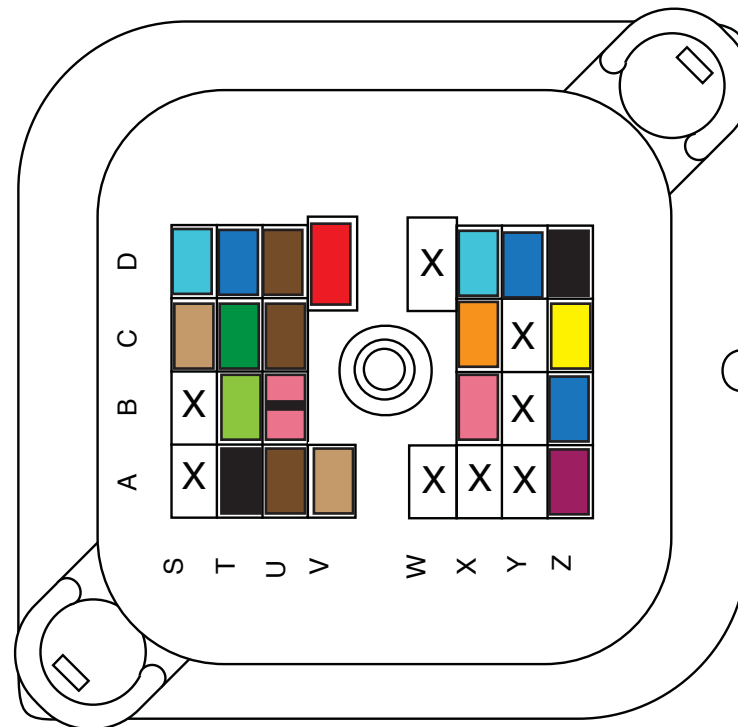
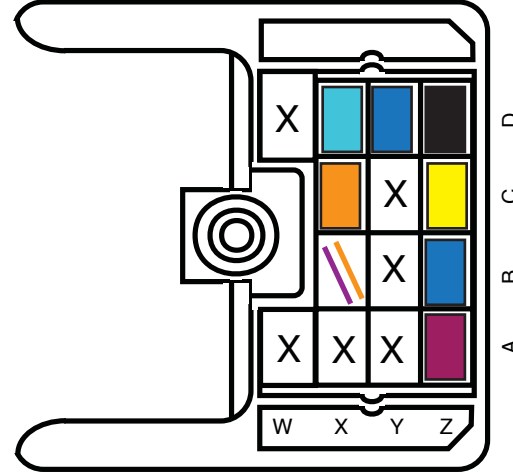
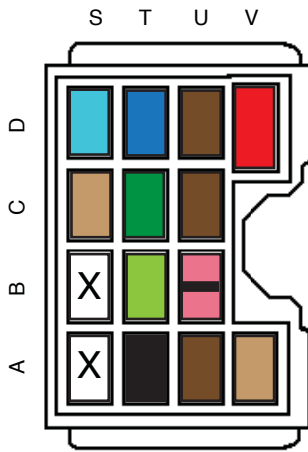

1968 - 1969 FUSE BLOCK BULKHEAD CONNECTOR
(viewed from wire entry side with the fuse panel disconnected)

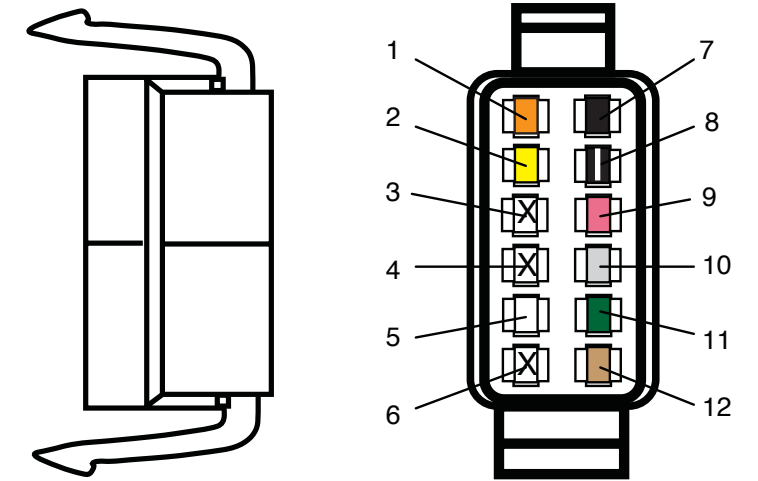

GAUGE HARNESS CONNECTOR
SUPPLIED ON THE CONSOLE EXTENSION HARNESS
(viewed from the terminal side opposite of the wire entry)

CONSOLE WIRING APPLICATION CHART		
wire	color	application
1	orange	Rear console light
2	yellow	Low fuel indicator lamp
3	purple	Neutral safety switch (automatic only)
4	purple/wht stripe	Neutral safety switch (automatic only)
5	white	Rear console light
6	light green	Neutral safety switch - backup light (automatic only)
7	black	Ammeter gauge
8	black/wht stripe	Ammeter gauge
9	pink	Neutral safety switch - backup light power (automatic only)
10	pink	Fuel and temperature gauge power
11	gray	Gauge lamps
12	dark green	Temperature gauge
	tan	Fuel gauge
	black	console gauge cluster ground

AFTER CONVERSION

1968-69 FRONT LIGHT HARNESS CONNECTOR
(viewed from terminal side opposite of the wire entry)

1968-69 ENGINE HARNESS CONNECTOR
(viewed from terminal side opposite of the wire entry)

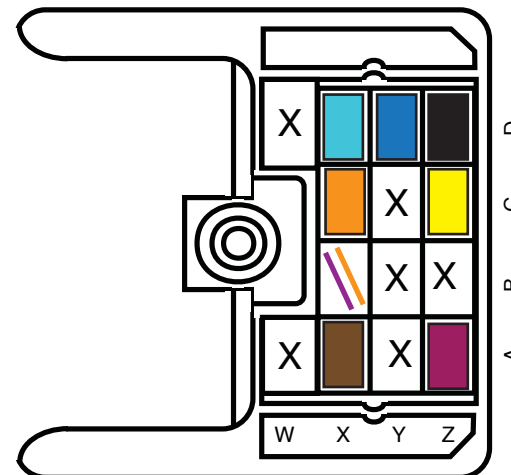
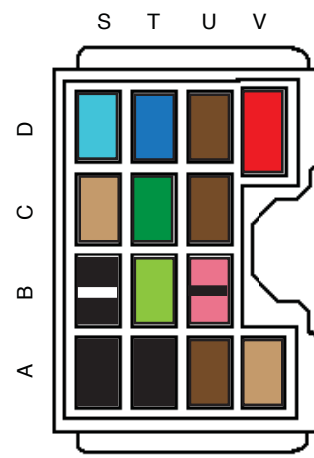
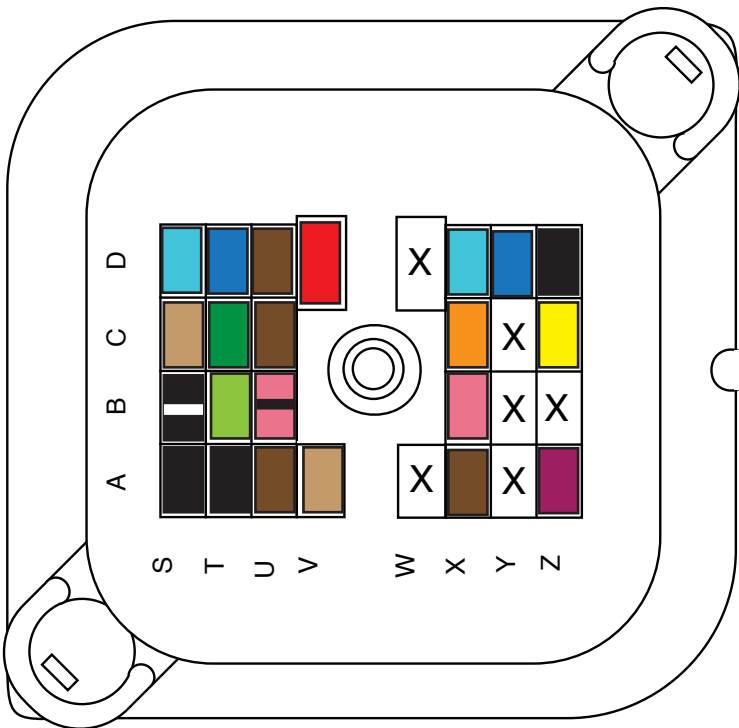

1968 - 1969 FUSE BLOCK BULKHEAD CONNECTOR
(viewed from wire entry side with the fuse panel disconnected)

CONSOLE GAUGE CONVERSION ILLUSTRATIONS

©1986,1990,1993, 2010
American Autowire
all rights reserved

Information and illustrations on this instruction sheet are the property of American Autowire, Inc. No part of this sheet may be reproduced without licensing approval from American Autowire, Inc.

American Autowire -150 Heller Place #17 W - Bellmawr, N.J. 08031 - 856-933-0801