

INSTALLING THE FUSE BOX

Fuse Panel Installation Instructions

Following these simple instructions will guarantee a successful installation of your "NEW" American Autowire fuse panel harness.

1. Study the diagram above to familiarize yourself with the dash harness assembly.
2. Modify your firewall and install the fuse box (see item #1 below right, and 92969921 template).
3. Route the harness in the original fashion using the factory support straps behind the dash.
4. Make all connections as shown on the following pages of this dash harness kit.
5. Once this dash harness has been installed, continue to bag "H" and install the remaining subkits in order (H, J, K, L, M, etc.)

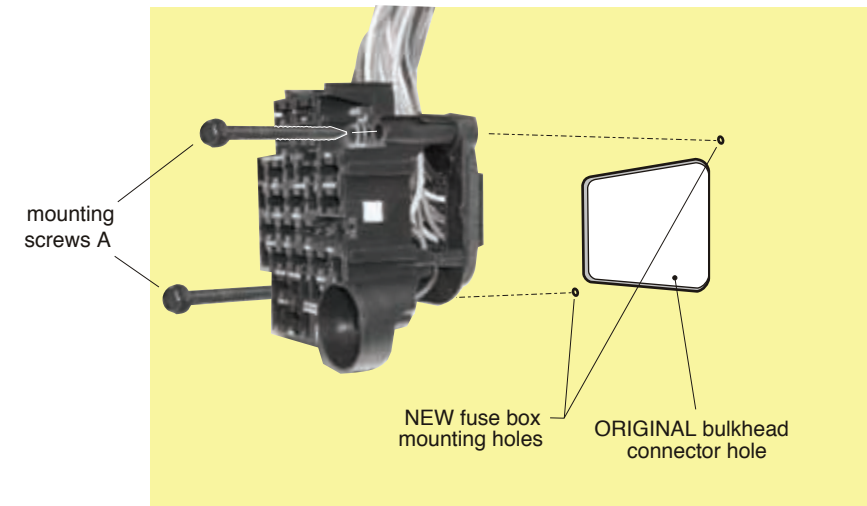

1. Locate the stock OEM bulkhead hole in the driver side of the firewall. **NOTE: You will need to modify the firewall of your car by making 2 new mounting holes only. See firewall template 92969921 to help with this operation.**
2. Mount the fuse box with the flasher can in the bottom right corner, as shown above.
3. Using the two mounting screws A, attach the fuse panel to the firewall.



www.americanautowire.com 856-933-0801



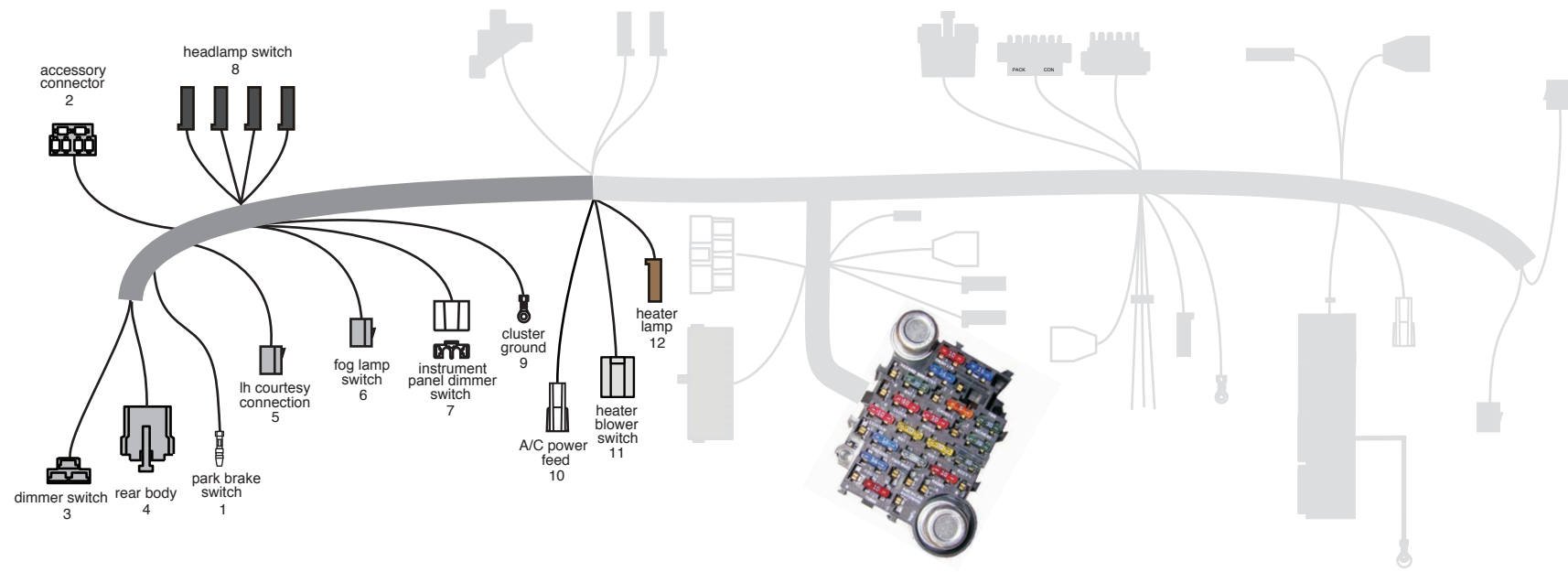

Figure A

- | | | | |
|----|----------------------|-------------|---|
| 1 | EMERGENCY BRAKE | | Connect to the emergency brake switch. This is the ground circuit for the brake warning switch lamp. |
| 2 | ACCESSORIES | Tan | Ground for parking brake warning lamp |
| | | | Use the provided connector that is plugged into the dash harness along with the loose terminals in the loose piece parts kit to connect power leads for the following: |
| | | | Fuse Rating |
| | | Tan | FUEL 15 amp Fused 12 volt IGNITION feed for fuel pump and electric speedo (may also be used to feed power to another ignition circuit) |
| | | Red | BAT1 20 amp Fused 12 volt BATTERY feed for power door locks (may also be used to feed power to another accessory circuit) |
| | | Pink | IGN1 20 amp Fused 12 volt IGNITION feed for cruise control (may also be used to feed power to another ignition circuit) |
| | | Pink | PWRWDO 30 amp Fused 12 volt IGNITION feed for power windows (may also be used to feed power to another ignition circuit) |
| | | Tan | ACCY1 30 amp Fused 12 volt ACCESSORY feed (may also be used to feed power to an accessory circuit) |
| 3 | DIMMER SWITCH | | This connector will mate to the new floor mounted dimmer switch. |
| | | Yellow | 12 volt feed into dimmer switch from H/L switch |
| | | Light Green | 12 volt feed out to high beam H/L |
| | | Tan | 12 volt feed out to low beam H/L |
| 4 | REAR BODY | | This connector will mate with the connector from the Rear Body harness 510294, bag M. |
| | | Tan | Fuel tank sender lead |
| | | Brown | Tail lamp and tag lamp feed |
| | | Yellow | LH turn / brake feed |
| | | Dark Green | RH turn / brake feed |
| | | Orange | Dome / courtesy lamp feed |
| | | White | Dome / courtesy lamp ground |
| | | Light Green | Back up lamp feed |
| | | Light Blue | Third brake light |
| 5 | LH COURTESY LAMP | | Plug this connector into the mating LH courtesy lamp assembly from 510296, bag N. |
| | | Orange | 12 volt battery fused feed |
| | | White | Courtesy lamp switched ground |
| 6 | FOG / DRIVING LAMP | | Plug this connector onto your fog / driving lamp switch if your car is equipped with this option. |
| | | Orange | 12 volt battery fused feed |
| | | Black | 12 volt switched feed to bulkhead connector |
| 7 | PANEL DIMMER SW. | | This connection will plug onto your instrument panel lamp dimmer switch. |
| | | Brown | Fused 12 volt feed from the headlight switch connection #8 to the panel dimmer switch for instrument panel lamps |
| | | Dark Green | Dash lamp output to fuse panel |
| | | White | Dome / Courtesy ground |
| 8 | HEADLIGHT SWITCH | | NOTE: The original connector for this branch is not available. Individual connections for this switch have been provided and will install and work well. See detail photo Figure A at the top of this instruction page for the proper orientation of the individual connectors. |
| | | Red | Battery unfused 12 volt input lead to switch for headlamps |
| | | Orange | Secondary battery fused 12 volt input lead to switch for park / tail lamp output and dash lamp input |
| | | Brown | Park/tail lamp output and 12 volt output to panel dimmer for dash lamps |
| | | Yellow | 12 volt output lead to dimmer switch for headlamps |
| 9 | CLUSTER GROUND | | Connect to the dash frame, steering column saddle, or any other good known chassis ground. |
| | | Black | Instrument cluster ground wire |
| 10 | AFTERMARKET AC POWER | | This is the keyed 12 volt feed for your aftermarket installed A/C system. |
| | | Brown | 12 volt accessory fused feed for aftermarket A/C power. |
| 11 | HEATER SWITCH | | Plug this connector onto your stock heater control switch. This harness does not support the use of a factory installed A/C system. |
| | | Brown | 12 volt accessory fused feed for heater power. |
| | | Lt Green | To heater resistor |
| | | Dk Green | To heater resistor |
| 12 | HEATER CONTROL LAMP | | Plug your stock heater control lamp pigtail (not supplied with this kit) into this connector. |
| | | Gray | Heater control dash lamp feed |



www.americanautowire.com 856-933-0801



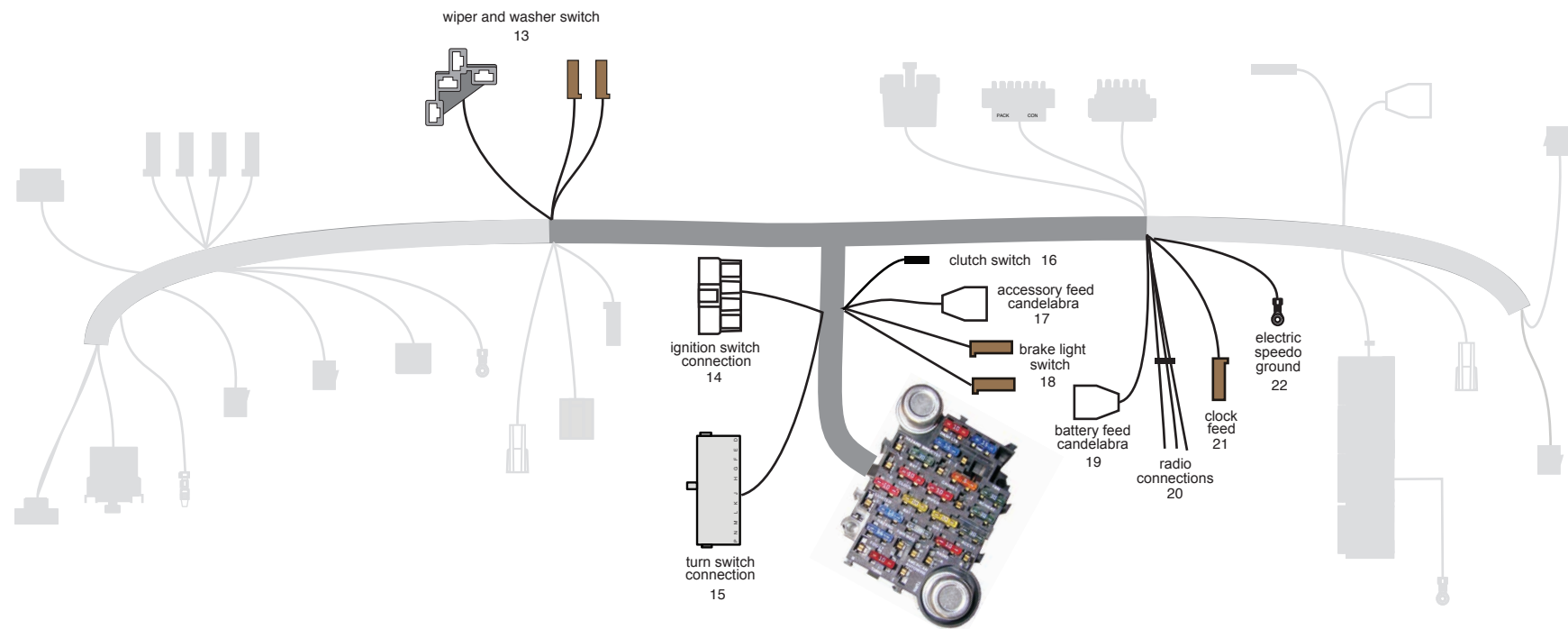

1970-71
2-speed
wiper switch

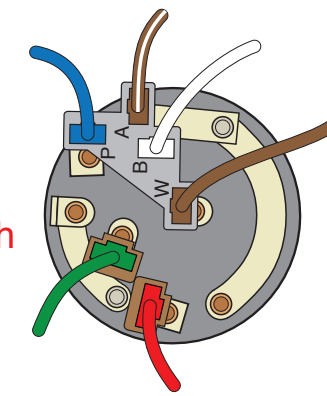

1970-71
variable-speed
wiper switch

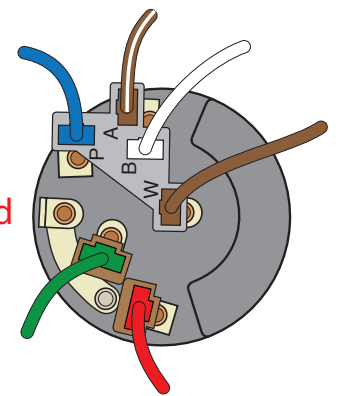

1972-74
2-speed
wiper switch

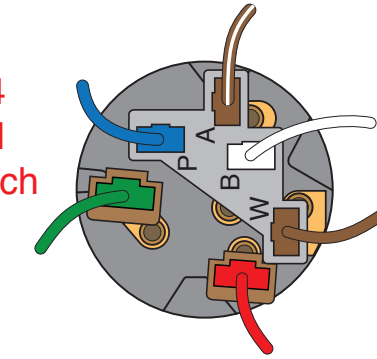

1972-74
3-speed
wiper switch

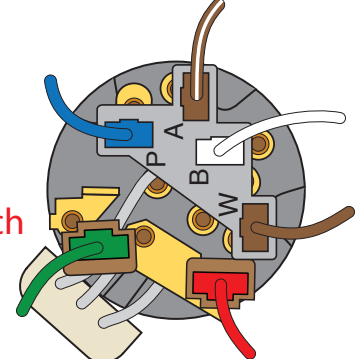

13 WIPER SWITCH

The three connectors on this dash harness will mate directly to your original wiper/washer switch (see four wiper switch connection images on this page).

- Brown/White Wiper switch
- Dk Blue Wiper switch
- Brown Wiper switch
- White 12 volt ignition fused power feed for wiper switch
- Dk Green Wiper switch
- Red Wiper switch

14 IGNITION SWITCH

NOTE: The original connector for this branch is not available. Mating terminals A and connector B to complete this connection can be found in the loose piece parts kit for this dash harness, 510291, bag G. Cut the connector off of your original ignition switch lead, crimp on terminals A and E, and plug the wires into connector B as shown in **Figure D, page 4**.

- Red 12 volt battery feed
- Pink 12 volt ignition feed
- Brown (Thick) 12 volt accessory feed
- Yellow 12 volt ignition/starter relay lead to bulkhead assembly for starter relay
- Brown (Thin) 12 volt ignition bypass lead to bulkhead assembly
- Gray Shifter quadrant lamp for steering column

15 TURN SIGNAL SWITCH

The connector on this dash harness will mate directly to the 3 7/8" turn signal switch used by GM and many other aftermarket steering column manufacturers. If you are using an aftermarket column that utilizes the 4 1/4" column connection, remove the terminals from that connector or cut the connector off and crimp terminals C onto the wires from your switch, then install the terminals into connector D maintaining color continuity with the new switch. If you are using a stock 1970-74 Mopar column and turn signal switch, an adapter and terminals have been provided to you with this kit. They can be found in the loose piece kit of this dash harness, 510291, bag G. Please refer to the table on **page 4**, Figure E for the proper wire mating configurations. Cut the connector off of your original turn signal switch lead, install terminals C on each wire and plug those wires into connector D as shown in **Figure E on page 4**. Plug this new connection onto connector 15 from above to complete your turn signal switch circuitry.

- White 12 volt feed from brake switch
- Dark Green RH rear stop and turn
- Yellow LH rear stop and turn
- Purple 12 volt ignition feed from turn signal flasher
- Brown 12 volt battery feed from hazard flasher
- Dark Blue RH front turn
- Light Blue LH front turn
- Black Horn relay ground to horn switch

16 CLUTCH SWITCH

If your car has a manual transmission, this is the clutch operated ground leg for the starter relay. Plug the bullet terminal from your clutch switch into this connection to complete this circuit.

- Black Ground from clutch switch to bulkhead connector for starter relay (manual trans cars only)

17 ACCESSORY CANDELABRA

This is a stock style fused accessory power plug. It can be used for various stock accessory powered items. Use the bullet terminals provided in the loose piece kit of this dash harness, 510291, bag G to make a connection into this power plug assembly by crimping the terminal onto any accessory powered wire, then plugging the completed wire into this rubber molded 3 way connector. Plug this connector onto your factory stop lamp switch.

- Orange 12 volt fused battery feed to stop lamp switch
- White 12 volt out to turn signal switch
- Light Blue 12 volt out to third brake lamp

19 BATTERY CANDELABRA

This is a stock style fused battery power plug. It can be used for various stock 12 volt battery powered items. Use the bullet terminals provided in the loose piece kit of this dash harness, 510291, bag G to make a connection into this power plug assembly by crimping the terminal onto any battery powered wire, then plugging the completed wire into this rubber molded 3 way connector.

- Orange 12 volt fused battery power feed to radio ("ON" and "OFF")
- Tan 12 volt fused battery feed for clock and memory
- Yellow Radio lamp wire for stock 1970-1974 radio applications
- Gray 12 volt fused battery feed for an indash clock

21 CLOCK FEED

12 volt fused battery feed for an indash clock

22 ELECTRIC SPEEDO GROUND

Connect to the dash frame, steering column pedal saddle, or any other good known chassis ground. (DO NOT attach this together with item #9 from sheet 2. They may be grounded to the same surface or area, just not under the same screw or bolt).

- Black Electric speedo ground



www.americanautowire.com 856-933-0801

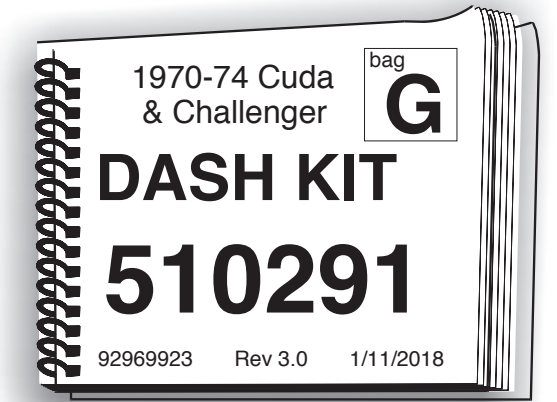

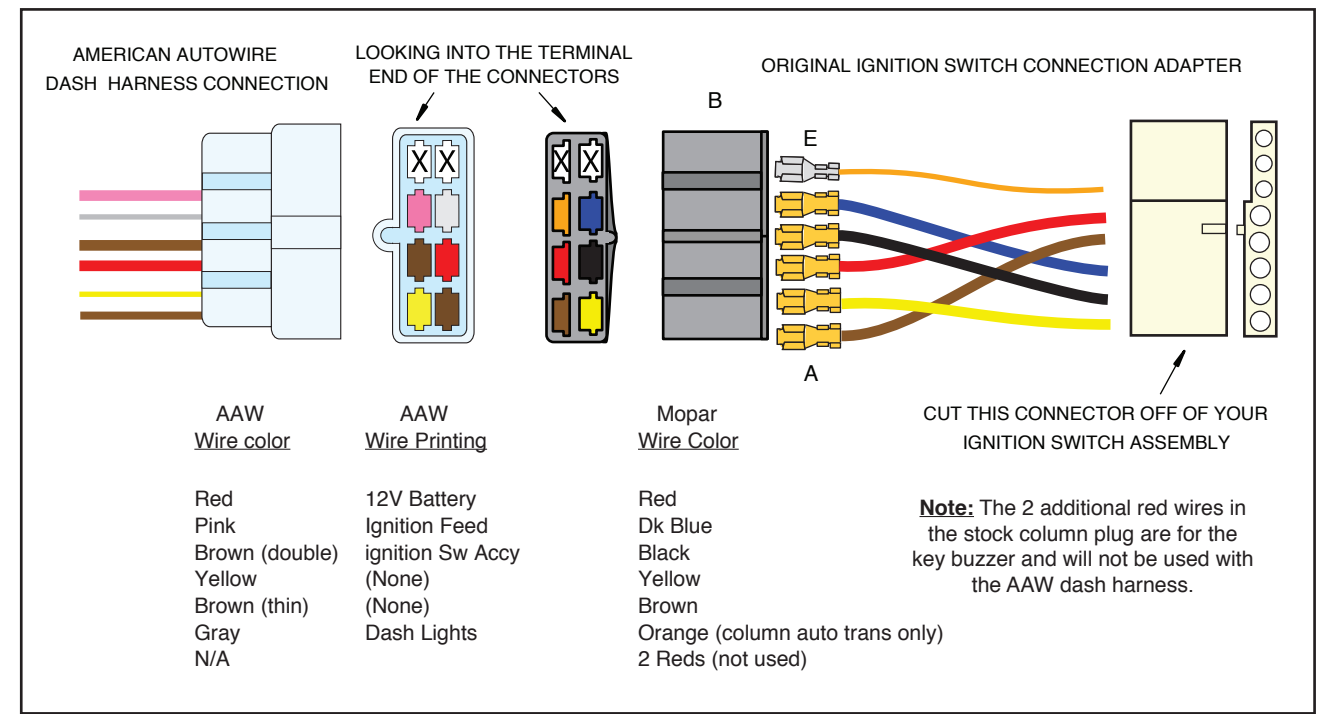
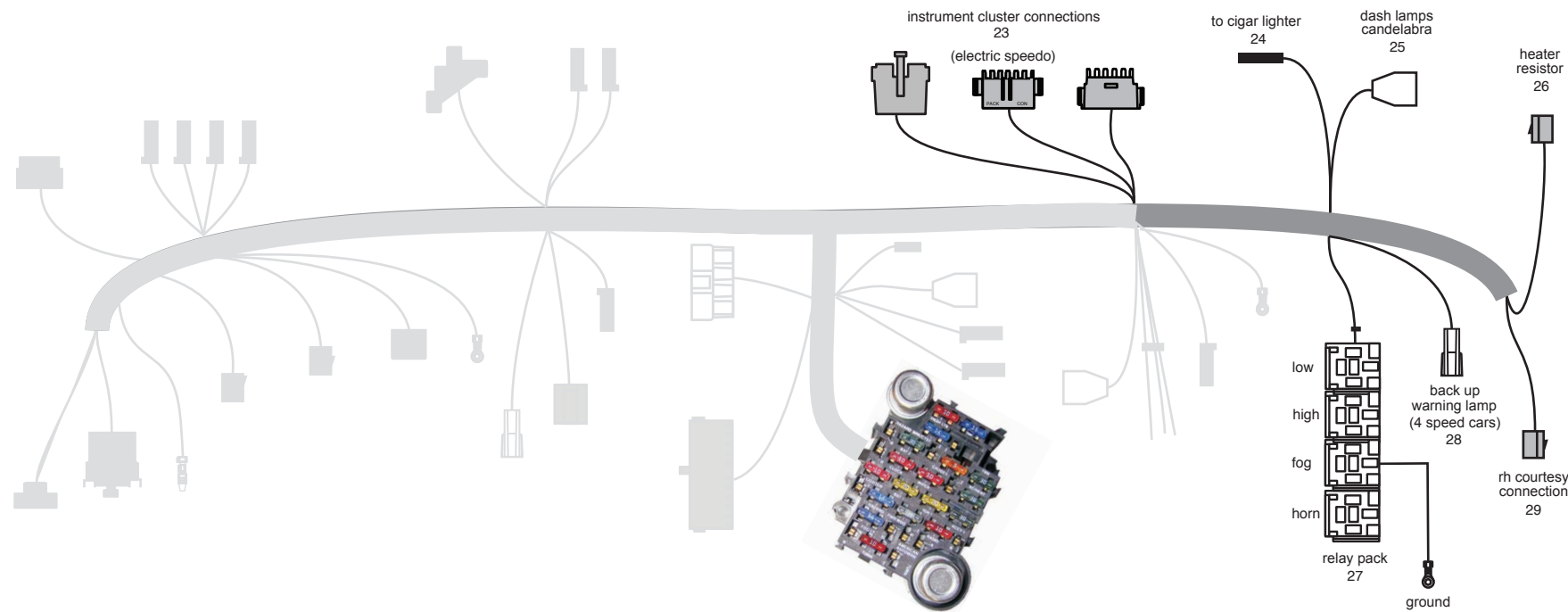

Figure D

- 23 INSTRUMENT CLUSTER DISCONNECT These connectors will plug into the the Intrument Cluster Harness, 510295, bag H. Circuit identifications for this branch are described in those instructions.
- 24 CIGAR LIGHTER Orange 12 volt fused battery feed to lighter
- 25 DASH LAMPS CANDELABRA Gray This is a stock style fused dash lamps power plug. It will be used to plug in any dash illumination lamps. Use the bullet terminals provided in the loose piece kit of this dash harness, 510291, bag G to make a connection into this power plug assembly by crimping the terminal onto any dash lamp wire, then plugging the completed wire into this rubber molded 3 way connector. (Used on stock non A/C equipped cars only) Plug this connector onto the stock heater resistor located on the stock heater box inside the car under the dash.
- 26 HEATER RESISTOR Lt Green From heater switch
Dk Green From heater switch
- 27 4 WAY RELAY PACK **NOTE:** The 4 gang relay panel is directly wired and requires no additional wiring. The only connection required is to attach the relay ground wire to a good chassis ground. Two relays control the headlight low beam and high beam circuits allowing for the use of high powered halogen lamps without creating an extra load on the factory headlamp and dimmer switches. A third relay controls the fog or driving lamp circuit and automatically shuts the fog or driving lamps off whenever the high beam lamps are applied in accordance with 50 state Federal law. The last relay is for your horn circuit.
- 28 BACK UP WARNING LAMP This feed is used on manual transmission cars only. It is the feed to the dash mounted "back up" warning lamp mounted over in the glovebox area of the dash assembly.
- 29 RH COURTESY LAMP Light Green 12 volt feed out to dash mounted back up warning lamp
Orange 12 volt battery fused feed
White Courtesy lamp switched ground

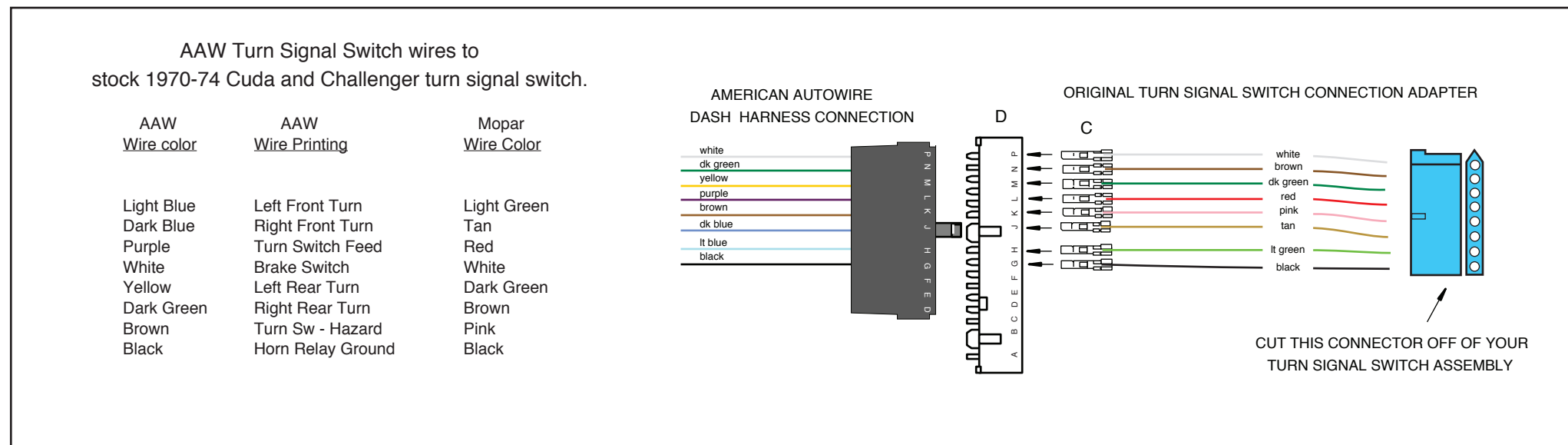

Figure E



www.americanautowire.com 856-933-0801

