

fuse box as viewed from the wire entry side

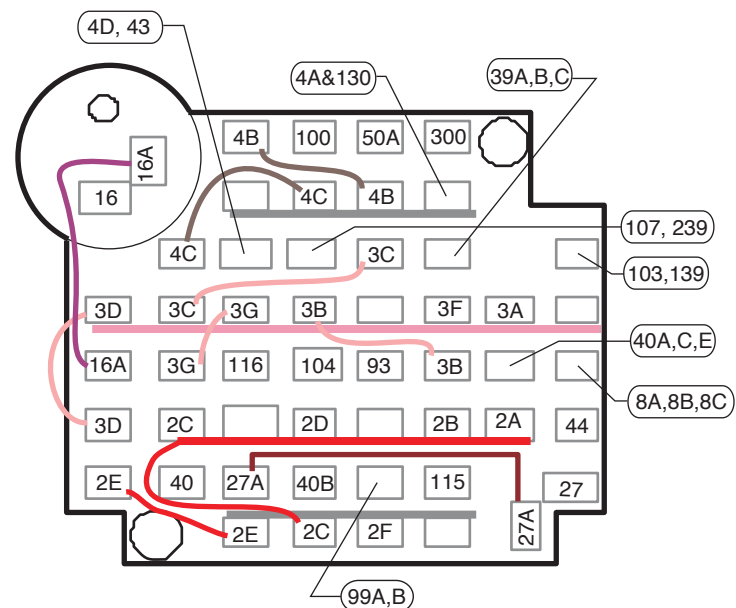

Mating connector is plugged into Power Accessory connector

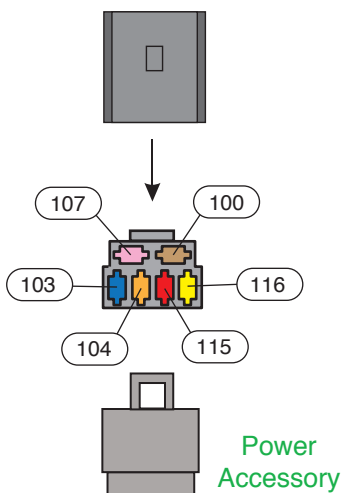

Rear Body

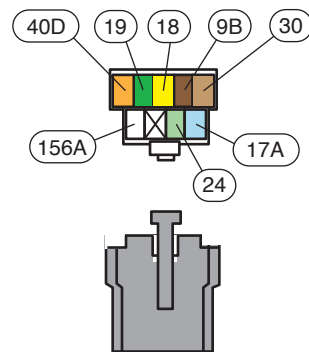

LH Courtesy Light

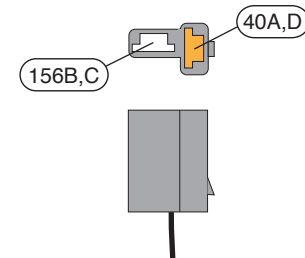

Electric Speedo ground

151

bulkhead connector as viewed from the wire entry side

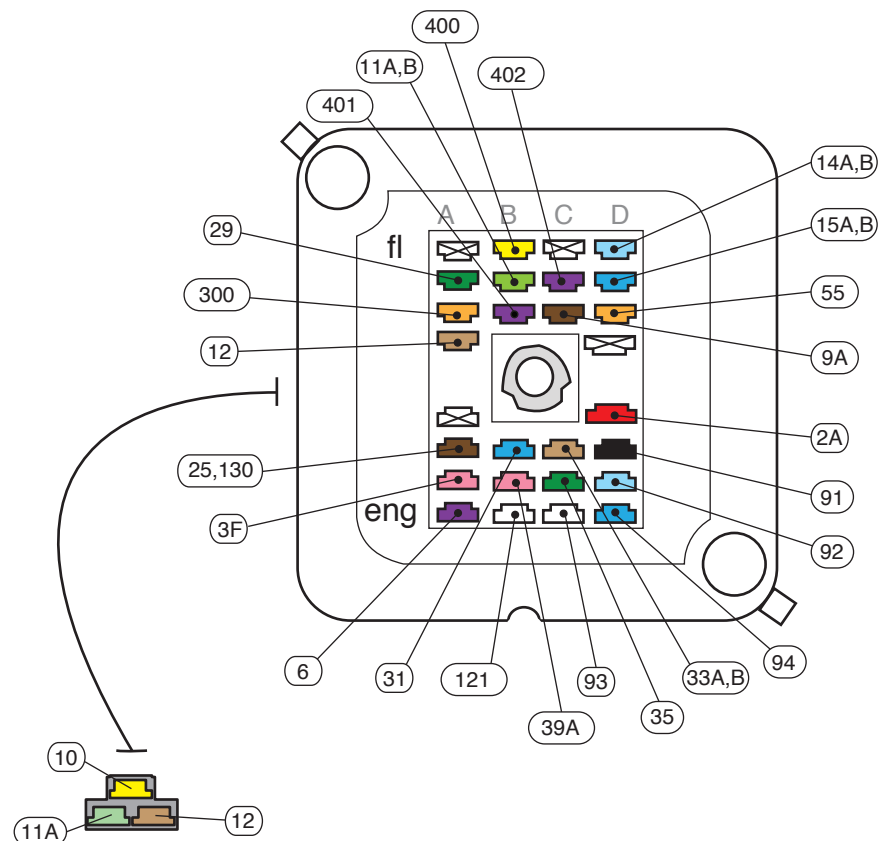

Circuit Branch #1

Circuit Branch #2

Circuit Branch #3

under hood light

4D

Horn Relay

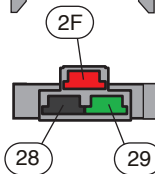

Wiper Switch

91 92 94

Headlight Switch

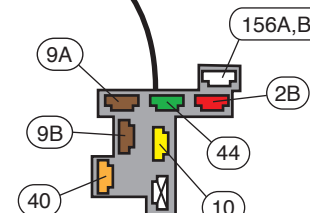

Brake Warning Switch

33A

You will use this main instruction sheet, 92971584, to complete the installation process of bag G. See page 4 of this instruction set to begin.

DASH/MAIN HARNESS

1968-72 Olds Cutlass Classic Update Series

510646

8/22/2016 Rev 1.0 JM

bag G

92971584

NOTE: wires 400 & 401, must be twisted together.

turn signal switch

Cluster Connections

(electric speed)

Ground

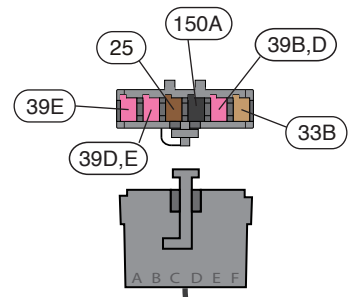

Connector "A"

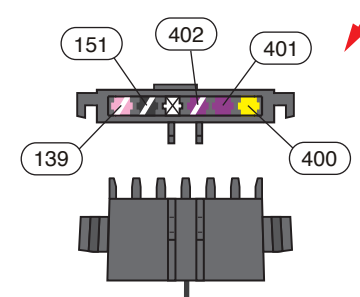

Connector "C"

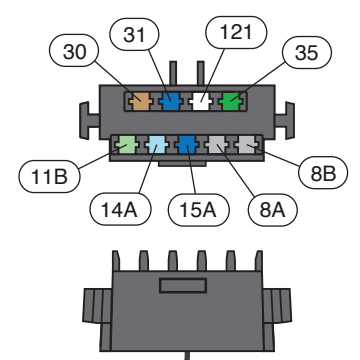

Connector "B"

150A

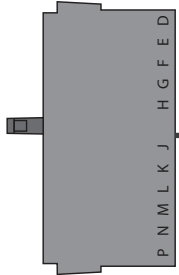
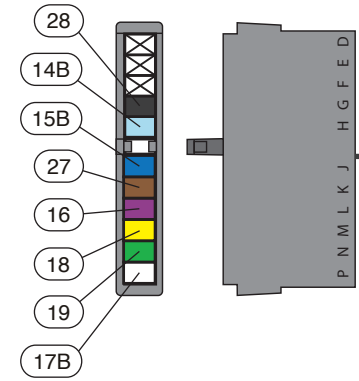

Circuit Branch #4

Circuit Branch #5

8D, E heater switch light

50A heat and A/C switch

8E clock light

99A clock

40G glove compartment light

40B cigar lighter

43 radio connections
99B

40E,F RH courtesy light
156D

8C, D console feed
40F
156C, D

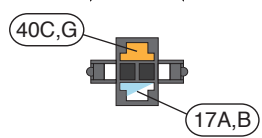

brake light switch



neutral safety switch

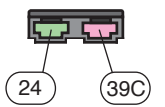

back-up warning light

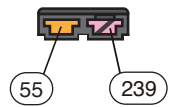

auto trans downshift switch

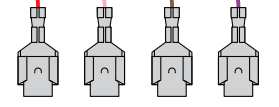

ignition switch

Parts Legend:

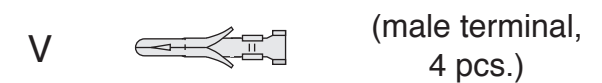
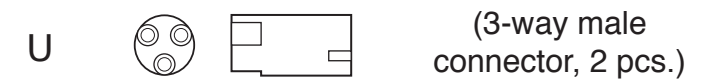
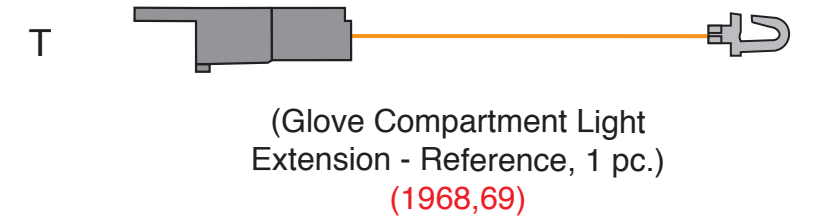
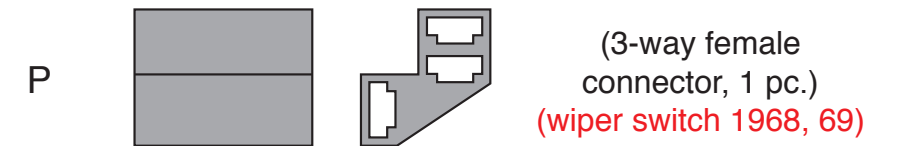
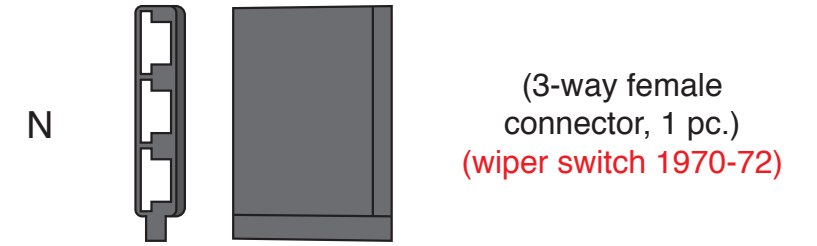
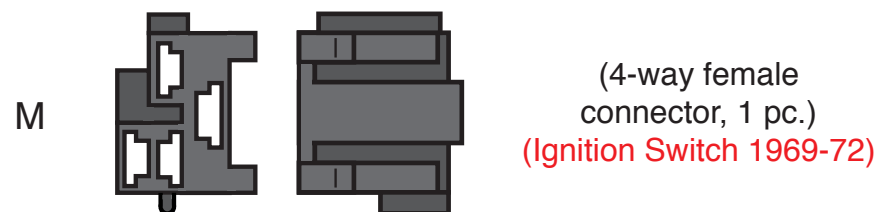
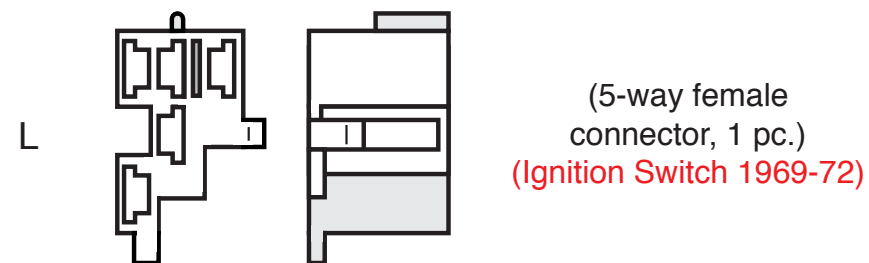
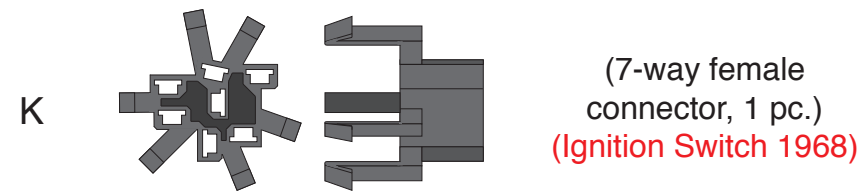
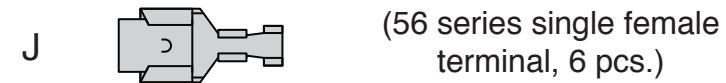
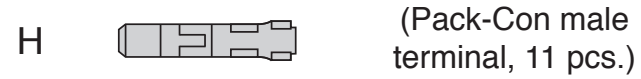
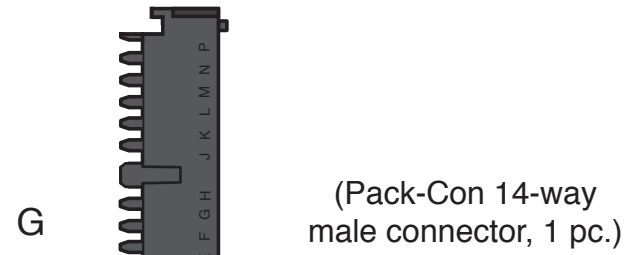
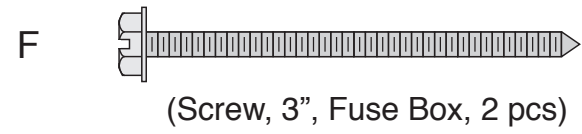
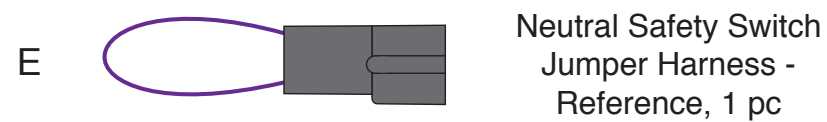
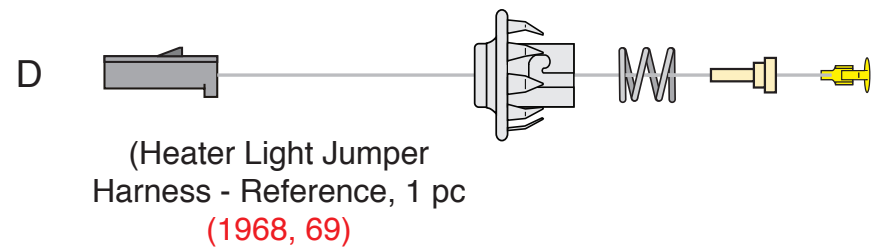
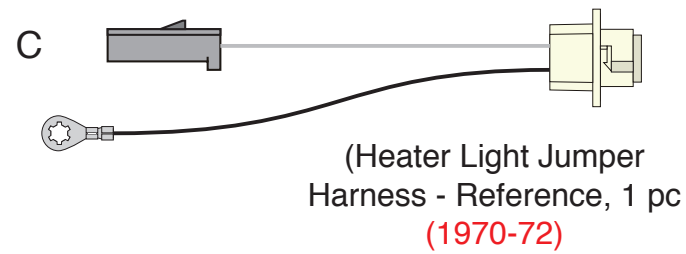
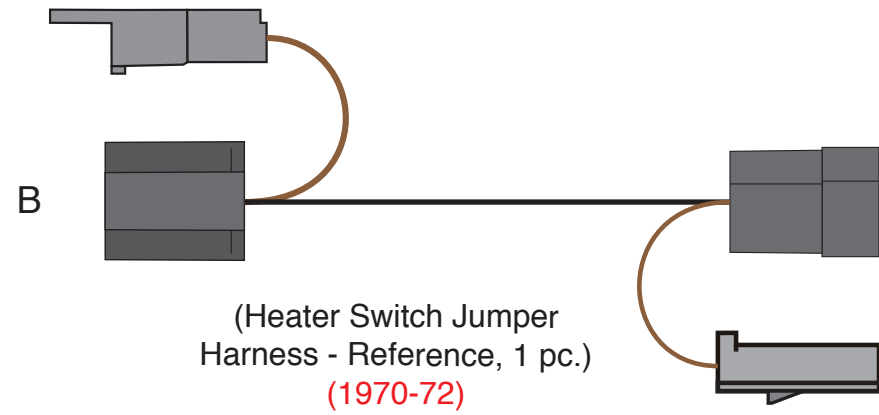
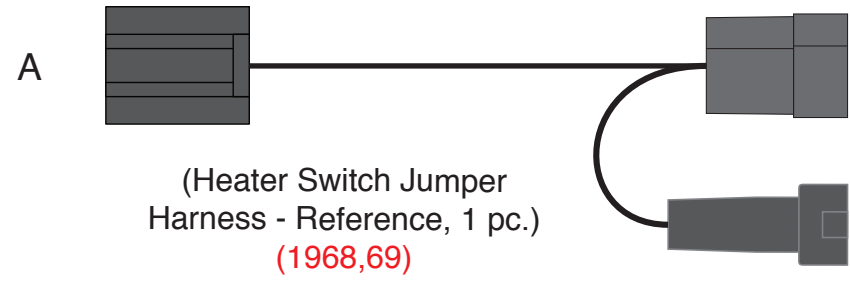

Note: Prior to installing the Dash Harness, obtain the Fuse, Flasher, and Relay Kit #500707 (located in Bag G) and plug all of the Fuses in the Fuse Block (See page 8 for the location of the fuses). Install the Horn Relay (see Circuit Branch #2) to the Dash Harness.

See the Parts Legend on page 3 for an illustration of the Jumpers and the wiring components.

Dash Harness Routing

The Dash Harness routing will be the same as the original factory Instrument Panel Wiring Harness routing. Be sure to duplicate this routing. Now proceed to the individual Circuit Branch Instructions below.

Circuit Branch #1

Bulkhead/Fuse Block Assembly Attachment

Locate the original factory Bulkhead Connector hole in the Firewall. The new Bulkhead/Fuse Block Assembly will mount in this same Firewall hole. Use 2 Screws (item "F" from Loose Parts Kit 92971585) to attach the Bulkhead/Fuse Block Assembly to the Firewall.

Headlight Dimmer Switch Connector This wiring branch will route to the Dimmer Switch 500042 (located in Bag G). Attach the 3-way Dimmer Switch connector to the Dimmer Switch and attach to the Floor Pan in the original location.

Wire #	Wire Color	Printing	Description
10	Yellow	DIMMER SW FEED	Feed from the Headlight Switch.
11A	Light Green	HEADLIGHT-HI BEAM	Feed to the High Beam Headlights.
12	Tan	HEADLIGHT-LOW BEAM	Feed to the Low Beam Headlights.

Park Brake Switch Connector Plug this male bullet Park Brake Switch connector onto your Park Brake Switch.

Wire #	Wire Color	Printing	Description
33A	Tan	BRAKE LIGHT/SWITCH	Wire from the Brake Warning Light to the Park Brake Switch.

Under Hood Light Connector Plug this 1-way black connector onto your Under Hood Light.

Wire #	Wire Color	Printing	Description
4D	Brown	no printing	Feed to the original factory Under Hood Light.

Power Accessory Connector Use the provided 6-way empty connector, which is attached to the 6-way Power Accessory connector on the Dash Harness, and terminals "J" and "R" (see Page 3 – the Parts Legend) included in Parts Kit 92971585 in Bag G, to add power wires (not provided) for the following optional systems:

Dash Harness Power Accessory Connector

Wire #	Wire Color	Printing	Name on Fuse Block	Fuse Rating	Description
100	Tan	no printing	ACCY1	30A	Fused 12 volt ACCESSORY feed (may also be used to feed power to an accessory circuit).
103	Dark Blue	no printing	FUEL	15A	Fused 12 volt IGNITION feed for fuel pump (may also be used to feed power to another ignition circuit).
104	Orange	no printing	BAT1	20A	Fused 12 volt BATTERY feed for power seats (may also be used to feed power to another battery circuit).
107	Pink	no printing	IGN1	20A	Fused 12 volt IGNITION feed for cruise control (may also be used to feed power to another ignition circuit).
115	Red	no printing	BAT2	30A	Fused 12 volt BATTERY feed for power door locks (may also be used to feed power to another battery circuit).
116	Yellow	no printing	PWRWDO	30A	Fused 12 volt IGNITION feed for power windows (may also be used to feed power to another ignition circuit).

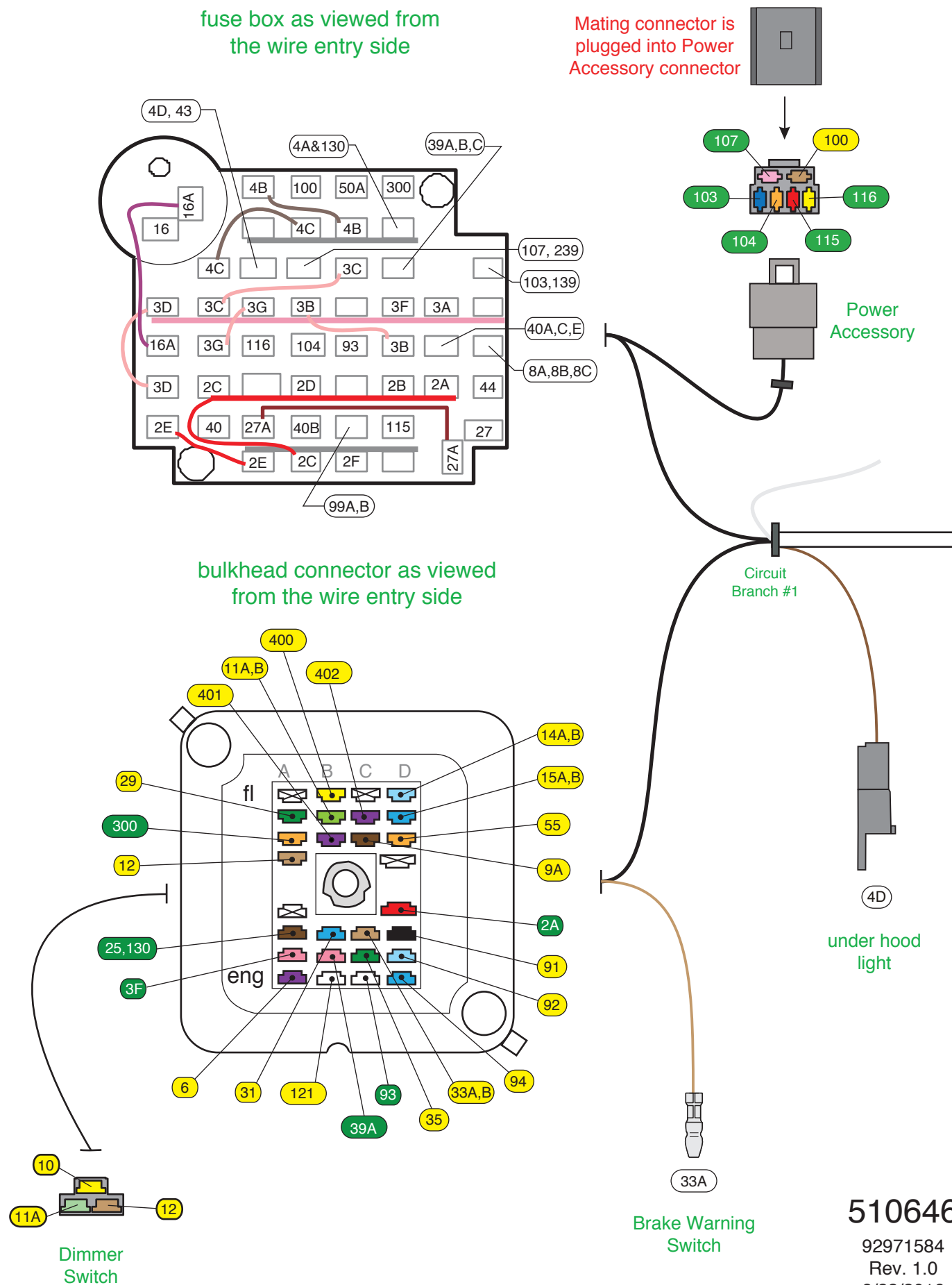

Circuit Branch #1 (continued)

Rear Body Connector This 9-way connector will plug into the 9-way connector of the **Rear Body Harness Kit 510650 in Bag M**.

Wire #	Wire Color	Printing	Description
9B	Brown	REAR RUNNING LIGHTS	Feed for the Tail Lights, the License Light, the Rear Running Lights, and the Rear Side Marker Lights.
17A	Light Blue	THIRD BRAKE LIGHT	Feed for an aftermarket Third Brake Light.
18	Yellow	LEFT REAR TURN	Feed to the Left Rear Stop and Turn Lights.
19	Dark Green	RIGHT REAR TURN	Feed to the Right Rear Stop and Turn Lights.
24	Light Green	BACK UP LT SW --> LIGHTS	Feed from the Back-up Light Switch to the Back-up Lights.
30	Tan	GAS GAUGE	Fuel Tank Sender.
40D	Orange	12V BATTERY-FUSED	12V Battery feed to the Trunk Light.
156A	White	CTSY GROUND	Switched Ground for the Dome/Courtesy Lights.

Use connector "U" and terminal "V", to connect #500708 Courtesy Light harness, to your stock door jamb switches.

Circuit Branch #2

Horn Relay Connector If you haven't already; plug the **Horn Relay** (included in kit #510646 in Bag G) into this connector.

Wire #	Wire Color	Printing	Description
2F	Red	12V BATTERY	12V Battery feed to the Horn Relay.
28	Black	HORN RELAY GROUND	Relay ground circuit to the Steering Column Horn Switch.
29	Dark Green	HORN	Feed to the Horns.

Circuit Branch #3

Left Hand Courtesy Light See Courtesy Light Connection Kit #500708 in Bag N, for Courtesy Light harness installation instructions. If you are using your stock door jamb switches, replace the single bullet type terminal, of the #500708 harness, with terminal "V" and connector "U". **NOTE: This Courtesy Light utilizes a #631 Bulb (which is not included in this kit).**

Wire #	Wire Color	Printing	Description
40A, D	Orange	12V BATTERY – FUSED	12V Battery feed to the LH Courtesy Light.
156B, C	White	CTSY GROUND	Switched ground for the LH Courtesy Light.

Aftermarket Electric Speedo Ground **Note: Do not attach this ring terminal with any other ground ring terminal; it must be grounded all by itself to a good vehicle ground.**

Wire #	Wire Color	Printing	Description
151	Black/White	SPEEDO GROUND	Ground for an Aftermarket Electric Speedometer.

Wiper Switch Connections Use either connector "N" or "P", depending on the application. See page 8 for installation instructions.

Wire #	Wire Color	Printing	Description
91	Black	WIPER-LO SPEED GROUND	Low speed signal to the Wiper Motor.
92	Light Blue	WIPER-HI SPEED GROUND	High speed signal to the Wiper Motor.
94	Dark Blue	WIPER - WASHER GROUND	Signal from Washer Switch to Washer Motor.

Headlight Switch Connector Plug this 8-way connector onto the Headlight Switch.

Wire #	Wire Color	Printing	Description
2B	Red	12V BATTERY	12V Battery feed to the Headlight Switch for the Headlights.
9A	Brown	PARK LIGHTS	Feed to the Front Park Lights.
9B	Brown	REAR RUNNING LIGHTS	Feed to the Rear Running Lights.
10	Yellow	DIMMER SW FEED	Feed to the Headlight Dimmer Switch.
40	Orange	12V BATTERY-FUSED	12V Fused Battery feed to the Headlight Switch for the Park Lights, the Courtesy Lights, the Dome Light, and the Trunk Light.
44	Dark Green	no printing	Feed for Park/Rear Running lights.
156A, B	White	CTSY GROUND	Switched ground for the LH Courtesy Light.

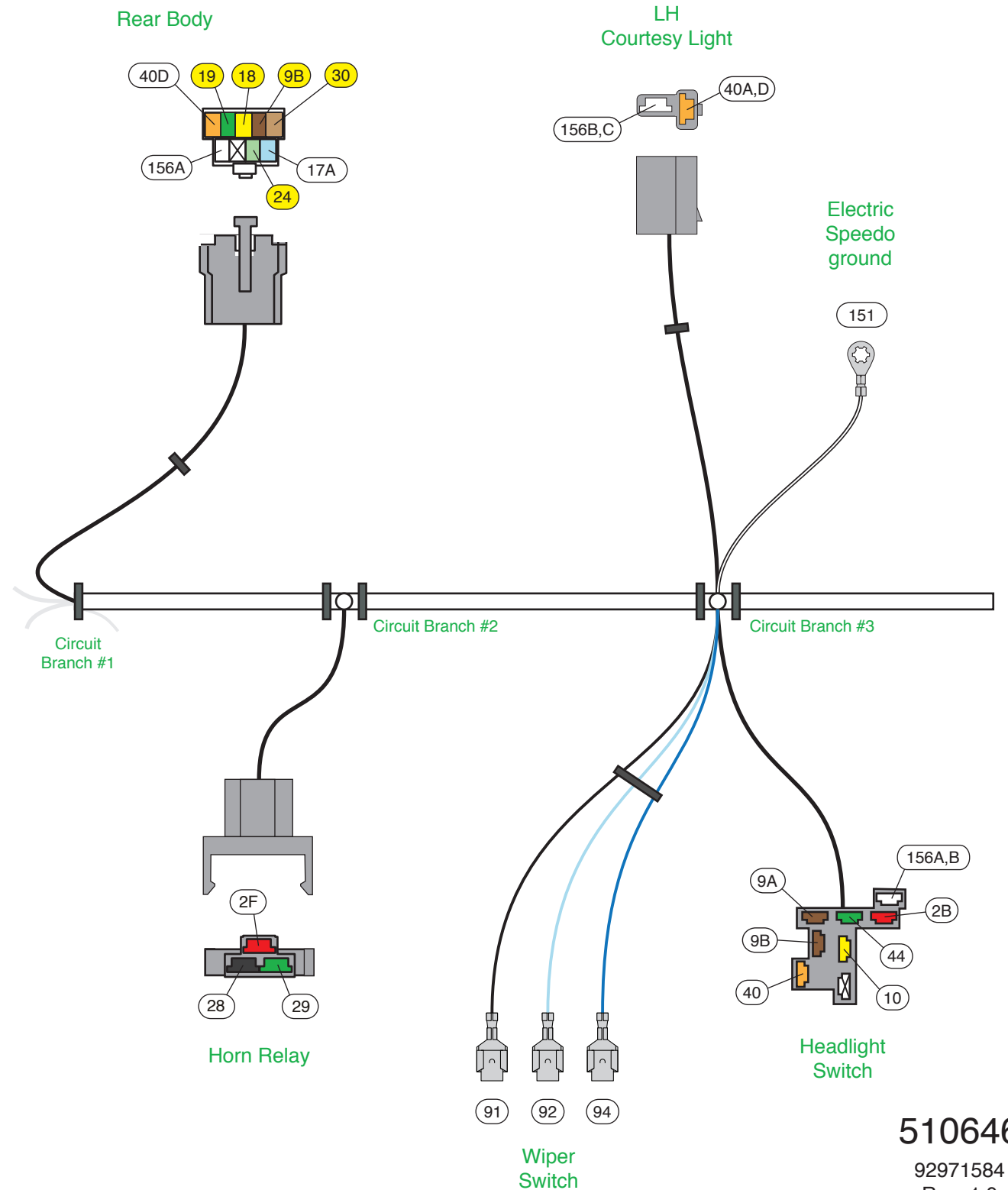

510646

92971584
Rev. 1.0
8/22/2016

Circuit Branch #4

Turn Signal Switch Preparation NOTE: For all of the vehicles, the Turn Signal Switch is mounted to the Steering Column. You will continue to use this original Turn Signal Switch, but will have to remove the original connector from the pigtail and replace this connector with the black 14-way connector "G" and terminals "H" (located in Parts Kit 92971585 in Bag G). See Diagram 'A' and "Table A" on page 8 for details.

Turn Signal Switch Connector Once you have modified the original Turn Signal Switch Pigtail by adding the black 14-way male connector "G", obtain the 11-way Turn Signal Switch connector, which is part of the Dash Harness, and plug it into the 14-way connector "G" of the Turn Signal Switch.

Wire #	Wire Color	Printing	Description
14B	Light Blue	LEFT FRONT TURN	Left Front Turn Signal feed.
15B	Dark Blue	RIGHT FRONT TURN	Right Front Turn Signal feed.
16	Purple	TURN SWITCH FEED	Turn Signal Switch feed from the Turn Signal Flasher.
17B	White	BRAKE SW	Brake Switch feed to the Turn Signal Switch.
18	Yellow	LEFT REAR TURN	Feed to the Left Rear Turn Signal Light.
19	Dark Green	RIGHT REAR TURN	Feed to the Right Rear Turn Signal Light.
27	Brown	TURN SW – HAZARD	Feed from the Hazard Flasher.
28	Black	HORN RELAY	Ground from the Horn Relay to the Horn Switch.

Instrument Cluster Connections These connectors will plug to the connectors of the **Gauge Cluster Kit 510636 in Bag H.**

Cluster Connector "A"

Wire #	Wire Color	Printing	Description
25	Brown	ALTERNATOR IGN	Alternator warning light feed.
33B	Tan	BRAKE	Brake warning light feed.
39B, D	Pink	12V IGNITION	12V Fused Ignition feed.
39D, E	Pink	12V IGNITION	12V Fused Ignition feed.
39E	Pink	12V IGNITION	12V Fused Ignition feed.
150A	Black	GROUND	Cluster ground.

Cluster Connector "B"

Wire #	Wire Color	Printing	Description
8A	Gray	DASH LIGHTS	Illumination Light feed for the Cluster Illumination Lights.
8B	Gray	DASH LIGHTS	Illumination Light feed for the Cluster Illumination Lights.
11B	Light Green	HI BEAM INDICATOR LIGHT	Feed to the High Beam Indicator Light.
14A	Light Blue	LEFT DASH IND	Feed for the Left Turn Signal Indicator Light.
15A	Dark Blue	RIGHT DASH IND	Feed for the Right Turn Signal Indicator Light.
30	Tan	GAS GAUGE	Fuel Gauge Signal from the Fuel Tank Sending Unit.
31	Dark Blue	OIL PRESSURE SENDER	Oil Pressure Sender Signal from the Engine.
35	Dark Green	WATER TEMP SENDER	Water Temperature Sender Signal from the Engine.
121	White	COIL --> TACH	Tachometer feed to the Ignition Coil.

Cluster Connector "C" This connector contains the wires for an **Aftermarket Electric Speedometer**. NOTE: Wires "400" and "401" must remain twisted together.

Wire #	Wire Color	Printing	Description
139	Pink/White	SPEEDO POWER	Fused 12V Ignition feed for the Electric Speedometer.
151	Black/White	SPEEDO GROUND	Electric Speedometer Ground.
400	Yellow	VSS GROUND	Vehicle Speed Sensor Ground.
401	Purple	VSS SIGNAL	Vehicle Speed Sensor Signal.
402	Purple/White	VSS POWER	Vehicle Speed Sensor Power.

Brake Light Switch Connector Connect this 2-way black connector to the Brake Switch; polarity doesn't matter.

Wire #	Wire Color	Printing	Description
17A, B	Light Blue/White	BRAKE SW	Brake Switch feed to the Turn Signal Switch.
40C, G	Orange	12V BATTERY-FUSED	12V Battery Fused feed from the Fuse Block.

Neutral Safety Switch Connector Plug into original Neutral Safety Switch. If you are **not** using a NSS, plug the "E" Neutral Safety Switch Jumper Harness into the Neutral Safety Switch connector on the Dash Harness, in order for the car to start.

Wire#	Wire Color	Printing	Description
5A	Purple	NEUTRAL SAFETY SWITCH	Goes from NSS to starter solenoid.
6	Purple	STARTER SOLENOID-S	Feed from Ignition Switch to NSS.

Back-up Warning Light Connector (4-spd Manual Transmission Vehicles only) This connector provides a feed to the Back-up Gear Warning Light that is mounted on the lower Dash for Manual Transmission vehicles. Plug the pigtail of your original Back-up Light into this connector.

Wire #	Wire Color	Printing	Description
24	Light Green	BACK UP LT SW --> LIGHTS	Feed from the Back-up Light Switch.
39C	Pink	12V IGNITION	Fused 12V Ignition feed to the Back-up Light Switch.

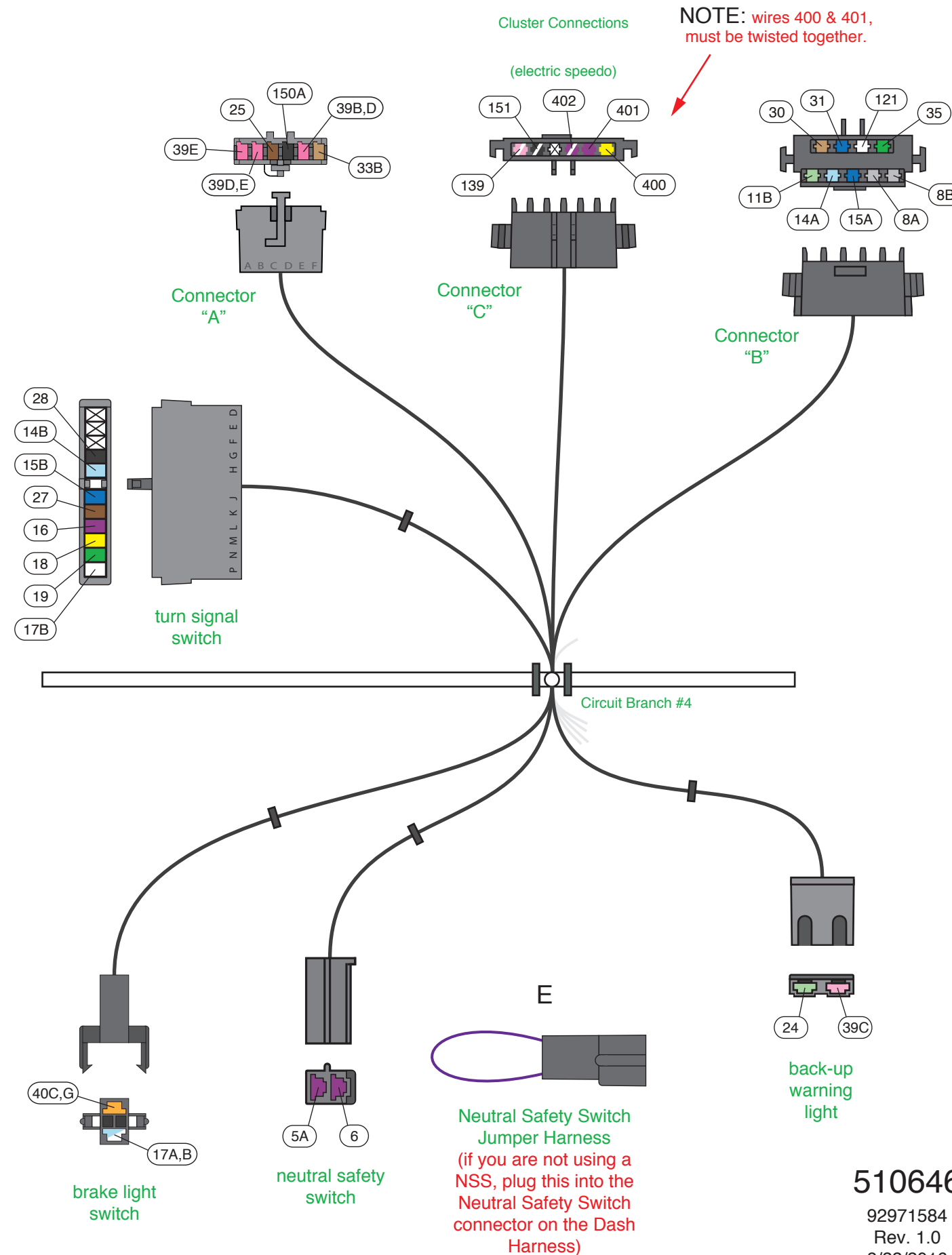

Circuit Branch #4 continued

Auto Trans Downshift Switch Connector Connect this 2-way black connector to the transmission downshift switch.

Wire #	Wire Color	Printing	Description
55	Orange	no printing	Feed from downshifter switch to transmission.
239	Pink/Black	no printing	12V feed to downshifter switch.

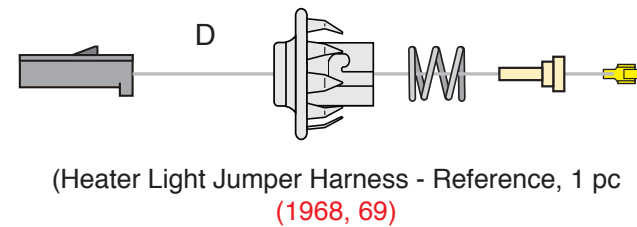
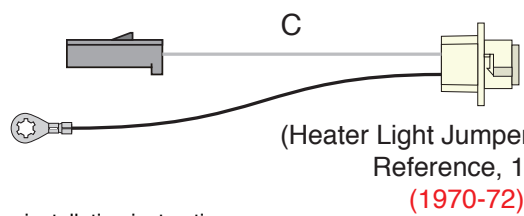

Ignition Switch Connection Use either connector "K" or connectors "L" and "M", depending on the application. See page 8 for installation instructions.

Wire #	Wire Color	Printing	Description
2D	Red	12V BATTERY	12V Battery feed.
3A	Pink	IGNITION FEED	12V Ignition feed from the Ignition Switch.
4A	Brown	IGNITION SW ACCY	12V Accessory feed from the Ignition Switch.
5A	Purple	NEUTRAL SAFETY SWITCH	Feed from Ignition Switch to Neutral Safety Switch.

Ground **Note: Be sure to attach this ground ring terminal to a good vehicle ground. If not attached to ground, your Cluster Lights may not be functional.**

Wire #	Wire Color	Printing	Description
150A	Black	GROUND	Ground wire.

Circuit Branch #5

Heater Switch Light Connector This 1-way black connector will plug into either the "C" or "D" Heater Light Jumper, depending on the application

Wire #	Wire Color	Printing	Description
8D, E	Gray	DASH LIGHTS	Illumination Light feed wire for the Heater Control Assembly Light.

Heater-A/C Switch Connector This 1-way black connector will plug into the Heater Control Assembly, using Heater Switch Jumper "A" or "B", depending on the application.

Wire #	Wire Color	Printing	Description
50A	Brown	HEATER/AC FEED	12V feed from the Fuse Block.

Clock Light Connection

Wire #	Wire Color	Printing	Description
8E	Gray	DASH LIGHTS	Illumination Light feed wire for the Clock Light.

Clock Connector

Wire #	Wire Color	Printing	Description
99A	Yellow	CLOCK BAT	12V feed for clock.

Glove Compartment Light Connector For model years 1970-72, plug the 1-way black connector into the Glove Compartment Light. For model years 1968-69, plug the 1-way black connector into the Glove Compartment Light Extension "T".

Wire #	Wire Color	Printing	Description
40G	Orange	12V BATTERY - FUSED	Illumination Light feed wire for the Glove Compartment Light.

Cigar Lighter Connector Connect the Cigar Lighter female bullet connector to the Cigar Lighter.

Wire #	Wire Color	Printing	Description
40B	Orange	no printing	Fused 12V Battery feed to the Cigar Lighter.

Radio Wires These wires are provided for your Radio.

Wire #	Wire Color	Printing	Description
43	Tan	RADIO	12V Fused Accessory Feed to the Radio for "On/Off" power.
99B	Yellow	RADIO BAT	12V Fused Battery Feed for the Radio Memory.

Right Hand Courtesy Light See Courtesy Light Connection Kit #500708 in Bag N, for Courtesy Light harness installation instructions. If you are using your stock door jamb switches, replace the single bullet type terminal, of the #500708 harness, with terminal "V" and connector "U". **NOTE: This Courtesy Light utilizes a #631 Bulb (which is not included in this kit).**

Wire #	Wire Color	Printing	Description
40E, F	Orange	12V BATTERY - FUSED	12V Battery feed to the LH Courtesy Light.
156D	White	CTSY GROUND	Switched ground for the LH Courtesy Light.

Console Connector This connector is provided to connect to 510658 Console Connection Kit.

Wire #	Wire Color	Printing	Description
8C, D	Gray	DASH LIGHTS	Dash Light feed to the Console Light.
40F	Orange	12V BATTERY-FUSED	Fused 12V Battery feed to the Console.
156C, D	White	CTSY GROUND	Switched ground for the Console Courtesy Lights.

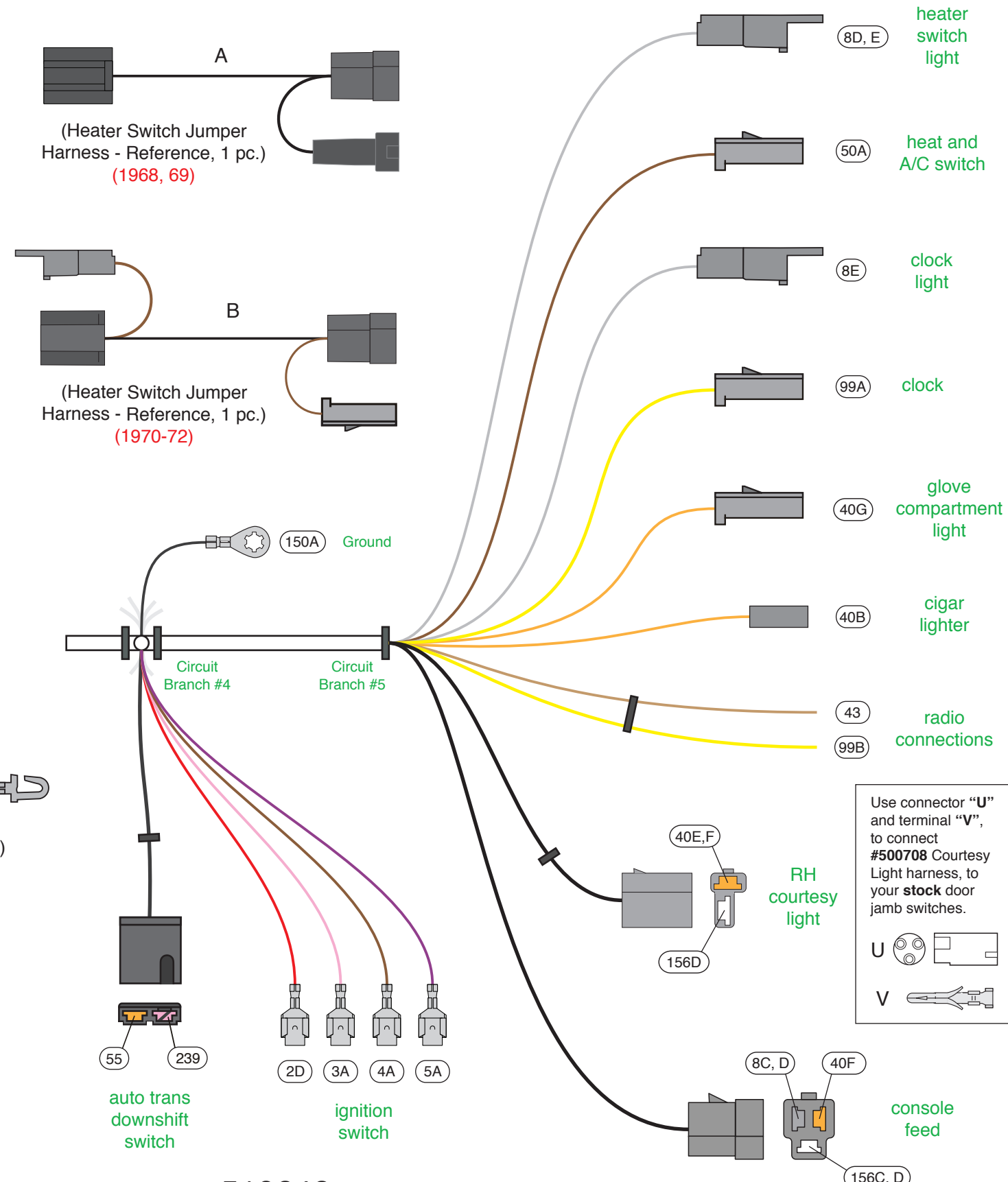
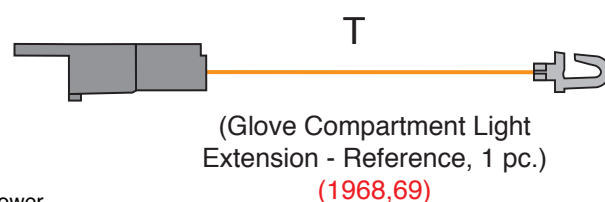

Use connector "U" and terminal "V", to connect #500708 Courtesy Light harness, to your stock door jamb switches.

AMERICAN AUTOWIRE DASH HARNESS CONNECTION

TURN SIGNAL SWITCH WIRING

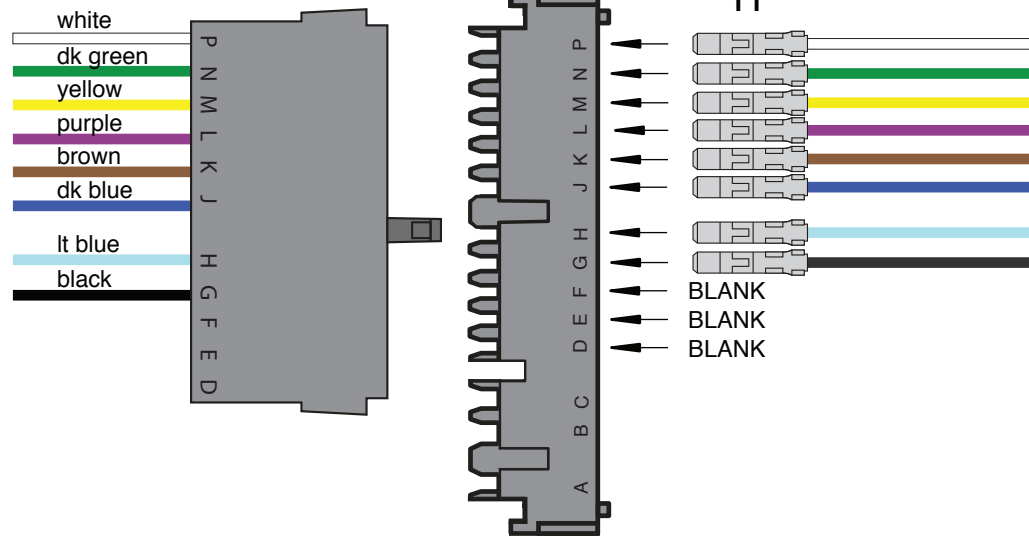

DIAGRAM 'A' - AAW Turn Signal Switch Wires

"Table A"

AAW Turn Signal Switch wires to stock 1968-72 Olds Cutlass Turn Signal Switch

AAW Wire #	AAW Wire Color	AAW Wire Printing	Connector Cavity	Function
17B	White	Brake SW	P	White
19	Dark Green	Right Rear Turn	N	Dark Green
18	Yellow	Left Rear Turn	M	Yellow
16	Purple	Turn Switch Feed	L	Purple
27	Brown	Turn SW - Hazard	K	Brown
15B	Dark Blue	Right Front Turn	J	Dark Blue
14B	Light Blue	Left Front Turn	H	Light Blue
28	Black	Horn Relay Ground	G	Black
None	None	None	F	None
None	None	None	E	None
None	None	None	D	None

NOTE: The Steering Column Horn Button switches ground for a Horn Relay, which then switches power to the Horns, similar to the AAW design.

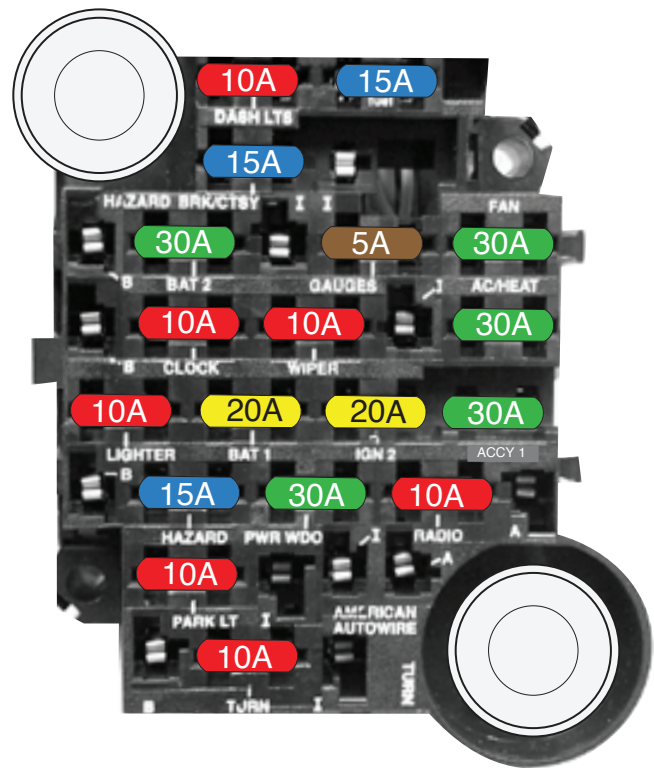

Populated Fuse Block

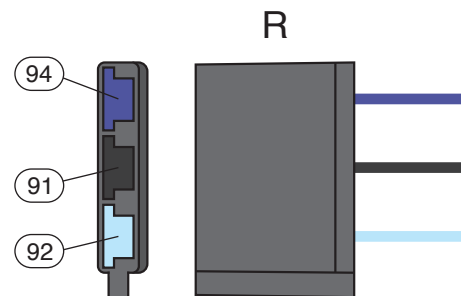

(3-way female connector, 1 pc.)
(wiper switch 1970-72)

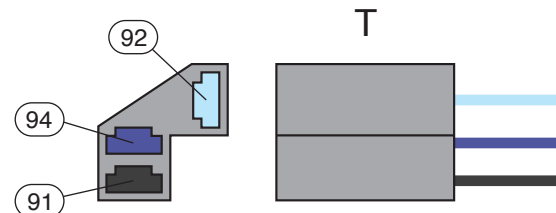

(3-way female connector, 1 pc.)
(wiper switch 1968, 69)

Wiper Switch connections

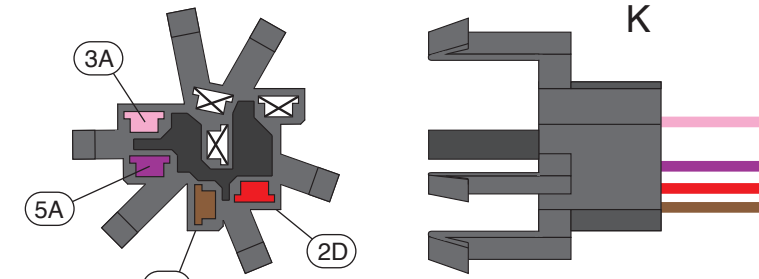

(7-way female connector, 1 pc.)
(Ignition Switch 1968)

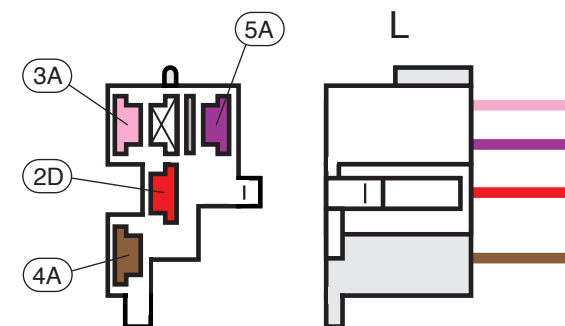

(5-way female connector, 1 pc.)
(Ignition Switch 1969-72)

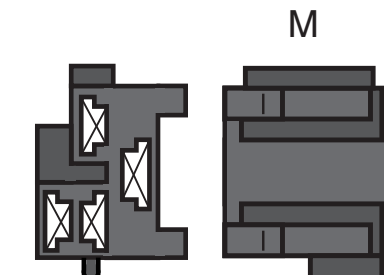

(4-way female connector, 1 pc.)
(Ignition Switch 1969-72)

Ignition Switch connections

CONNECTOR "M" HAS NO WIRES, BUT IS ATTACHED TO CONNECTOR "L" IN ORDER TO INSTALL IT ONTO THE IGNITION SWITCH.