

Classic Update Series

1971-73 Ford Mustang

START HERE !

PLEASE READ THIS BEFORE STARTING INSTALLATION !

This wiring kit is designed for ease of installation. Please read the guidelines below, BEFORE STARTING your installation to guarantee a successful job. Use an appropriate crimping tool which folds the wings of the open barrel terminals down into the wire as shown below. If you use our crimping tools and correctly crimp the included terminals, soldering is not necessary. If you are unsure about a particular crimp, soldering is recommended. Our factory crimped terminations are installed by GM approved five ton presses, and soldering these terminations is not necessary. AAW offers a great terminal crimping video entitled "Proper Crimping Video". It can be viewed by visting YouTube. Type the following address into your web browser to go directly to the video: www.youtube.com/watch?v=JAgEDoVI-co.



PLEASE READ THESE HELPFUL INSTALLATION TIPS BEFORE GOING ANY FURTHER!

Prior to installing the Dash/Main harness in your vehicle, plug all of the fuses (see a detailed picture, on [page 4](#), of the fuse installation locations), into this harness.

AS THIS HARNESS IS DESIGNED FOR USE IN A MODIFIED VEHICLE REQUIRING A HIGHER RATE OF CHARGE, IT DOES NOT SUPPORT THE USE OF A STOCK (ORIGINAL) ALTERNATOR. IT IS DESIGNED FOR USE WITH AN INTERNALLY REGULATED GM "SI" STYLE OR SINGLE WIRE STYLE ALTERNATOR. ADAPTERS (WHICH ARE NOT INCLUDED WITH THIS KIT) THAT ARE AVAILABLE FROM SEVERAL SOURCES WILL BE NECESSARY TO USE ANY ALTERNATOR OTHER THAN A GM "SI" STYLE OR SINGLE WIRE STYLE UNIT.

STEP 1: DISCONNECT YOUR BATTERY:

Disconnect the battery before installing the wiring kit to prevent any accidental shorting caused by loose bare wire ends.

STEP 2: START INSTALLING KIT (see [page 7](#)):

This kit is broken down into individual steps that are identified by a letter printed on the instruction sheets visible through each bag. These letters are the order of operation for installing your kit, start with bag letter G. The order of installation is shown below. You will use this main instruction sheet, **92971679**, to complete the installation process of bag G. See [page seven](#) of this instruction set and Fuse Block Mounting instruction sheet **92971696** to begin.

G - 510663 Dash Harness Kit

H - 510664 Gauge Cluster Kit

M - 510667 Rear Body Kit

STEP 3: RECONNECT YOUR BATTERY:

When you have completed the installation and are ready to reconnect the battery, make sure that the following electrical system grounds are in place:

- Battery is grounded to the ENGINE BLOCK.
- Battery is grounded to the frame.
- Engine block is grounded to the frame.
- Body is grounded to the frame.

STEP 4: CHECK ALL ELECTRICAL FUNCTIONS:

Any non-functioning items should be checked for proper installation. Any problems with your wiring and electrical circuit functions should be addressed to American Autowire Systems, Inc. as soon as possible to avoid any warranty problems.

If you have any questions concerning this or any of our products, please feel free to call us at 1-856-933-0801.

AMERICAN AUTOWIRE MAKES IT EASY !!

We carry many accessories for your 1971-73 Ford Mustang

p/n 510585
OEM small terminal crimping
tool (18-14 gauge)



p/n 510586
OEM large terminal crimping
tool (12-8 gauge)



p/n 510587
Includes Both
terminal crimping tools



p/n 500479
Universal Relay Kit

p/n 500093
Universal Waterproof
Relay Kit



p/n 500918
Ford Duraspark
Ignition Harness



p/n 500801
Ballast Resistor Kit

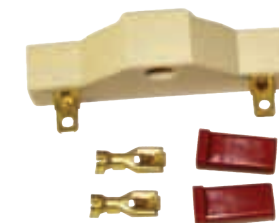

p/n 500802
GM "SI" series to Ford "3G"
int. regulated alternator



www.americanautowire.com 856-933-0801

Classic Update Series

1971-73 Ford Mustang

510662

© COPYRIGHT 2004 American Autowire / Factory-Fit
Used with express permission of
American Autowire / Factory-Fit

92971679 Rev. 1.0 7/21/2017

MAIN HARNESS

1971-73 Ford Mustang
Classic Update Series

510662

Rev 1.0 7/21/2017 JM

92971679

92971679



www.americanautowire.com 856-933-0801

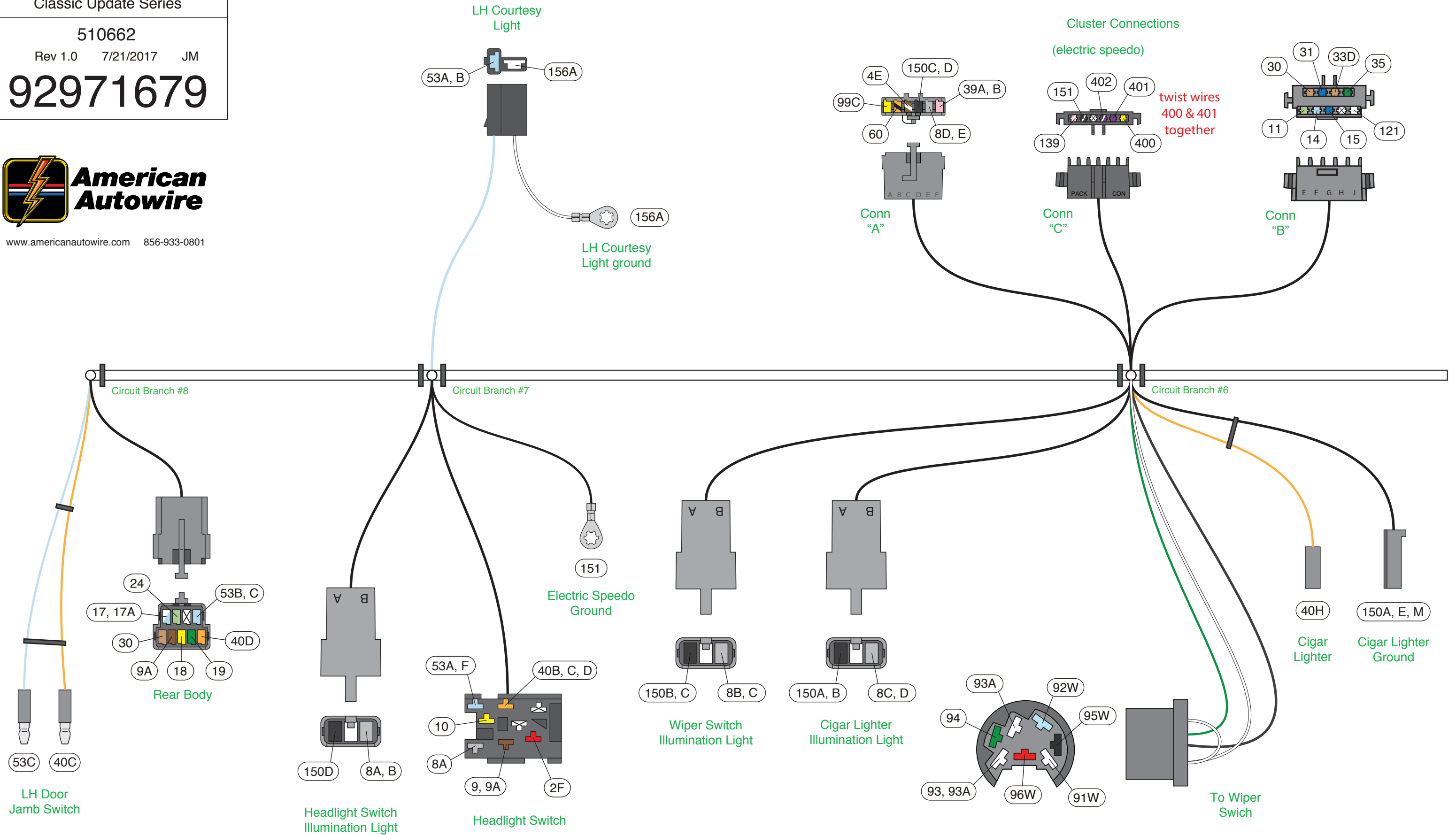

92971679

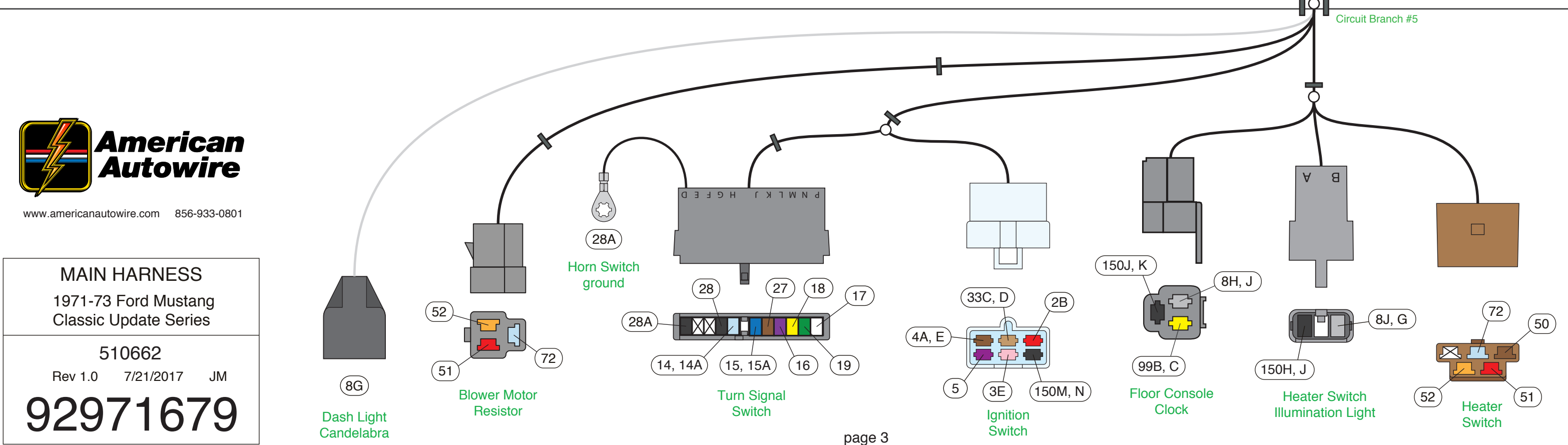
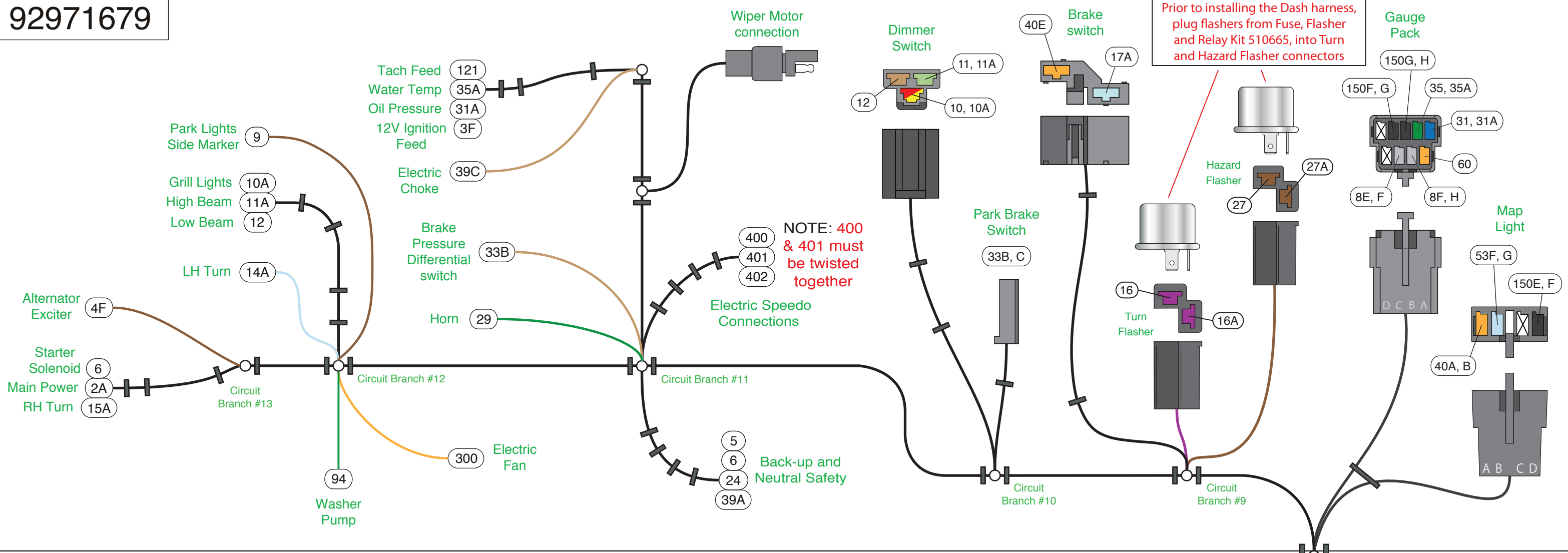

www.americanautowire.com 856-933-0801

MAIN HARNESS

1971-73 Ford Mustang
Classic Update Series

510662

Rev 1.0 7/21/2017 JM

92971679

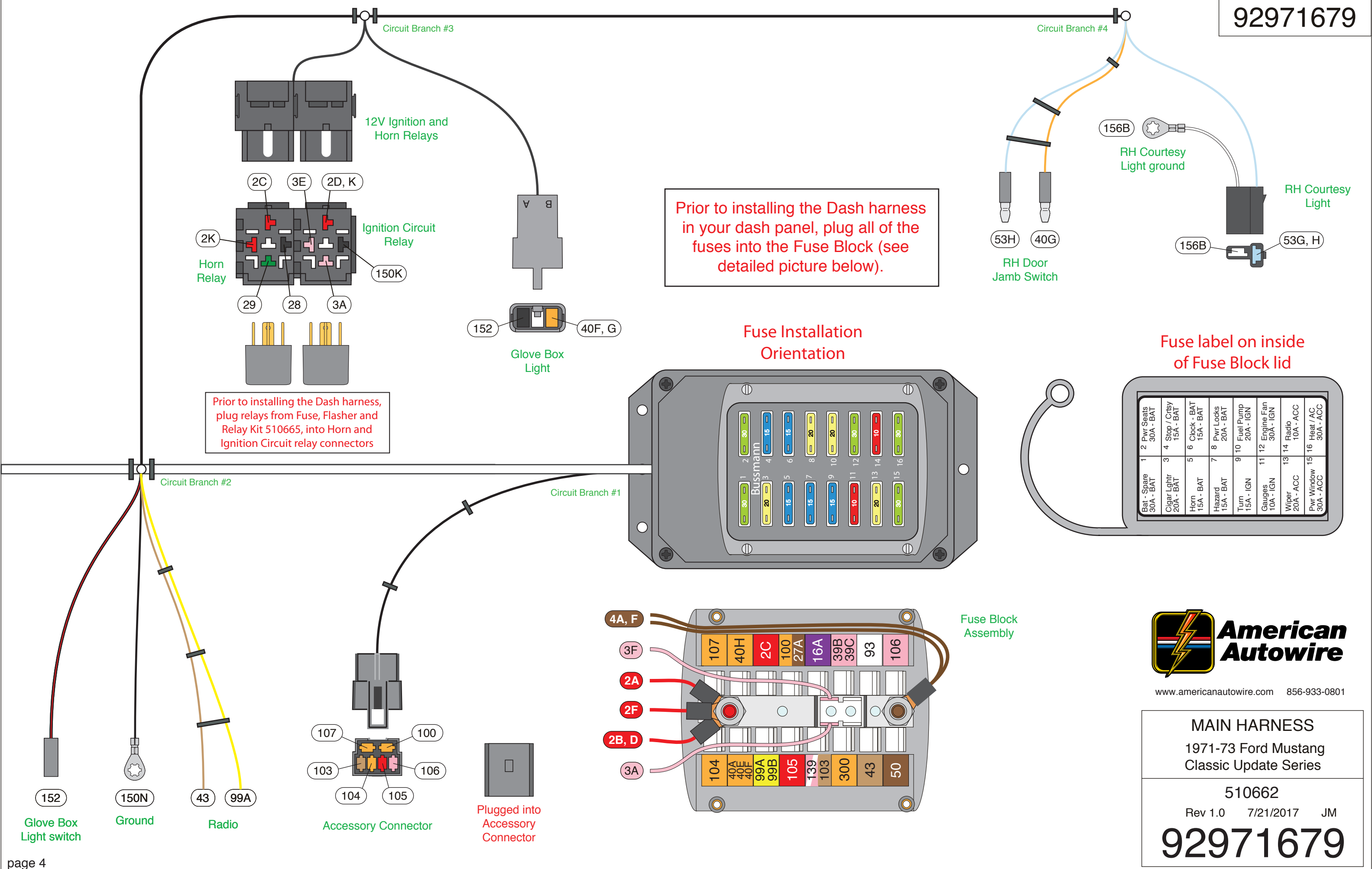

Prior to installing the Dash harness in your dash panel, plug all of the fuses into the Fuse Block (see detailed picture below).

Prior to installing the Dash harness, plug relays from Fuse, Flasher and Relay Kit 510665, into Horn and Ignition Circuit relay connectors

Fuse Installation Orientation

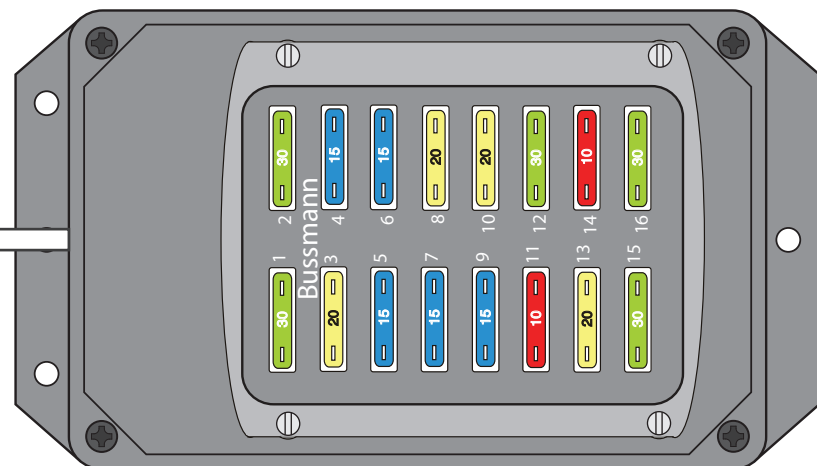

Fuse label on inside of Fuse Block lid

1	Bat - Spare 30A - BAT	2	Pwr Seats 30A - BAT	3	Cigar Lighter 20A - BAT	4	Stop / Crispy 15A - BAT	5	Horn 15A - BAT	6	Clock - BAT 15A - BAT	7	Hazard 15A - BAT	8	Pwr Locks 20A - BAT	9	Turn 15A - IGN	10	Fuel Pump 20A - IGN	11	Gauges 10A - IGN	12	Engine Fan 30A - IGN	13	Wiper 20A - ACC	14	Radio 10A - ACC	15	Pwr Window 30A - ACC	16	Heat / AC 30A - ACC
---	--------------------------	---	------------------------	---	----------------------------	---	----------------------------	---	-------------------	---	--------------------------	---	---------------------	---	------------------------	---	-------------------	----	------------------------	----	---------------------	----	-------------------------	----	--------------------	----	--------------------	----	-------------------------	----	------------------------



www.americanautowire.com 856-933-0801

MAIN HARNESS
1971-73 Ford Mustang
Classic Update Series

510662
Rev 1.0 7/21/2017 JM

92971679

Legend:

B  (connector, 56 series, 1-way female, 5 pcs.)

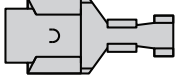
C  (terminal, 56 series, single female, 15 pcs.)

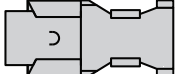
D  (terminal, 56 series, double female, 13 pcs.)

E  (sleeve, rubber, large, 3 pcs.)

F  (connector, 56 series, 1-way female, 4 pcs.)

G  (connector, 56 series, 1-way male, 1 pc.)

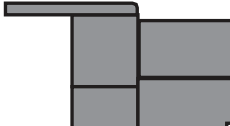
H  (connector, 56 series 3-way male, 2 pcs.)

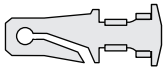
J  (terminal, 56 series, single male, 10 pcs.)

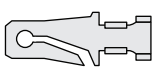
K  (terminal, 56 series, double male, 2 pcs.)

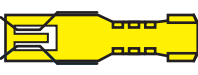
L  (terminal, wedge base, single female, 2 pcs.)

M  (terminal, wedge base, double female, 2 pcs.)

N  (connector, 56 series, 3-way female, 4 pcs.)

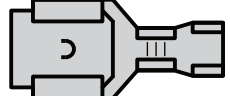
P  (terminal, 59 series, single female, 3 pcs.)

Q  (terminal, 59 series, double female, 3 pcs.)

R  (sleeve, rubber, small, 4 pcs.)

S  (ring terminal, 2 pcs.)

T  (ring terminal, 2 pcs.)

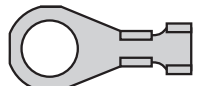
U  (ring terminal, 4 pcs.)

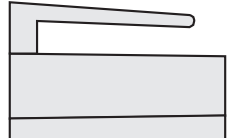
V  (connector, 56 series, 1-way female, 1 pc.)

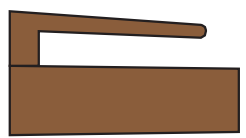
W  (connector, 56 series, 1-way female, 1 pc.)

MAIN HARNESS

1971-73 Ford Mustang
Classic Update Series

510662

Rev 1.0 7/21/2017 JM

92971679



www.americanautowire.com 856-933-0801

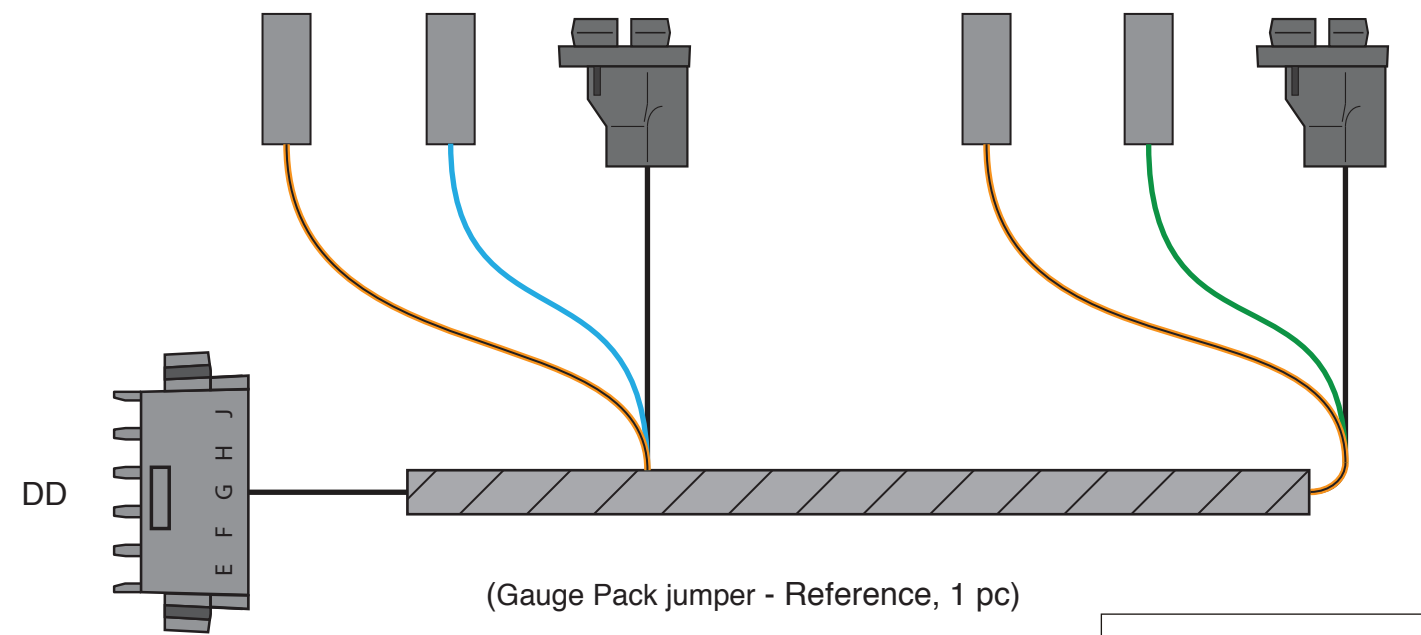
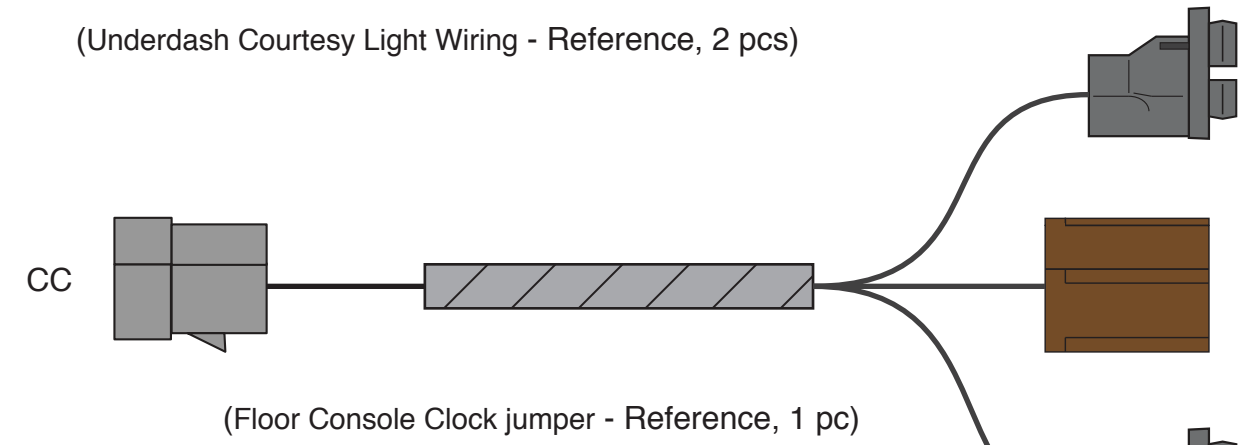
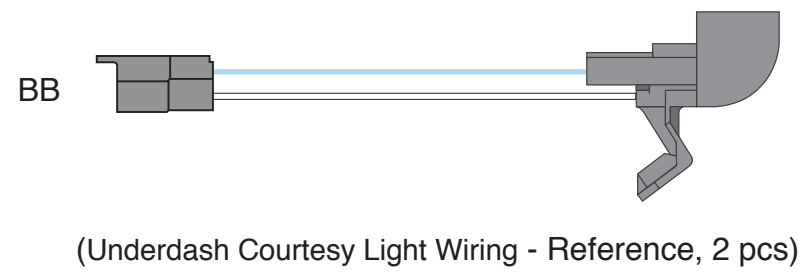

Legend (cont'd):



(Glove Box Light jumper - Reference, 1 pc)



(Brake Pressure Differential Warning Switch Extension - Reference, 1 pc)

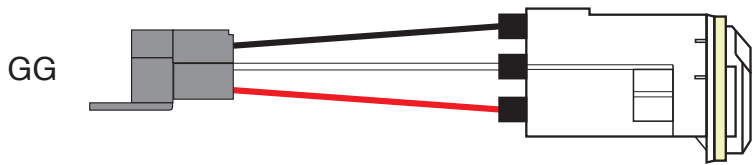

(Park, Turn and Grill Light jumpers - Reference, 2 pcs)



(Front Side Marker jumpers - Reference, 2 pcs)



(Headlight jumpers - Reference, 2 pcs)



(Main Power Feed Fusible Link - Reference, 1 pc)



(Starter Solenoid Resistor Bypass Wiring - Reference, 1 pc)



(Alternator Feed Wiring - Reference, 1 pc)



(GM "SI" Alternator Exciter Wiring - Reference, 1 pc)

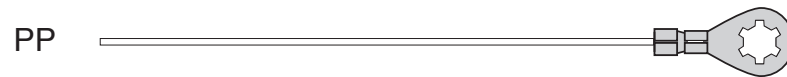

(Grill Light Ground Wires - Reference, 2 pcs)

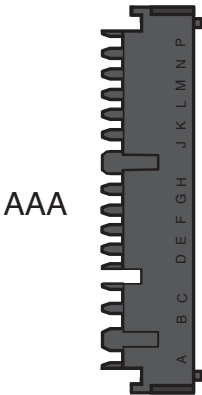

(connector, Pack-Con, 14-way male 1 pc.)



(terminal, Pack-Con, male, 16 pcs.)

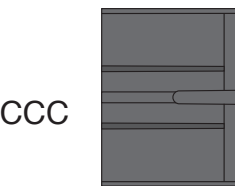

(connector, 6-way female, 1 pc.)



(terminal, 56 series, single female, 13 pcs.)



(terminal, 56 series, double female, 11 pcs.)



(bracket, 2 pcs)

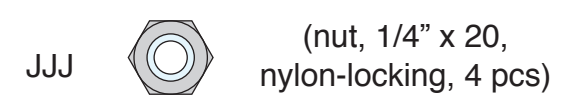

(nut, 1/4" x 20, nylon-locking, 4 pcs)



(clamp, metal, large, 3 pcs)

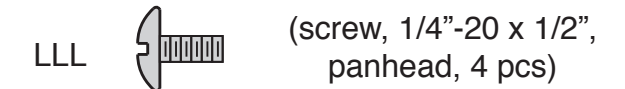

(screw, 1/4"-20 x 1/2", panhead, 4 pcs)



(clamp, metal, small, 1 pc)

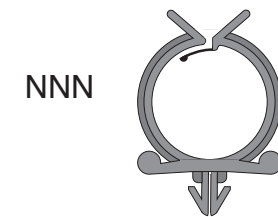

(clip, wraparound, 7 pcs)

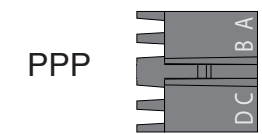

(connector, Pack-Con, 4-way male, 1 pc.)

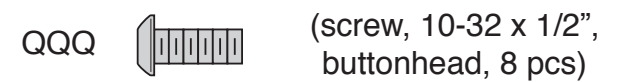

(screw, 10-32 x 1/2", buttonhead, 8 pcs)

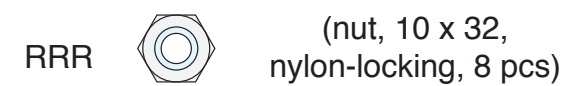

(nut, 10 x 32, nylon-locking, 8 pcs)

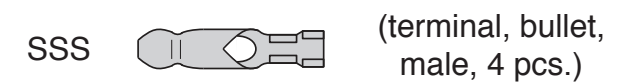

(terminal, bullet, male, 4 pcs.)



(sleeve, rubber, 4 pcs.)

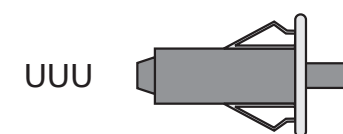

(switch, door jamb, 2 pcs.)

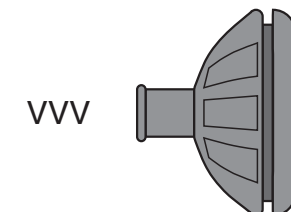

(grommet, firewall, 1 pc.)



www.americanautowire.com 856-933-0801

92971679

MAIN HARNESS
1971-73 Ford Mustang
Classic Update Series

510662
Rev 1.0 7/21/2017 JM
92971679

Reference Information:

In the Engine Compartment, all loose Terminals and Connectors, that are required to install the Dash Harness can be found in Parts Kit 92971694 and are denoted with one letter "X" on the Legend Page.

The various Dash Harness Jumper Harnesses can be found in Bag G and are denoted with two letters: "XX". See pages 5 and 6 of the Instructions for a depiction of the Jumper Harnesses.

In the Passenger Compartment, all loose Terminals, Connectors, Screws, Nuts, Clamps, Clips, and Door Jamb Switches, that are required to install the Dash Harness can be found in Kit 92971684 and are denoted with three letters "XXX".

Prior to installing the Dash Harness:

1. Remove the Dash Panel from the car and remove the original Instrument Panel Wiring Harness from the Dash Panel. The new Dash Harness will attach to the Dash Panel and then the Dash Panel will be installed in the car.
2. Disconnect the original Headlamp/Dash Harness from the Fuse Block Bracket and any other wiring. Unplug the harness from the Dimmer Switch and the Park Brake Switch, unseat the Firewall Grommet and remove the Headlamp/Dash Harness from the Passenger Compartment.
3. Obtain the **Fuse, Flasher, and Relay Kit 510665 (located in Bag G)** and plug all of the Fuses into the Fuse Block (See page 4 for the location of the Fuses). Plug the two Flashers into the Dash Harness (located in Circuit Branch #9). Don't plug the two Relays into the Relay Connectors (located in Circuit Branch #3) until after you mount the Relay Connectors to the Glove Box Relay Bracket.
4. Obtain the **Headlight Switch Kit 510385** and the **Wiper Switch 510668** and verify that the Dash Harness Connectors (located in Circuit Branches #6 and #7) will plug into the switches with ease. Some slight adjustment of the blade terminals in the switch may help with alignment.
5. Obtain 7 **Wraparound Nylon Clips "NNN"** and install them to the Dash Panel (as shown in photos #1 and #2). The clips are designed to be installed in a 1/4" hole, so verify the holes are 1/4" and any flash is removed from the area.
6. Obtain two large metal rubber coated **J-Clamps "KKK"** and attach them to the Center Stack Support Surface (see photo #3) with two 1/4" Screws "LLL" and two Nuts "JJJ". Again make sure the holes in the Dash are 1/4" and there is no metal flash around the holes.
7. Obtain the small rubber coated **J-Clamp "MMM"** and attach it to the Dash Panel near the Headlight Switch (see photo #2). Use a 1/4" screw "LLL" and lock nut "JJJ" to hold the Clamp in place.

8. Obtain one large metal rubber coated **J-Clamp "KKK"** and attach it to the original Wiper Switch/ Cigar Lighter Bracket in place of the original 1 1/4" Wraparound Clip (see photo #4). Use Screw "LLL" and Nut "JJJ" to attach this large J Clamp. Attach the Wiper Switch/Cigar Lighter Bracket to the Dash Panel by attaching the new Wiper Switch 510668 to the Bracket using your original Wiper Switch Bezel, Retaining Nut, and Knob. Also attach the Cigar Lighter Assembly (not provided in this kit) to the Bracket using your original Cigar Lighter Receiver and Bezel. Install two **Illumination Light Jumper Harnesses "AA"** to the Wiper Switch/Cigar Lighter Bracket (requires a #1895 bulb, which is not included in this kit).

9. Attach the Headlight Switch Bracket to the Dash Panel by attaching the new **Headlight Switch 510385** to the bracket using your original Headlight Switch Bezel and Retaining Nut. A new Headlight Switch, Shaft, and Knob have been provided in this kit. Install one **Illumination Light Jumper Harness "AA"** to the Headlight Switch Bracket (requires a #1895 bulb, which is not included in this kit).

10. Obtain the large Grommet "VVV". Since this standard grommet is larger than required for this specific application, it will have to be modified slightly to fit in the existing Mustang Firewall Grommet hole. Remove a section from the grommet (see photo #5) and slide the grommet onto the main trunk of the Dash Harness between Circuit Branches #10 and #11 (see photo #6). Apply a piece of tape to the narrow end of the grommet, to help hold it in place during installation in the firewall.

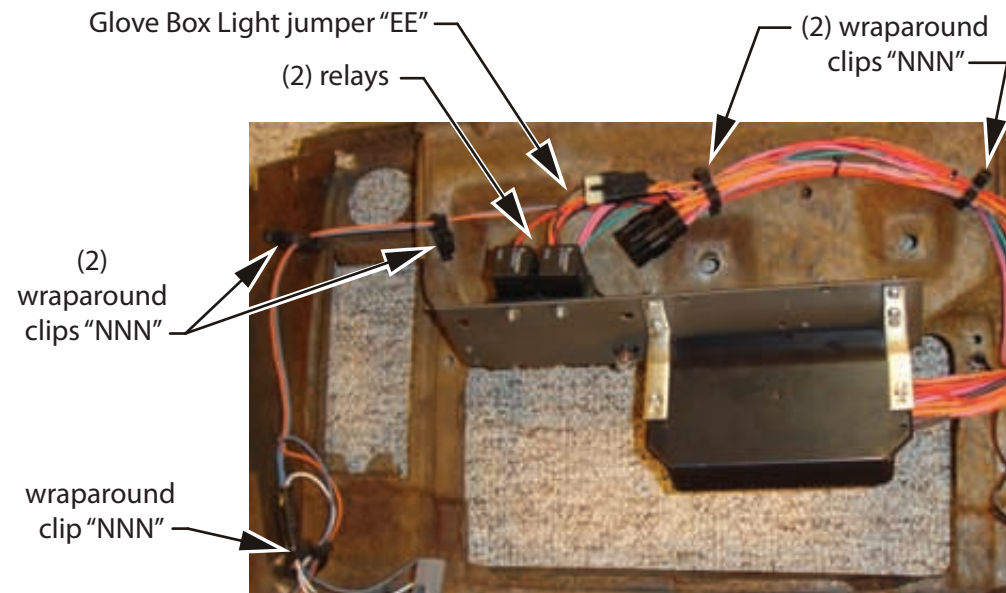

Photo #1

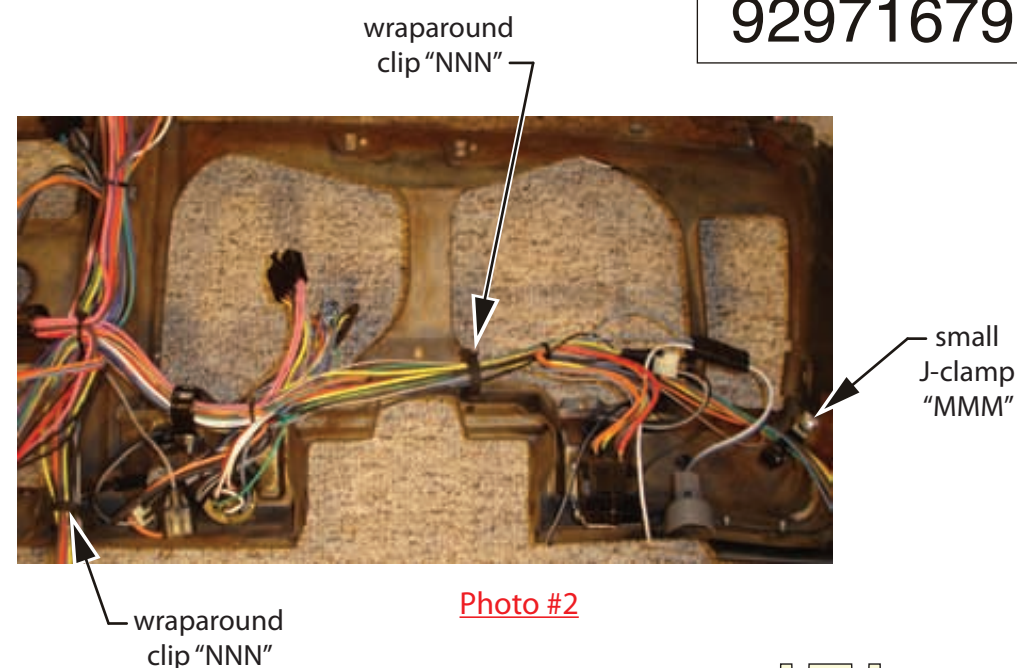

Photo #2

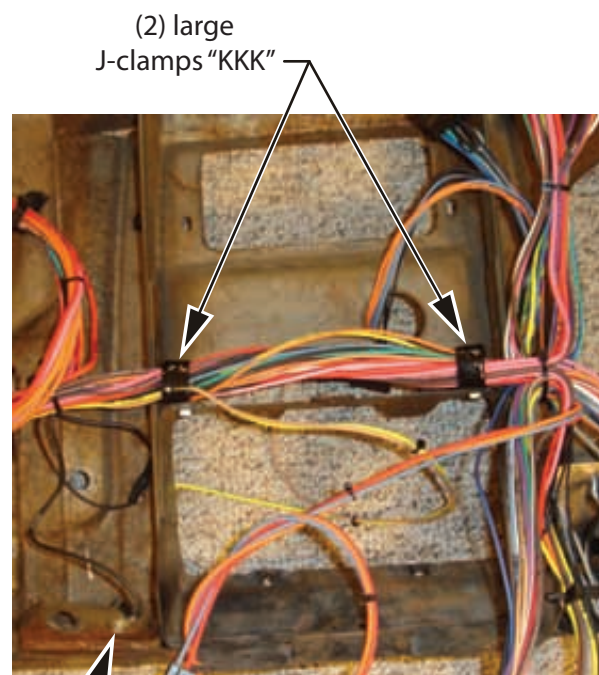

Photo #3

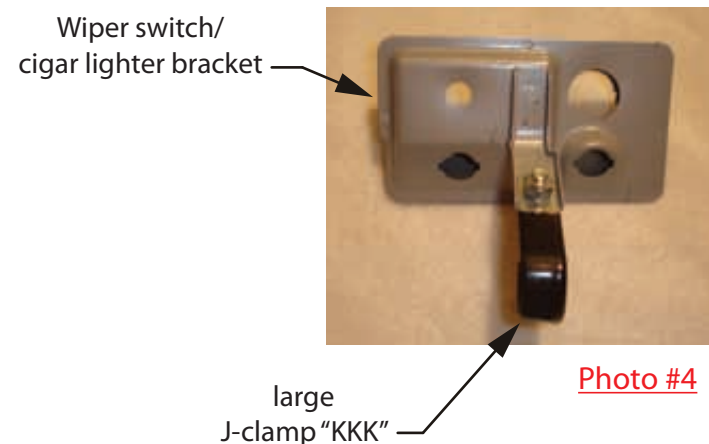
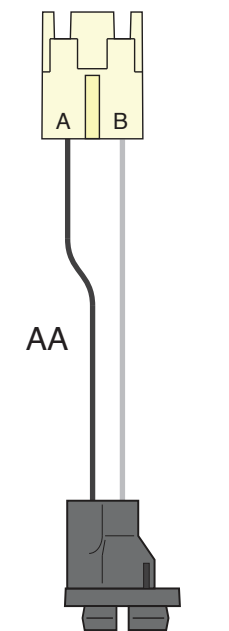

Photo #4



(Illumination Light Jumper)

ground ring terminal connection



Photo #5

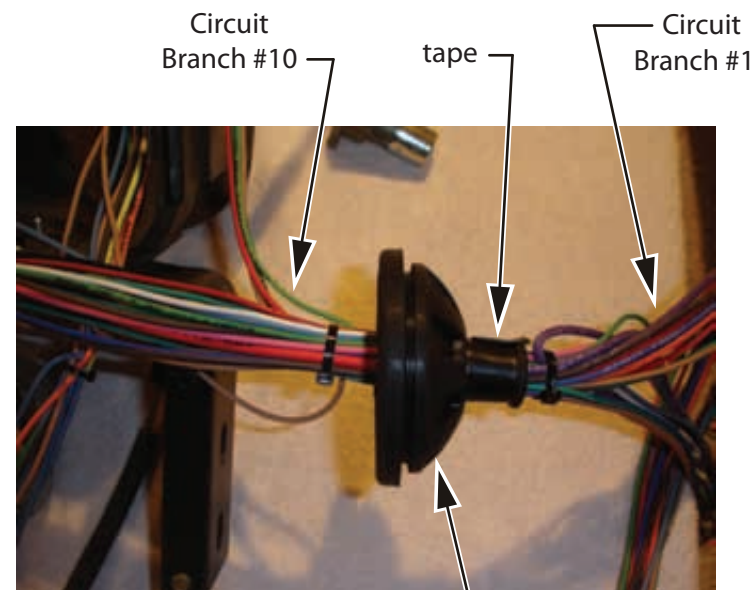

Photo #6



www.americanautowire.com 856-933-0801

MAIN HARNESS
1971-73 Ford Mustang
Classic Update Series

510662
Rev 1.0 7/21/2017 JM

92971679

Prior to installing the Dash Harness, obtain the Fuse, Flasher, and Relay Kit #510665 (located in Bag G) and plug all of the Fuses into the Fuse Block (see circuit branch #1), install the Flashers to the Dash Harness (see circuit branch #9) and install the Relays to the Dash Harness (see circuit branch #3).

Begin installing the Dash Harness to the Dash Panel. Attach the wiring to the Dash Panel beginning with Circuit Branch #1, then Circuit Branch #2, etc.

Under Dash Connections

Circuit Branch #1 – Under Dash Connections

1. Fuse Block, Relays and Glove Box Illumination Light

Remove your original Glove Box Relay Bracket and install the Dash Harness Fuse Block, the Relays and the Glove Box Illumination Light to this bracket (per the Fuse Block Mounting Instructions Template 92971696). Reinstall the Glove Box Relay Bracket, with the Fuse Block attached.

2. Accessory Connector

This connector and the mating connector are provided so that you can connect optional systems to the Dash Harness. Use the provided 6-way empty connector, which is attached to the 6-way Accessory connector on the Dash Harness, and terminals "DDD" and "EEE" to add power wires (not provided) for the following optional systems:

Accessory Connector

Wire #	Wire Color	Printing	Fuse #	Fuse Block Cover	Fuse rating	Description
100	Orange	no printing	7	Hazard	15A	Battery feed for Hazard or Audio Systems.
103	Tan	FUEL PUMP	10	Fuel Pump	20A	Ignition feed for an Electric Fuel Pump.
104	Orange	POWER SEATS	2	Pwr Seats	30A	Battery feed for Power Seats.
105	Red	POWER LOCKS	8	Pwr Locks	20A	Battery feed for Power Locks.
106	Pink	POWER WINDOWS	15	Pwr Window	30A	Accessory feed for Power Windows.
107	Orange	12V BATTERY FUSED	1	Bat-Spare	30A	Battery feed for options.

You can stow this branch in the Wraparound Clips "NNN".

Circuit Branch #2 – Under Dash Connections

1. Glove Box Light Switch Connector

Install the Glove Box Light Switch (not included) and connect.

Wire #	Wire Color	Printing	Description
152	Black/Red	no printing	Ground wire for the Glove Box Light.

2. Ground

Attach this black "GROUND" wire (circuit 150N) to the original ground location on the lower part of the Dash Panel (see photo #3).

Wire #	Wire Color	Printing	Description
150N	Black	GROUND	Ground wire.

3. Radio Wires

These wires are provided for your Radio.

Wire #	Wire Color	Printing	Description
43	Tan	RADIO	12V Fused Accessory Feed to the Radio for "On/Off" power.
99A	Yellow	RADIO BAT	12V Fused Battery Feed for Radio Memory.

Circuit Branch #3 – Under Dash Connections

1. Glove Box Light Connector

Plug the Glove Box Light Connector, which is part of the Dash Harness, to the Glove Box Light Jumper "EE" (see photo #1).

Wire #	Wire Color	Printing	Description
40F, G	Orange	12V BATTERY-FUSED	Fused Battery feed to the Glove Box Light.
152	Black/Red	no printing	Ground wire from the Glove Box Light to the Glove Box Light Switch.

2. Horn Relay Connector

Wire #	Wire Color	Printing	Description
2C	Red	12V BATTERY	Fused 12V Battery feed to the Horn Relay.
2K	Red	12V BATTERY	12V Battery feed to the Horn Relay Coil.
28	Black	HORN RELAY GROUND	Relay ground circuit to the Turn Signal Switch.
29	Dark Green	HORN	Feed to the Horns.

3. Ignition Switch Relay Connector

Wire #	Wire Color	Printing	Description
2D	Red	12V BATTERY	12V Battery feed to the Ignition Switch Relay.
2K	Red	12V BATTERY	12V Battery feed to the Horn Relay Coil.
3A	Pink	IGNITION FEED	Ignition feed to the Fuse Block.
3E	Pink	12V IGNITION	Ignition trigger wire from Ignition Switch.
150K	Black	GROUND	Ignition Circuit Relay ground.

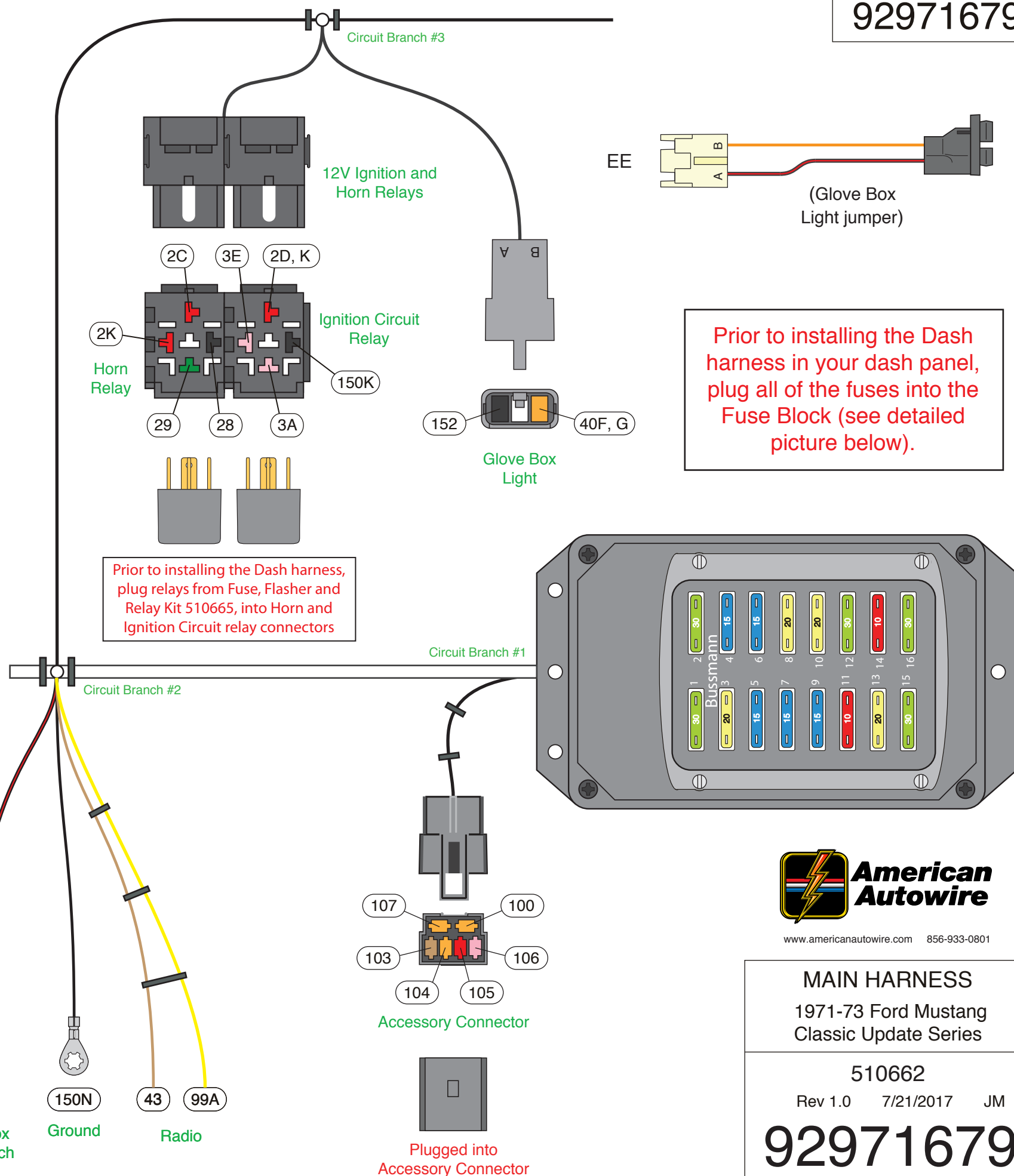

Prior to installing the Dash harness in your dash panel, plug all of the fuses into the Fuse Block (see detailed picture below).

Prior to installing the Dash harness, plug relays from Fuse, Flasher and Relay Kit 510665, into Horn and Ignition Circuit relay connectors



www.americanautowire.com 856-933-0801

MAIN HARNESS
 1971-73 Ford Mustang
 Classic Update Series

510662
 Rev 1.0 7/21/2017 JM

92971679

Circuit Branch #4 – Under Dash Connections

1. Right Hand Door Jamb Switch Connectors

After all of the Dash Harness Wiring is attached to the Dash Panel and the Dash Panel is installed in the car, route the two male bullet connectors into the Side Cowl and through the Door Jamb Switch Hole and connect to the **Door Jamb Switch "UUU"**; polarity does not matter. Install the new Door Jamb Switch in the original Door Jamb Switch location.

Wire #	Wire Color	Printing	Description
40G	Orange	12V BATTERY-FUSED	12V fused Battery feed.
53H	Light Blue	12V CTSY SW	Feed to the RH Courtesy Light.

RH Courtesy Light/Wiring Assembly

Attach the **Courtesy Light/Wiring Assembly "BB"** to the RH lower outboard Dash Panel (**requires a #631 Bulb which is not included in this kit**).

2. Right Hand Courtesy Light Connector

Plug the Right Hand Courtesy Light Connector to "BB".

Wire #	Wire Color	Printing	Description
53G, H	Light Blue	12V CTSY SW	12V Switched feed to the RH Courtesy Light.
156B	White	CTSY GROUND	RH Courtesy Light ground. Attach this ring terminal to a good ground.

Circuit Branch #5 – Under Dash Connections

Map Light Pigtail (optional)

Replace your 3-way molded connector on the Map Light Pigtail with a 4-way connector "PPP". Terminals "BBB" are to be crimped onto the pigtail wires. Align the wires as shown below:

Function	Ford Wire Color	AAW Wire#	AAW Wire Color
B+	Lt Green/Yellow	40	Orange
CTSY Gnd	Black/Lt Blue	156	White
Ground	Black	150	Black

1. Map Light Connector

After all of the Dash Harness Wiring is attached to the Dash Panel and the Dash Panel is installed in the car, plug the Map Light Connector to the Map Light Pigtail.

Wire #	Wire Color	Printing	Description
40A, B	Orange	12V BATTERY-FUSED	B+ feed to the Map Light.
53F, G	Light Blue	12V CTSY SW	Courtesy Switch wires.
150E,F	Black	GROUND	Ground.

Gauge Pack Jumper Harness

If you have the Gauge Pack option, attach the **Gauge Pack Jumper Harness "DD"** to the Gauge Pack. Attach the two Light Sockets (**requires #1895 Bulbs which are not included in this kit**) to the Gauge Pack Housing. Attach the four wire connections to the Gauges per the list below. **Note: There are no wires for an Ammeter.**

Gauge	Function	AAW Wire Color	Identifier on Gauge Pack Housing
Oil Pressure	Voltage In	Orange/Black	BK-GN
Oil Pressure	Oil Pressure	Dark Blue	WH-RED
Water Temp	Voltage In	Orange/Black	BK-GN
Water Temp	Water Temp	Dark Green	RED-WH

2. Gauge Pack Connector

After all of the Dash Harness Wiring is attached to the Dash Panel and the Dash Panel is installed in the car, plug the Gauge Pack Connector, which is part of the Dash Harness, to the **Gauge Pack Jumper Harness "DD"**.

Wire #	Wire Color	Printing	Description
8E, F	Gray	DASH LIGHTS	Feed to the Gauge Pack Illumination Light.
8F, H	Gray	DASH LIGHTS	Feed to the Gauge Pack Illumination Light.
31, 31A	Dark Blue	OIL PRESSURE SENDER	Oil Pressure Sender.
35, 35A	Dark Green	WATER TEMP SENDER	Water Temperature Sender.
60	Orange/Black	no printing	Voltage feed to the gauges.
150F,G	Black	GROUND	Ground for the Gauge Pack Illumination Light.
150G,H	Black	GROUND	Ground for the Gauge Pack Illumination Light.

3. Dash Light Candelabra

This 3-way female bullet connector provides a connection point for any extra Illumination Light feed that may be required, such as to the Radio, the Ash Tray Light, the PRNDL Light or any Aftermarket Gauges. This is the same circuit as the Instrument Cluster Illumination Lights and will dim when the Headlight Dimmer Switch Knob is rotated clockwise. Extra wire length of the gray "DASH LIGHTS" wire (circuit 8) is available in the **Cluster Kit 510664 in Bag H**. Also, large male bullet terminals "SSS" and large sleeves "TTT" (to plug into the Candelabra Connector) are available for this application.

Wire #	Wire Color	Printing	Description
8G	Gray	DASH LIGHTS	Dash Lights feed wire.

4. Blower Motor Resistor Connector

After all of the Dash Harness Wiring is attached to the Dash Panel and the Dash Panel is installed in the car, plug the Blower Motor Resistor connector to the Blower Motor Resistor. This is for Heater only cars.

Wire #	Wire Color	Printing	Description
51	Red	no printing	Blower Motor Resistor Low Speed.
52	Orange	no printing	Blower Motor Resistor High Speed.
72	Light Blue	no printing	Blower Motor Resistor Medium Speed.

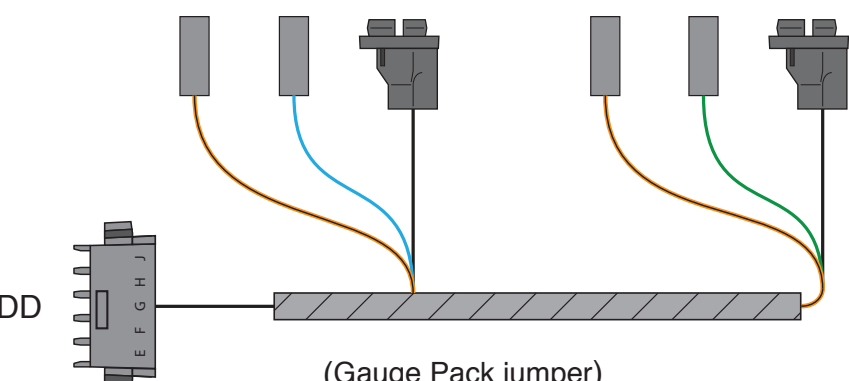
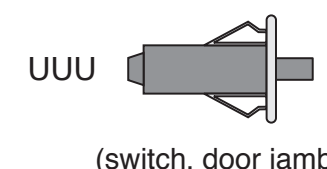
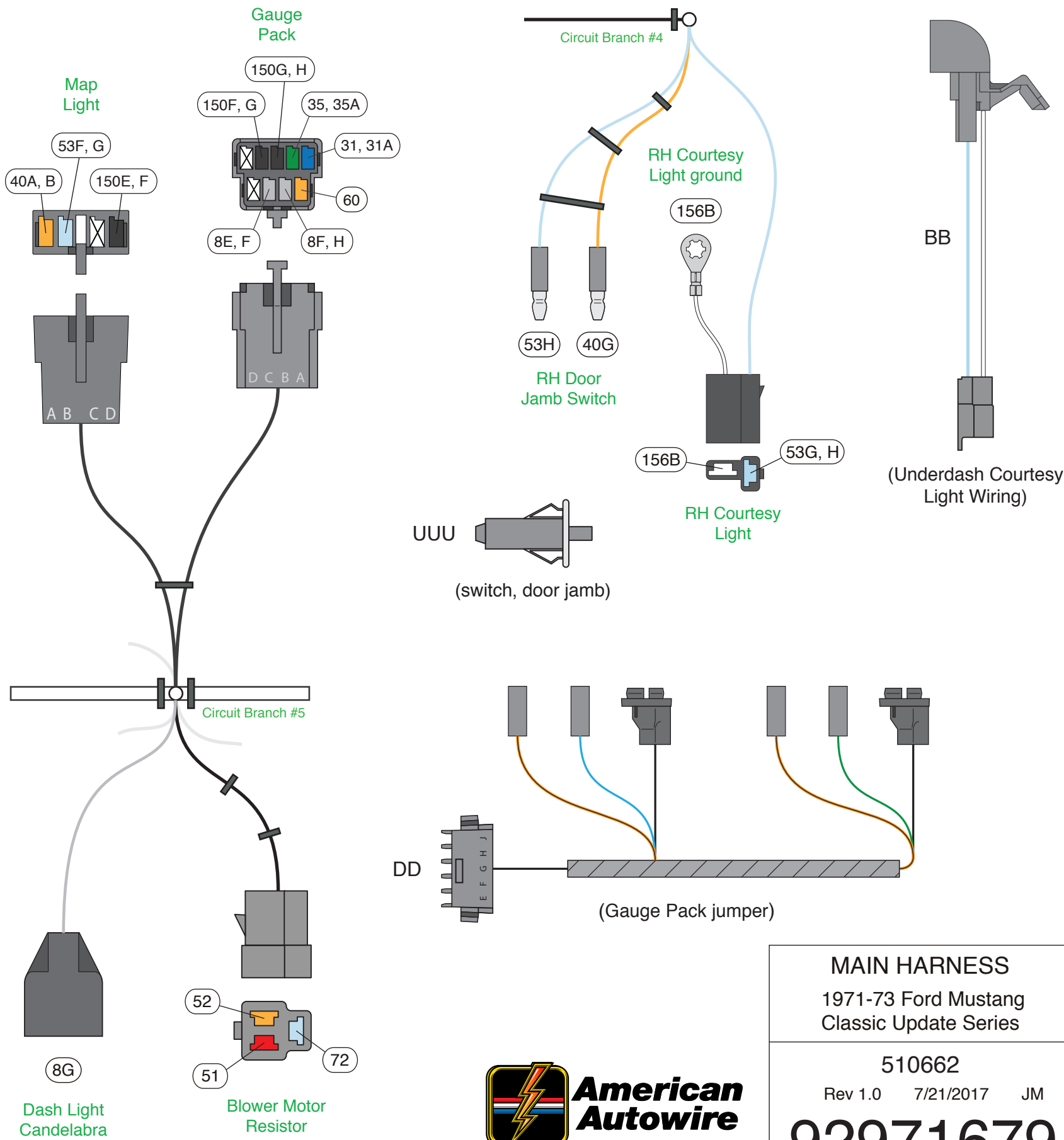

MAIN HARNESS
1971-73 Ford Mustang
Classic Update Series

510662
Rev 1.0 7/21/2017 JM
92971679



Circuit Branch #5 (continued)

Turn Signal Switch Pigtail Preparation

If you are using the original Turn Signal Switch you will have to remove the original connector (and terminals) and replace them with the 14-way connector "AAA", and terminals "BBB". Cut the original connector from the pigtail as close as possible to the original connector allowing maximum wire length, crimp on terminals "BBB" and plug into connector "AAA" (see Diagram 'A' and "Table A" on page 20 for wire location and a cross reference of the circuits).

If you are using an Aftermarket Steering Column it may already have the matching 14-way Pack con connector attached to the Turn Signal Switch Pigtail. If so, you can plug the Dash Harness 11-way connector directly into the Turn Signal Switch. If not, then add terminals "BBB" and connector "AAA" to the Turn Signal Switch.

5. Turn Signal Switch Connector

After all of the Dash Harness Wiring is attached to the Dash Panel and the Dash Panel is installed in the car, plug the 11-way Turn Signal Switch Connector, which is part of the Dash Harness, to the 14-way connector of the Turn Signal Switch.

Wire #	Wire Color	Printing	Description
14	Light Blue	LEFT DASH IND	Feed to the LH Turn Signal Indicator.
14A	Light Blue	LEFT FRONT TURN	Left Front Turn Signal feed.
15	Dark Blue	RIGHT DASH IND	Feed to the RH Turn Signal Indicator.
15A	Dark Blue	RIGHT FRONT TURN	Right Front Turn Signal feed.
16	Purple	TURN SWITCH FEED	Turn Signal Switch feed from the Turn Signal Flasher.
17	White	BRAKE SW	Brake Switch feed to the Turn Signal Switch.
18	Yellow	LEFT REAR TURN	Feed to the Left Rear Turn Signal Light.
19	Dark Green	RIGHT REAR TURN	Feed to the Right Rear Turn Signal Light.
27	Brown	TURN SW – HAZARD	Feed from the Hazard Flasher.
28	Black	HORN RELAY GROUND	Ground from the Horn Relay to the Horn Switch.
28A	Black	HORN RELAY GROUND	Ground from the Horn Switch to Ground.

Ignition Switch Pigtail Preparation

You will have to replace the black 8-way connector on the original Ignition Switch Pigtail with the AAW 6-way black connector "CCC". This connector will mate with the 6-way white Ignition Switch Connector of the Dash Harness. Crimp on terminal "DDD" for the thinner wires and terminal "EEE" for the thicker wires (see "Table B" on page 20 for wire location and description of the circuits).

6. Ignition Switch Connector

After all of the Dash Harness Wiring is attached to the Dash Panel and the Dash Panel is installed in the car, plug the Ignition Switch Connector to the Ignition Switch Pigtail connector "CCC".

Wire #	Wire Color	Printing	Description
2B	Red	12V BATTERY	12V Battery feed to the Ignition Switch.
3E	Pink	IGNITION FEED	12V Ignition feed from the Ignition Switch.
4A, 4E	Brown	IGNITION SW ACCY	12V Accessory feed from the Ignition Switch.
5	Brown/White	no printing	Accessory feed to the Cluster.
33C, D	Purple	NEUTRAL SAFETY SWITCH	Start feed to the Neutral Safety Switch or to the purple Starter Solenoid wire (circuit 6).
150M, N	Tan	BRAKE LIGHT/SWITCH	Brake Light prove-out during crank.
	Black	GROUND	Ground for Brake Light prove out.

Floor Console Clock Jumper

If you have the Floor Console Clock option, attach the Floor Console Clock Jumper Harness "CC" to the Clock. Attach the two Light Sockets (requires #1895 Bulbs which are not included in this kit) to the Clock Housing. Attach the brown connector to the Clock.

7. Floor Console Clock Connector

After all of the Dash Harness Wiring is attached to the Dash Panel and the Dash Panel is installed in the car, plug the Floor Console Clock Connector to the Floor Console Clock Jumper Harness "CC".

Wire #	Wire Color	Printing	Description
8H, J	Gray	DASH LIGHTS	Feed to the Clock Illumination lights.
99B, C	Yellow	CLOCK BAT	B+ feed to the Clock.
150J, K	Black	GROUND	Ground for the Clock.

Heater Switch Illumination Light Jumper

Attach the Heater Switch Illumination Light Jumper "AA" to the Heater Switch Control Panel (requires a #1445 Bulb which is not included in this kit).

8. Heater Switch Illumination Light Connector

After all of the Dash Harness Wiring is attached to the Dash Panel and the Dash Panel is installed in the car, plug the Heater Switch Illumination Light Connector to the Jumper Harness "AA".

Wire #	Wire Color	Printing	Description
8J, G	Gray	DASH LIGHTS	Feed to the Heater Control Panel Illumination Light.
150H, J	Black	GROUND	Ground for the Heater Control Panel Illumination Light.

9. Heater Switch Connector

After all of the Dash Harness Wiring is attached to the Dash Panel and the Dash Panel is installed in the car, plug the Heater Switch Connector to the Heater Switch.

Wire #	Wire Color	Printing	Description
50	Brown	HEATER/AC FEED	Fused 12V to the Heater Switch.
51	Red	no printing	Heater Switch to Blower Motor Low Speed.
52	Orange	no printing	Heater Switch to Blower Motor High Speed.
72	Light Blue	no printing	Heater Switch to Blower Motor Medium Speed.

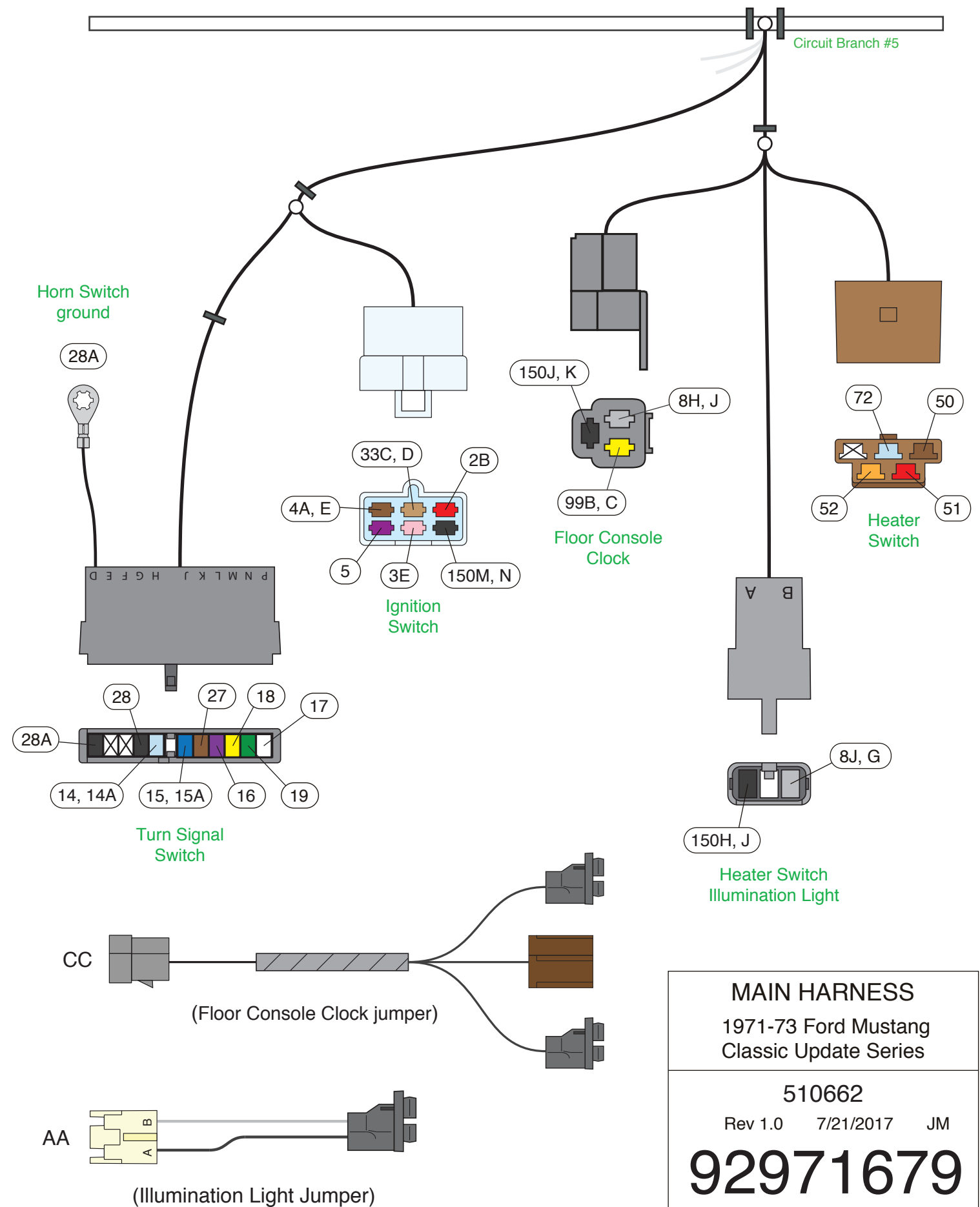

MAIN HARNESS
 1971-73 Ford Mustang
 Classic Update Series

510662
 Rev 1.0 7/21/2017 JM

92971679



Circuit Branch #6 – Under Dash Connections

Instrument Cluster Connections

These connectors will plug to the connectors of the **Gauge Cluster Kit 510664** (located in Bag H).



www.americanautowire.com 856-933-0801

92971679

1. Cluster Connector "A"

Wire #	Wire Color	Printing	Description
4E	Brown/White	no printing	12V Ignition Accessory feed.
8D, E	Gray	DASH LIGHTS	Feed for the Cluster Illumination Lights.
39A, B	Pink	12V IGNITION	12V Fused Ignition feed.
60	Orange/Black	no printing	Reduced Voltage output from the CVR for the Gauge Pack.
99C	Yellow	CLOCK BAT	B+ feed to the Cluster Clock.
150C, D	Black	GROUND	Cluster ground.

2. Cluster Connector "C"

This connector contains the wires for an Aftermarket Electric Speedometer. **NOTE: Wires "400" and "401" must remain twisted together.**

Wire #	Wire Color	Printing	Description
139	Pink/White	SPEEDO POWER	Fused 12V Ignition feed for the Electric Speedometer.
151	Black/White	SPEEDO GROUND	Electric Speedometer Ground.
400	Yellow	VSS GROUND	Vehicle Speed Sensor Ground.
401	Purple	VSS SIGNAL	Vehicle Speed Sensor Signal.
402	Purple/White	VSS POWER	Vehicle Speed Sensor Power.

3. Cluster Connector "B"

Wire #	Wire Color	Printing	Description
11	Light Green	HI BEAM INDICATOR LIGHT	Feed to the High Beam Indicator Light.
14	Light Blue	LEFT DASH IND	Feed for the Left Turn Signal Indicator Light.
15	Dark Blue	RIGHT DASH IND	Feed for the Right Turn Signal Indicator Light.
30	Tan	GAS GAUGE	Fuel Gauge Signal from the Fuel Tank Sending Unit.
31	Dark Blue	OIL PRESSURE SENDER	Oil Pressure Sender Signal from the Engine.
33D	Tan	BRAKE LIGHT/SWITCH	Brake Warning Light Signal to ground.
35	Dark Green	WATER TEMP SENDER	Water Temperature Sender Signal from the Engine.
121	White	COIL -> TACH	Tachometer Feed Signal from the Ignition Coil or an Aftermarket Module.

4. Wiper Switch Illumination Light Connector

Connect the Wiper Switch Illumination Light connector to **Jumper "AA"**.

Wire #	Wire Color	Printing	Description
8B, C	Gray	DASH LIGHTS	Feed to the Wiper Switch Illumination Light.
150B, C	Black	GROUND	Ground for the Wiper Switch Illumination Light.

5. Cigar Lighter Illumination Light Connector

Connect the Cigar Lighter Illumination Light Connector to **Jumper "AA"**.

Wire #	Wire Color	Printing	Description
8C, D	Gray	DASH LIGHTS	Feed to the Cigar Lighter Illumination Light.
150A, B	Black	GROUND	Ground for the Cigar lighter Illumination Light.

6. Wiper Switch Connector

Plug the Wiper Switch Connector to the Wiper Switch.

Wire #	Wire Color	Printing	Description
91W	White	no printing	Switched 12V out for wiper low speed.
92W	Dark Blue	no printing	Switched 12V out for wiper high speed.
93, 93A	White	WIPER FEED	12V fused feed for Wiper Switch Assembly.
93A	White	WIPER FEED	12V fused feed for the Washer Pump lead.
94	Dark Green	no printing	Switched 12V out for the Washer Pump.
95W	Black	no printing	Wiper Motor park.
96W	Red	no printing	Wiper Motor low park.

7. Cigar Lighter Connector

Plug the Cigar Lighter female bullet connector to the Cigar Lighter.

Wire #	Wire Color	Printing	Description
40H	Orange	12V BATTERY-FUSED	B+ feed to the Cigar Lighter.

8. Cigar Lighter Ground Connector

Plug the ground connector to the Cigar Lighter Ground.

Wire #	Wire Color	Printing	Description
150A	Black	GROUND	Ground for the Illumination Lights.
150E	Black	GROUND	Ground for the Map Lights.
150M	Black	GROUND	Ground for the Ignition Switch.

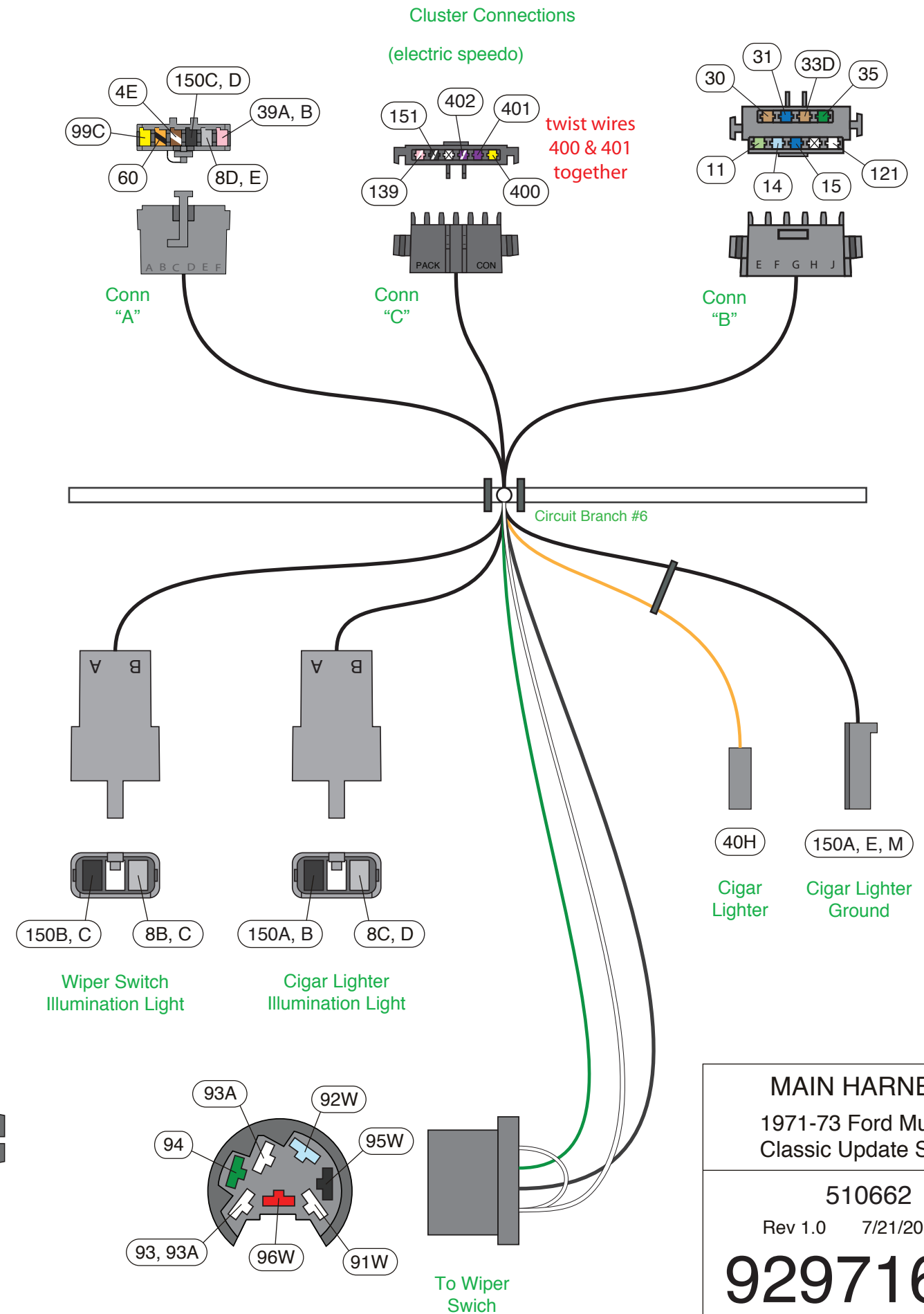

MAIN HARNESS
 1971-73 Ford Mustang
 Classic Update Series

510662
 Rev 1.0 7/21/2017 JM

92971679

Circuit Branch #7 – Under Dash Connections

LH Courtesy Light/Wiring Assembly

Attach the **Courtesy Light/Wiring Assembly “BB”** to the LH lower outboard Dash Panel (**requires a #631 Bulb which is not included in this kit**).

1. Left Hand Courtesy Light Connector

Plug the Left Hand Courtesy Light Connector to “BB”.

Wire #	Wire Color	Printing	Description
53A, B	Light Blue	12V CTSY SW	12V Switched feed to the LH Courtesy Light.
156A	White	CTSY GROUND	LH Courtesy Light ground. Attach this ring terminal to a good ground.

2. Aftermarket Electric Speedo Ground

Attach this wire to a Dash Panel ground location near the Headlight Switch.

Note: Do not attach this ground wire (circuit 151) with any other ground wire . This wire should remain separate from all other grounds.

Wire #	Wire Color	Printing	Description
151	Black/White	SPEEDO GROUND	Ground for an Aftermarket Electric Speedometer.

3. Headlight Switch Illumination Light Connector

Connect the Headlight Switch Illumination Light connector to **Jumper “AA”**.

Wire #	Wire Color	Printing	Description
8A, B	Gray	DASH LIGHTS	Feed to the Headlight Switch Illumination Light.
150D	Black	GROUND	Ground for the Headlight Switch Illumination Light.

4. Headlight Switch Connector

Plug the Headlight Switch Connector to the Headlight Switch.

Wire #	Wire Color	Printing	Description
2F	Red	12V BATTERY	12V Battery feed from the Fuse Block.
8A	Gray	DASH LIGHTS	Dash Light feed for the Dash Lights.
9	Brown	PARK LIGHTS	Feed to the Front Park Lights.
9A	Brown	REAR RUNNING LIGHTS	Feed to the Rear Tail Lights and the License Light.
10	Yellow	DIMMER SW FEED	Feed to the Headlight Dimmer Switch for the Headlights.
40B	Orange	12V BATTERY-FUSED	Fused 12V Battery feed from the Fuse Block.
40C	Orange	12V BATTERY-FUSED	Fused 12V Battery feed to the LH Door Jamb Switch.
40D	Orange	12V BATTERY-FUSED	Fused 12V Battery feed to the Rear Body Harness.
53A	Light Blue	12V CTSY SW	12V Switched feed to the LH Courtesy Light.
53F	Light Blue	12V CTSY SW	12V Switched feed to the Map Light.

Circuit Branch #8 – Under Dash Connections

1. Left Hand Door Jamb Switch Connectors

After all of the Dash Harness Wiring is attached to the Dash Panel and the Dash Panel is installed in the car, route the two male bullet connectors into the Side Cowl and through the Door Jamb Switch Hole and connect to the **Door Jamb Switch “UUU”**. Polarity does not matter. Install the new Door Jamb Switch in the original Door Jamb Switch location.

Wire #	Wire Color	Printing	Description
40C	Orange	12V BATTERY-FUSED	12V fused Battery feed.
53C	Light Blue	12V CTSY SW	Feed to the LH Courtesy Light.

2. Rear Body Connector

After all of the Dash Harness Wiring is attached to the Dash Panel and the Dash Panel is installed in the car, plug the Rear Body Harness Connector (**included in the Rear Body Harness Kit 510667 in Bag M**) to the Dash Harness Rear Body Connector.

Wire #	Wire Color	Printing	Description
9A	Brown	REAR RUNNING LIGHTS	Feed for the Side Marker Lights, the License Light and the Rear Running Lights.
17	White	BRAKE SW	Feed for the Brake Switch.
17A	Light Blue	THIRD BRAKE LIGHT	Feed for an aftermarket Third Brake Light.
18	Yellow	LEFT REAR TURN	Feed to the Left Rear Stop and Turn Light.
19	Dark Green	RIGHT REAR TURN	Feed to the Right Rear Stop and Turn Light.
24	Light Green	BACK UP LT SW -> LIGHTS	Feed from the Back-up Light Switch to the Back-up Lights.
30	Tan	GAS GAUGE	Fuel Tank Sender.
40D	Orange	12V BATTERY-FUSED	12V Fused Battery feed for a Trunk Light or Aftermarket LED Tail Lights.
53B, C	Light Blue	12V CTSY SW	12V Switched feed for the Dome Light.

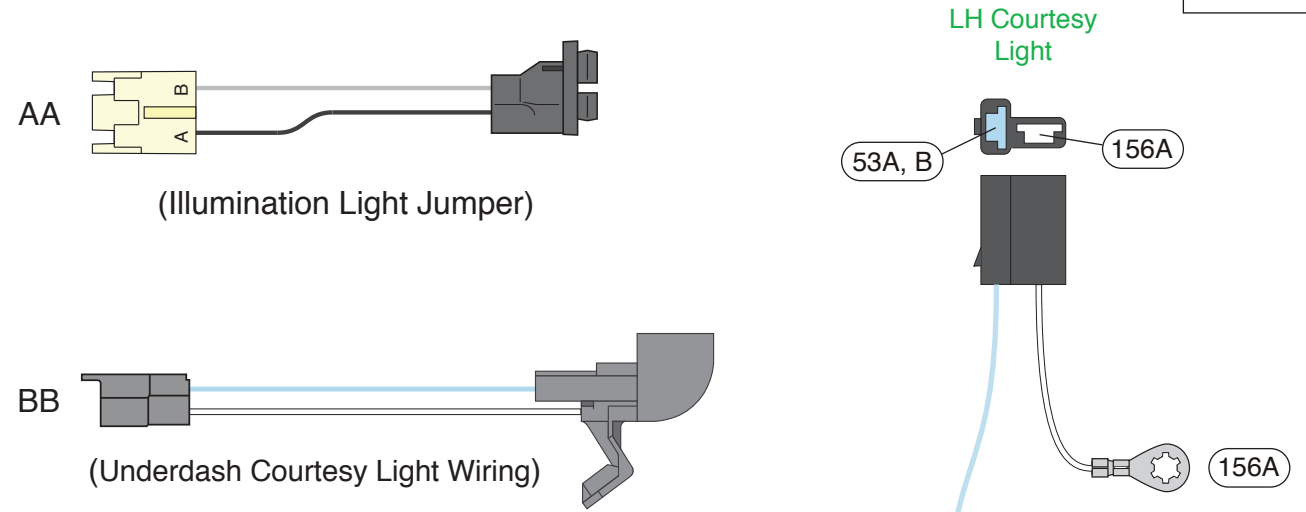

www.americanautowire.com 856-933-0801

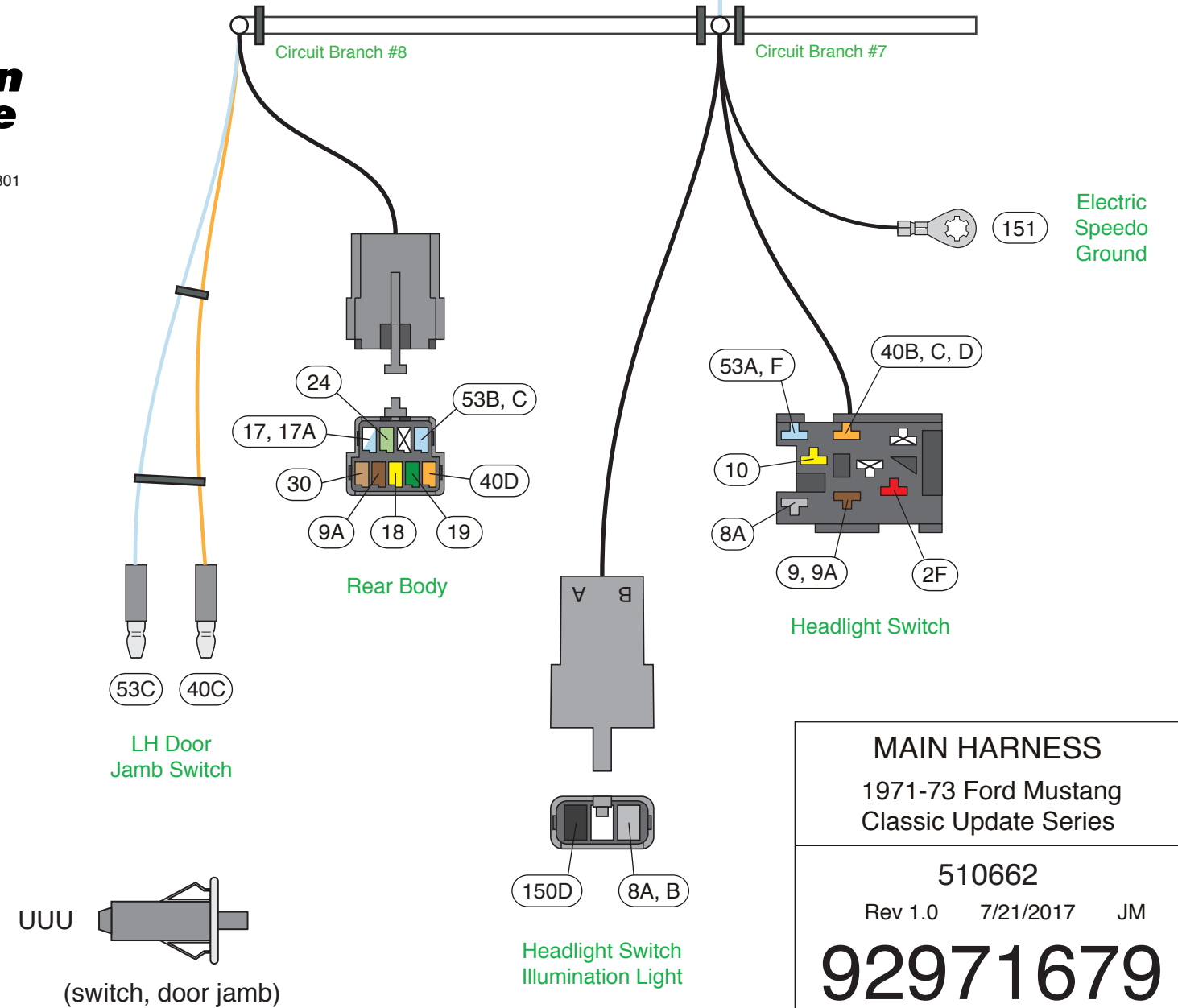

MAIN HARNESS
 1971-73 Ford Mustang
 Classic Update Series

510662
 Rev 1.0 7/21/2017 JM

92971679

Install the Dash Panel to the Car. Route the Engine Compartment Wire Harness Branches over the Steering Column Bracket and above the Park Brake Assembly and through the hole in the Firewall to the Engine Compartment. This is the same wire routing as the original routing.

Circuit Branch #9 – Under Dash Connections

1. Brake Switch Connector

Plug the Brake Switch Connector to the Stop Light Brake Switch.

Wire #	Wire Color	Printing	Description
17A	White	THIRD BRAKE LIGHT	Brake Switch feed to the Turn Signal Switch.
40E	Orange	BRAKE SW	2V Battery Fused feed from the Fuse Block.

2. Turn Flasher Connector

If you haven't already; plug one of the Flashers into this connector.

Wire #	Wire Color	Printing	Description
16	Purple	TURNOFF SW FEED	12V feed from the Turn Flasher to the Turn Signal Switch.
16A	Purple	TURNOFF SW FEED	12V Ignition feed from the Fuse Block.

3. Hazard Flasher Connector

If you haven't already; plug one of the Flashers into this connector.

Wire #	Wire Color	Printing	Description
27	Brown	TURNOFF SW-HAZARD	12V feed from the Hazard Flasher to the Turn Signal Switch.
27A	Brown	TURNOFF SW-HAZARD	12V Battery feed from the Fuse Block.

Circuit Branch #10 – Under Dash Connections

1. Dimmer Switch Connector

Plug the 3-way Dimmer Switch Connector to the new Dimmer Switch 500042 (located in Bag G) and attach the Dimmer Switch to the Floor Pan.

Wire #	Wire Color	Printing	Description
10	Yellow	DIMMER SW FEED	Feed from the Headlight Switch.
10A	Red	no printing	Feed from the Dimmer Switch to the Grill Lights (1971-72 only).
11	Light Green	HI BEAM INDICATOR LIGHT	Feed to the High Beam Indicator Light in the Instrument Cluster.
11A	Light Green	HEADLIGHT-HI BEAM	Feed to the High Beam Headlights.
12	Tan	HEADLIGHT-LOW BEAM	Feed to the Low Beam Headlights.

2. Park Brake Switch Connector

Plug the Park Brake Switch Connector to the Park Brake Switch.

Wire #	Wire Color	Printing	Description
33B, C	Tan	BRAKE LIGHT/SWITCH	Brake Light ground wire to Park Brake Switch.

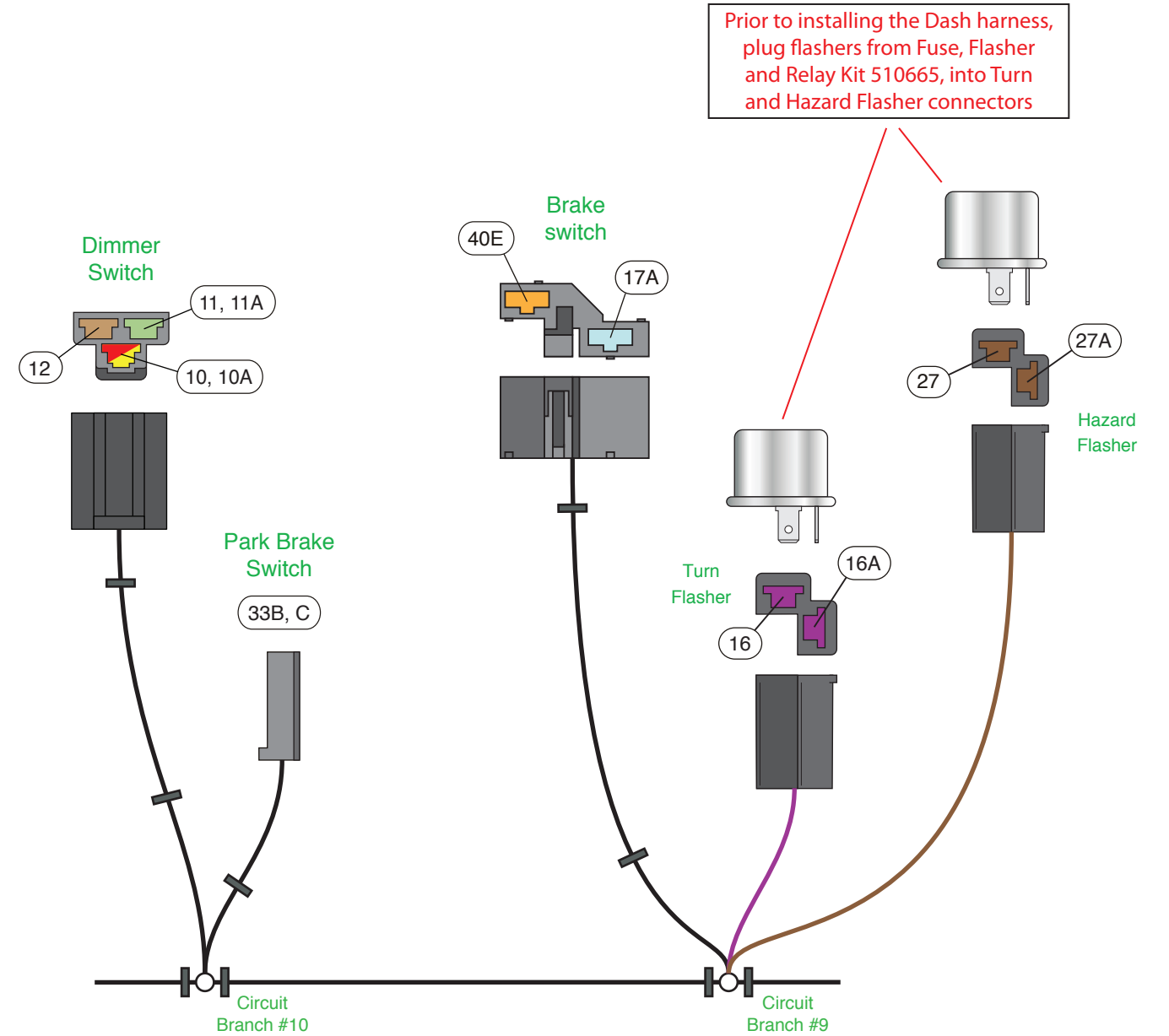

MAIN HARNESS
 1971-73 Ford Mustang
 Classic Update Series

510662
 Rev 1.0 7/21/2017 JM

92971679



Engine Compartment Connections

Since Grommet "VVV" is already installed on the Dash Harness, you can seat it in the Firewall hole. After all of the wiring is installed apply silicon sealer around the grommet to ensure a weather tight seal.

The wiring will split into two main segments similar to the original Headlamp and Dash Wire Harness routing. One segment will route forward to the Front Lighting (see Figure I) and the second main segment will route across the upper Firewall to the Engine (see Figure II).

Circuit Branches #11, #12, and #13 – Engine Compartment Connections (see Figures I and II)

Figure I (see page 18)

Route the branch with the Front Light Connections along the LH Inner Fender and then across the lower Radiator Support. Follow the path of the original routing. As an alternative, extra wire length has been provided if you wish to route the wiring between the Inner and Outer Fenders.

Brake Pressure Differential Switch

(NOTE:) We have provided you with the connection to the original Ford brake warning switch, in the form of **Brake Pressure Differential Warning Switch Extension "FF"**. You will plug this extension onto wire 33B, below.

1. Brake Pressure Differential Warning Switch Dash Harness Connection

Route this wire to the brake warning switch area near the master cylinder, cut to length, install terminal "C", plug into connector "B" as shown on page 18, figure I, then plug this wire into **Brake Pressure Differential Warning Switch Extension "FF"**, to complete your brake warning circuit.

Wire #	Wire Color	Printing	Description
33B	Tan	Brake Light/Switch	Brake Warning Switch.

2. Horn Wire Connection

Obtain the dark green "HORN" wire (circuit 29) from the Dash Harness and route the loose end of the wire to the first Horn and cut to length, double with the cutoff portion and crimp on terminal "D" and plug into connector "F". Route the loose wire to the second Horn (if so equipped), cut to length, crimp on terminal "C" and plug into connector "F".

Connect to the Horn.

Wire #	Wire Color	Printing	Description
29	Dark Green	HORN	Feed to the Horn.

3. Washer Pump

Obtain the Dark Green "no printing" wire (circuit 94) and route this wire to the Washer Pump and connect.

Wire #	Wire Color	Printing	Description
94	Dark Green	no printing	Feed to the Washer Pump.

4. Aftermarket Electric Fan Wire

This wire is a fused 12V Ignition feed wire which comes directly from the Fuse Block and is intended to be used as the relay trigger wire for an Electric Fan Relay. Route this orange "ELECTRIC FAN" wire (circuit 300) to a relay kit.

Note: An Optional Relay Kit (Universal Relay Kit 500479 or Universal Waterproof Relay Kit 500093) can be purchased from AAW. Connect per the instructions in the Relay Kit.

Wire #	Wire Color	Printing	Description
300	Orange	ELECTRIC FAN	Electric Fan Relay Feed.

FRONT LIGHTING

Headlights (see Figure "I" on page 18)

1. Low Beam Headlight Wire Connections

Obtain both of the **Headlight Jumper Harnesses "JJ"** and place them near each Headlight. Obtain the tan "HEADLIGHT-LOW BEAM" wire (circuit 12) from the Dash Harness and route the loose end of the wire to the **LH Jumper Harness "JJ"**, cut to length, double the tan wire with the tan wire that was just cut off, crimp on the large terminal "Q", and insert into the **LH Jumper Harness "JJ"**. Route the loose end of the tan wire to the **RH Headlight Harness "JJ"**, cut to length, crimp on the large terminal "P" and plug into the **RH Jumper Harness "JJ"**.

Wire #	Wire Color	Printing	Description
12	Tan	HEADLIGHT-LOW BEAM	Feed to the Low Beam Headlights.

2. High Beam Headlight Wire Connections

Obtain the light green "HEADLIGHT-HI BEAM" wire (circuit 11A) from the Dash Harness and route the loose end of the wire to the **LH Jumper Harness "JJ"**, cut to length, double the light green wire with the light green wire that was just cut off, crimp on the large terminal "Q", and insert into the **LH Jumper Harness "JJ"**. Route the loose end of the light green wire to the **RH Jumper Harness "JJ"**, cut to length, crimp on the large terminal "P" and plug into the **RH Jumper Harness "JJ"**.

Wire #	Wire Color	Printing	Description
11A	Light Green	HEADLIGHT-HI BEAM	Feed to the High Beam Headlights.

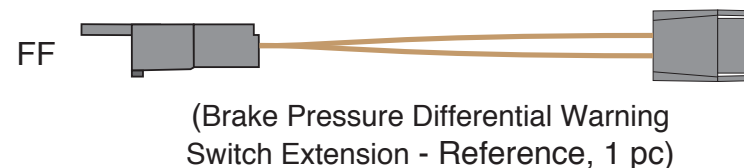
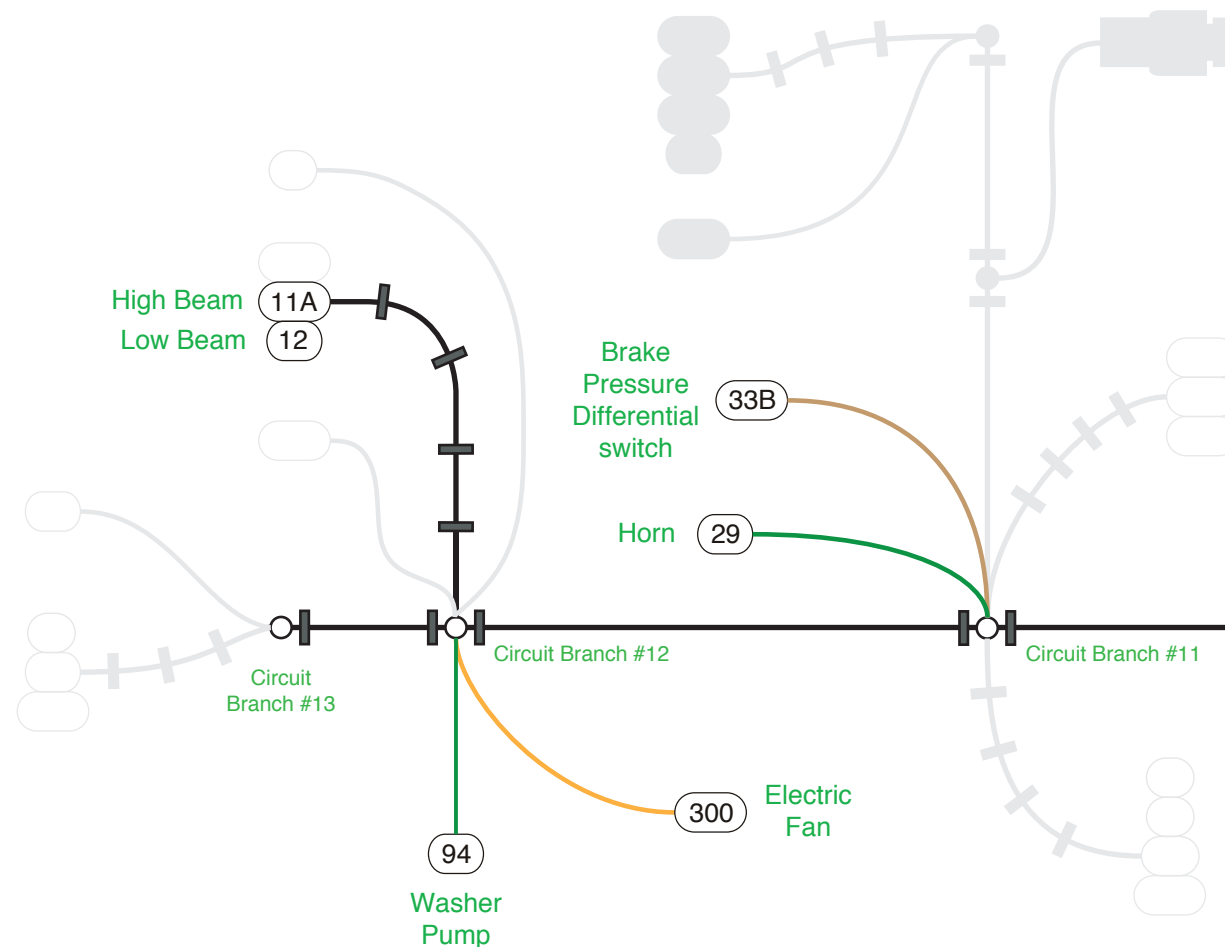
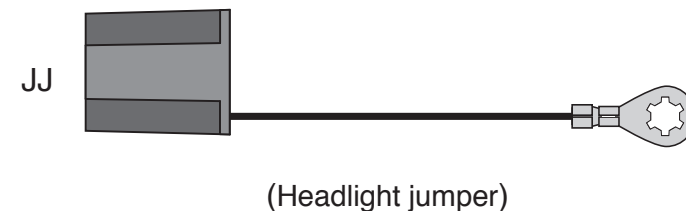

MAIN HARNESS
1971-73 Ford Mustang
Classic Update Series

510662
Rev 1.0 7/21/2017 JM

Figure I (continued, see page 18)

3. Headlight Ground Wire

For both the LH and the RH sides, obtain the black ground wire from each of the **Headlight Jumper Harnesses “JJ”** and attach each ring terminal to a good vehicle ground near each Headlight.

Park/Turn and Side Marker Lights (see Figure “I” on page 18)

Preparing the Parking Light Assemblies

For the **1971-72 vehicles** the Park/Turn Lights are below the Front Bumper. You will use your original Park/Turn Light Socket and Pigtail Assemblies but will have to replace the original 3-way molded pigtail connector with a 3-way connector “H” and terminals “J”. Cut the original molded connector from the Park/Turn Light pigtail and crimp on terminal “J” to each wire. Plug these “J” terminals into the 3-way connector “H”.

For the **1973 vehicles**, the Park/Turn Lights are the Grille Lights in the Grill. Obtain the **Front Park/Turn & Grill Light Jumper Harnesses “GG”**, (add a #1157 bulb not included in kit) and plug the **Jumper Harness “GG”** into the Park/Turn Light Housing.

Note that the wire function/colors are as follows:

LH Turn Signal – green/white (Ford) to light blue (AAW).

RH Turn Signal – white/blue (Ford) to dark blue (AAW).

Park Lights – black/yellow (Ford) to brown (AAW).

Ground – black (Ford) to black (AAW)

1. Side Marker Light/Park Light Wire Connections - Feed

For the Side Marker Light connections, obtain both of the **Front Side Marker Jumper Harnesses “HH”** and place them in vehicle position. Obtain the brown “PARK LIGHTS” wire (circuit 9) from the Main Dash Harness and route the loose end of this wire to the **LH Side Marker Jumper Harness “HH”**, cut to length and double this wire with the cutoff portion of the brown wire. Crimp on terminal “M” and plug into the **LH Side Marker Jumper Harness “HH”**.

Route the loose brown wire to the LH Park/Turn Signal Light pigtail. Cut to length, double this wire with the cutoff portion of the brown wire and crimp on terminal “D”. Plug terminal “D” into the 3-way connector “N”.

Route the cutoff portion of the brown wire to the RH Park/Turn Signal Light pigtail. Cut to length, double with the cutoff portion and crimp on terminal “D”. Plug terminal “D” into the other 3-way connector “N”. Route the loose brown wire to the **RH Front Side Marker Jumper Harness “HH”**, crimp on terminal “L” and plug into the **RH Side Marker Jumper Harness “HH”**.

Wire #	Wire Color	Printing	Description
9	Brown	PARK LIGHTS	Side Marker and Park Lights feed.

2. Side Marker Light/Park Light Wire Connections – Ground

Obtain the black “GROUND” wire that is part of the **LH Side Marker Jumper Harness “HH”**, and route the wire to the LH Park/Turn Light pigtail and cut to length. Ground the ring terminal end of the black wire that you just cut to a good vehicle ground. Route the loose end to the LH Park/Turn Light pigtail, cut to length, double this wire with the other black wire, crimp on terminal “D” and plug into connector “N”. Repeat this process for the RH Side Marker and RH Park/Turn Light pigtail.

3. LH Turn Signal Light Wire Connections

Obtain the light blue “LEFT FRONT TURN” wire (circuit 14A) from the Dash Harness and route the loose end of the wire to the LH Park/Turn Signal Light pigtail and cut to length, crimp on terminal “C” and insert into connector “N”.

Wire #	Wire Color	Printing	Description
14A	Light Blue	LEFT FRONT TURN	Feed to the LH Front Turn Signal Light.

4. RH Turn Signal Light Wire Connections

Obtain the dark blue “RIGHT FRONT TURN” wire (circuit 15A) from the Dash Harness and route the loose end of the wire to the RH Park/Turn Signal Light pigtail and cut to length, crimp on terminal “C” and insert into connector “N”.

Wire #	Wire Color	Printing	Description
15A	Dark Blue	RIGHT FRONT TURN	Feed to the RH Front Turn Signal Light.

Grill Lights (see Figure “I” on page 18)

For the **1973 vehicles**, the Grill Lights are the Park/Turn Lights (already covered above).

For the **1971-72 vehicles**, the Grill Lights act as running lights and are on when the Headlight Switch is on (see below).

When you use the Jumper Harness “GG” for the Park/Turn Lights, you will install a #1157 bulb. When you use Jumper Harness “GG” for the Grill Lights, you will install a #94 bulb; neither bulb is included in the kit.

1. Grill Lights

Obtain the **Front Park/Turn & Grill Light Jumper Harnesses “GG”**, (requires a #94 Bulb which is not included in this kit) and plug both of the **Jumper Harness “GG”** into the Grill Light Housings. Obtain the red “no printing” wire (circuit 10A) and route this wire to the **LH Jumper Harness “GG”**. Cut to length and double this wire with the cutoff portion, crimp on terminal “D” and plug into connector “N”. Route the loose red wire to the **RH Jumper Harness “GG”**, cut to length, crimp on terminal “C” and plug into the second connector “N”.

Obtain the white **Grill Light Ground Wire “PP”** and attach the ring terminal to a good vehicle ground near the LH Grille Light Assembly. Route the loose end of the white wire to the **LH connector “N”**, cut to length, crimp on terminal “C”. Plug into the connector “N”.

Repeat this process for the RH Grill Light Assembly.

Note: The black wire in the Front Park/Turn & Grill Light Jumper Harness “GG” is not connected for this application.

Wire #	Wire Color	Printing	Description
10A	Red	no printing	Feed to the Grille Lights.
156P	White	no printing	Ground for the Grille Lights.
156Q	White	no printing	Ground for the Grille Lights.

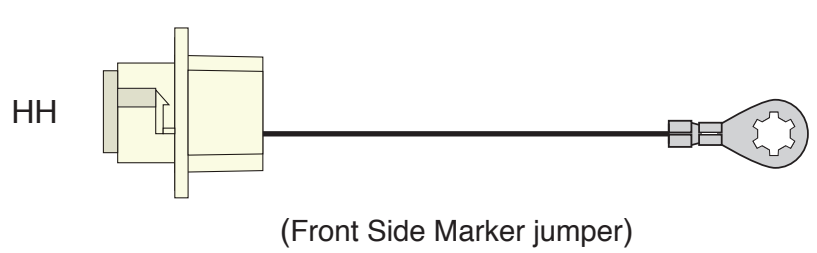
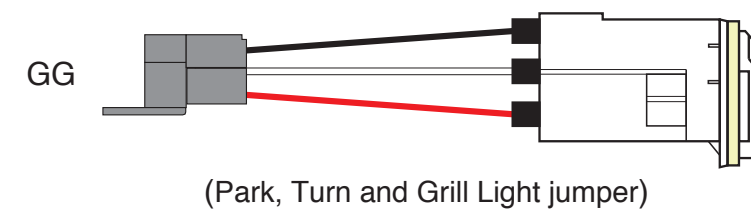
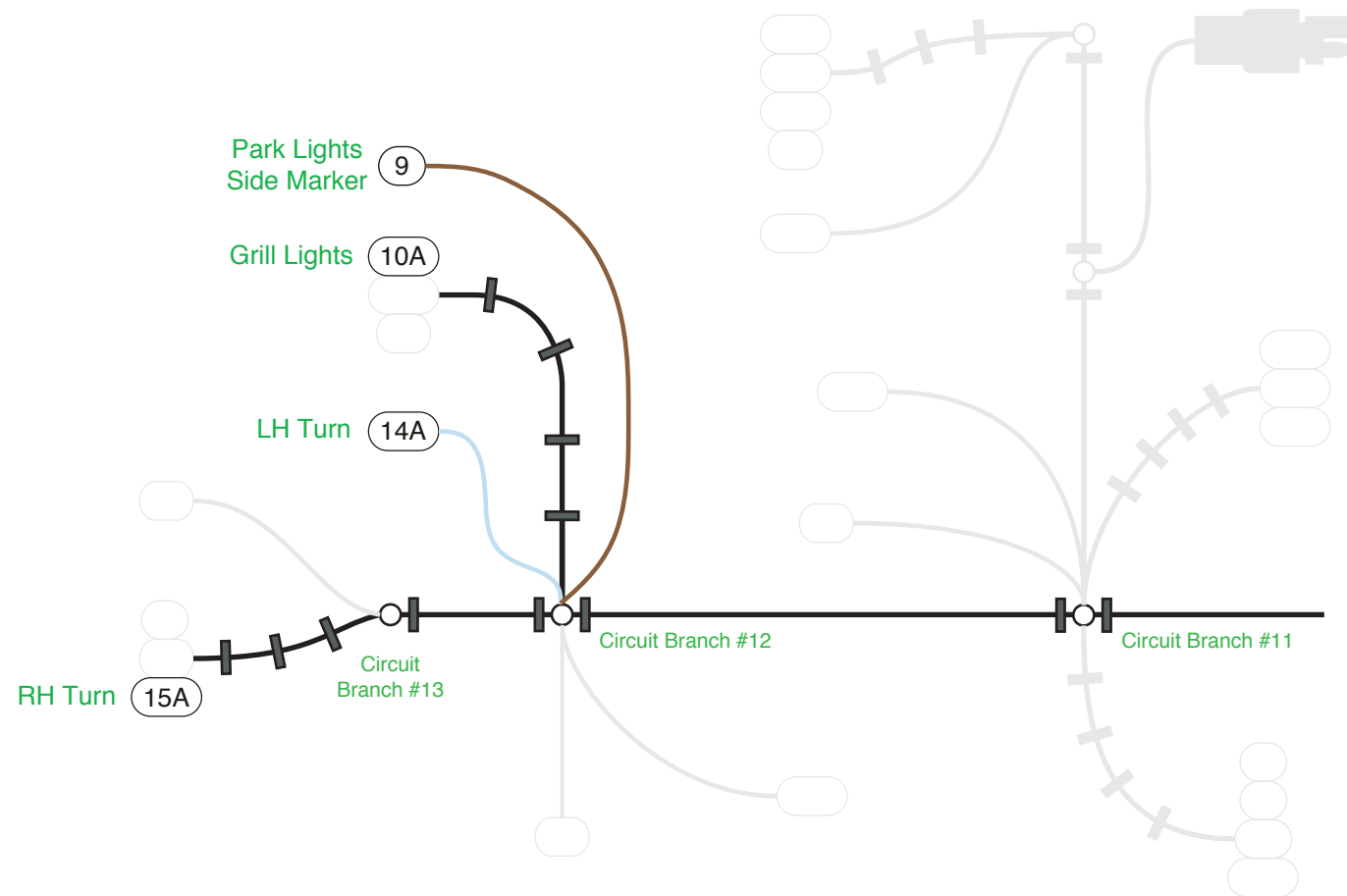

MAIN HARNESS
 1971-73 Ford Mustang
 Classic Update Series

510662
 Rev 1.0 7/21/2017 JM

92971679

Figure II (see page 19)
 Route the wiring across the Cow! Top to the center of the upper Firewall. Also route the Starter Solenoid Wiring together with the Front Lighting Wiring. This is the same routing as the original Headlamp and Dash Wiring.

Backup and Neutral Safety Switch Connections (see Figure "II" on page 19)
 If you have a vehicle with an Automatic Transmission where the Back-up Light Switch and the Neutral Safety Switch are inside the vehicle on the Shifter, you will have to route the four wires (5, 6, 24, and 39A) to the Shifter and connect.

1. Back-up Light and Neutral Safety Switch Connections
 For both a Manual transmission and an Automatic Transmission, route the light green Backup Light/Switch wire (circuit 24) and the pink 12 Volt Ignition wire (circuit 39A) to the Backup Light Switch and connect. Polarity doesn't matter.

If you have a Manual Transmission, you will need to connect the purple Neutral Safety Switch wire (circuit 5) and the purple Starter Solenoid wire (circuit 6) together.
 If you have an Automatic Transmission, route the purple Neutral Safety Switch wire (circuit 5) and the purple Starter Solenoid wire (circuit 6) to the Neutral Safety Switch and connect.

NOTE: If circuit 5 and circuit 6 are not connected, your Starter Solenoid will not engage, and your Engine will not crank.

Wire #	Wire Color	Printing	Description
5	Purple	NEUTRAL SAFETY SWITCH	Start feed from the Ignition Switch to the Neutral Safety Switch or to circuit 6.
6	Purple	STARTER SOLENOID-S	Start circuit from the Neutral Safety Switch or circuit 5 to the Starter Solenoid.
24	Light Green	BACK UP LT SW->LIGHTS	Feed from the Backup Light Switch to the Backup Lights.
39A	Pink	12V IGNITION	12V feed to the Backup Light Switch.

2. Electric Speedometer (optional)
NOTE: These three wires are only used if you are using an Aftermarket Electric Speedometer.
 Obtain the purple/white "VSS POWER" wire (circuit 402), the purple "VSS SIGNAL" wire (circuit 401) and the yellow "VSS GROUND" wire (circuit 400) and route these three wires to the Vehicle Speed Sensor and connect the purple/white wire to the VSS power lead, the purple wire to the VSS signal lead, and the yellow wire to the VSS ground lead.

Wire #	Wire Color	Printing	Description
400	Yellow	VSS GROUND	Vehicle Speed Sensor Ground.
401	Purple	VSS SIGNAL	Vehicle Speed Sensor Signal.
402	Purple/White	VSS POWER	Vehicle Speed Sensor Power.

3. Wiper Motor Connector
 Plug this 4-way connector to the Wiper Motor Pigtail.

ENGINE CONNECTIONS (see Figure "II" on page 19)

1. Electric Choke
 Obtain the tan "ELECTRIC CHOKE" wire (circuit 39C) and route this wire to the Electric Choke and connect. Cut to length, crimp on terminal "C" and insert into connector "B".

Wire #	Wire Color	Printing	Description
39C	Tan	ELECTRIC CHOKE	Feed to the Electric Choke.

2. Engine Sensors
 Route the dark blue "OIL PRESSURE SENDER" wire (circuit 31A) to the Oil Pressure Sender, and the dark green "WATER TEMP SENDER" wire (circuit 35A) to the Water Temperature Sender, cut to length, install terminals "C" or "U" (install sleeve "R" first if using "U"). If you are using terminal "C", plug it into connector "F".

Wire #	Wire Color	Printing	Description
31A	Dark Blue	OIL PRESSURE SENDER	Oil Pressure Sender.
35A	Dark Green	WATER TEMP SENDER	Water Temperature Sender.

3. Ignition Feed
 This pink "IGNITION FEED-COIL" wire (circuit 3F) is the 12V switched power source for the Distributor/Ignition Coil. This wire can be connected directly to the "Bat" terminal on a typical HEI Distributor, to a Ballast Resistor for a points type Distributor, or to be used as the ignition power source for an Aftermarket Ignition Module such as an MSD or a "Dura Spark" module. See the installation instructions for the type of Distributor/Ignition Module you are using for specific connection requirements.

If you are using a GM style HEI Distributor, terminal "D" and connector "V" have been provided for circuit 3F to make the connection.

If you are using a Ballast Resistor (Ballast Resistor not included in this kit), two "D" terminals, and two "B" connectors have been provided for circuit 3F to make the connection. Also Starter Resistor Bypass Wire "LL" is provided to connect to your Starter Solenoid Terminal I and to the Ballast Resistor.

Note: A Ballast Resistor is available from AAW under part number 500801.

Wire #	Wire Color	Printing	Description
3F	Pink	IGNITION FEED-COIL	Switched 12V Ignition feed for the ignition.

4. Tachometer
NOTE: This wire is only used if you have an Aftermarket Tachometer.
 Obtain the white "COIL -> TACH" wire (circuit 121) and route and connect as follows:

If you have an Aftermarket Ignition Module such as an MSD Module, route the white wire to the module and connect to the Tachometer connection of the module.

If you are using a GM style HEI Distributor, terminal "C" and connector "W" have been provided to make the connection.

If you have a points type Ignition System, route the white wire to the Ignition Coil and connect to the (-) terminal.

Wire #	Wire Color	Printing	Description
121	White	COIL->TACH	Tachometer feed wire.

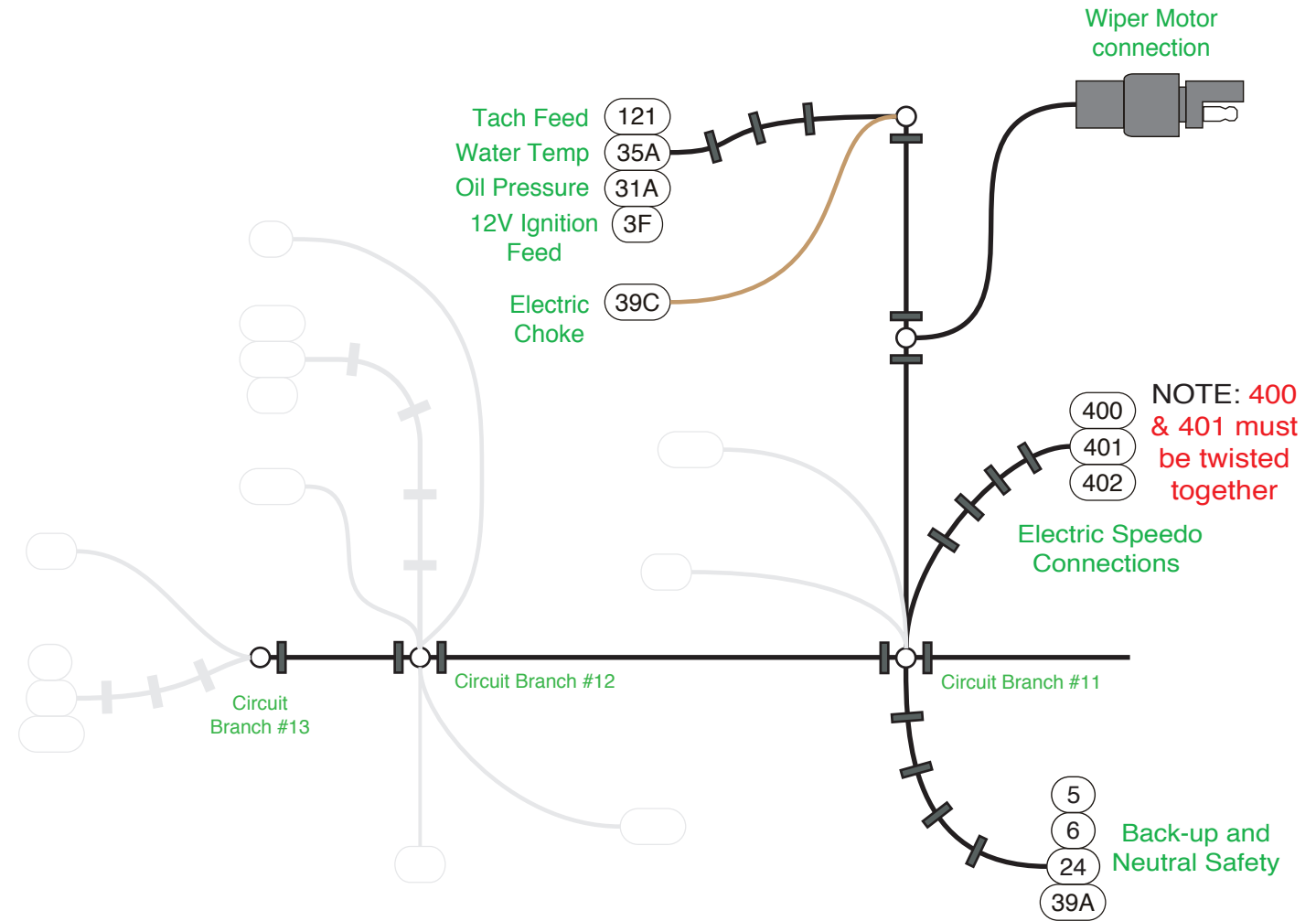

MAIN HARNESS
 1971-73 Ford Mustang
 Classic Update Series

510662
 Rev 1.0 7/21/2017 JM

92971679





www.americanautowire.com 856-933-0801

Figure II (continued, see page 19)

STARTER SOLENOID CONNECTIONS (see Figure "II" on page 19)

1. Main Fuse Panel Feed

Obtain the brown **Main Power Feed Fusible Link Jumper Harness "KK"** and attach the ring terminal to the battery stud (**BAT**) of the Starter Solenoid. Obtain the large red "12V BATTERY" wire (circuit 2A) from the Dash Harness and route it to the Starter Solenoid, cut to length, install terminal "D" and plug into connector "B". Connect "B" to the **Jumper Harness "KK"**.

Main Power Feed Fusible Link Jumper Harness "KK"

Wire #	Wire Color	Printing	Description
2J	Brown	Fusible Link	This is the circuit protection for the main power feed to the Fuse Block.

Dash Harness Wire

Wire #	Wire Color	Printing	Description
2A	Red	12V BATTERY	Main Power feed to the Fuse Block.

2. Start Circuit Solenoid Wire

Route the purple "STARTER SOLENOID - S" wire (circuit 6) to the Starter Solenoid and cut to length, install large sleeve "E" and crimp on ring terminal "S". Connect to the Starter Solenoid **S (start)** stud.

Wire #	Wire Color	Printing	Description
6	Purple	STARTER SOLENOID-S	This is the start circuit.

Start Circuit Resistor Bypass Wire

NOTE: For Ignition Systems that have a Ballast Resistor in the Ignition feed to the Ignition Coil, this wire bypasses that resistor during Crank allowing a higher voltage.

Obtain the yellow **Starter Solenoid Resistor Bypass Wiring Jumper Harness "LL"** and attach the ring terminal to the "I" (**ignition bypass**) terminal of the Starter Solenoid. Route the other end of the yellow wire to the Ballast Resistor and cut to length. Obtain the cutoff section of the large pink wire (circuit 3F from Circuit Branch #11, step 7) and double it with the yellow wire, crimp on terminal "D" and insert into connector "B". You can now connect to the Ballast Resistor. The other end of the large pink wire can be routed and connected to the (+) side of your Ignition Coil.

Starter Solenoid Resistor Bypass Wiring "LL".

Wire #	Wire Color	Printing	Description
7	Yellow	STARTER SOLENOID-R	Resistor Bypass wire.

Alternator Connections (see Figure "II" on page 19)

Alternator Output Circuit

Obtain the **Alternator Feed Wiring Jumper Harness "MM"** and connect the ring terminal of the blue fusible link wire to the Battery Terminal of the Starter Solenoid. Route the large red wire of the **Jumper Harness "MM"** to the Battery stud on the Alternator, cut to length, slide on the large sleeve "E" and crimp on the large ring terminal "T".

Wire #	Wire Color	Printing	Description
2	Red	no printing	Alternator output wire.
2H	Light Blue	Fusible Link	This Fusible Link is the circuit protection for the Alternator output.

3. Alternator Exciter Wire

NOTE: This brown wire is only used if you have an Aftermarket Alternator with an internal Voltage Regulator. This is the exciter wire for your Alternator/Voltage Regulator.

If you are using a 1-wire Alternator (recommended) this brown wire will not be used and should be capped off as it is "hot" when the Ignition Switch is in the "ON or ACC" position.

If not using a 1-wire Alternator, this brown "ALTERNATOR IGN" wire (circuit 4F) in your Dash Harness must be connected to the "Switched or 12V Ignition" terminal on your Voltage Regulator or Alternator according to the manufacturers specifications. An inline diode or resistor may be necessary to eliminate "run on" after being switched off. AAW recommends a Ford Gen 3 Internally Regulated or a 1-wire Alternator.

If you are using a GM "SI" Alternator obtain the **GM "SI" Alternator Exciter Wiring Jumper Harness "NN"**. Attach the ring terminal end of the **Jumper Harness "NN"** to the Battery stud of the Alternator. Route the brown wire (circuit 4F) from the Dash Harness to the 2-way connector of the **Jumper Harness "NN"**. Crimp on terminal "C" to the brown wire and plug into the open cavity of the 2-way connector of the **Jumper Harness "NN"**. Now plug the 2-way connector of the **"NN" Jumper Harness** into the "SI" Alternator.

Wire #	Wire Color	Printing	Description
2L	Red	no printing	Alternator Battery stud wire in the GM "SI" Alternator Exciter Wiring Jumper Harness.
4F	Brown	ALTERNATOR IGN	Alternator exciter wire.

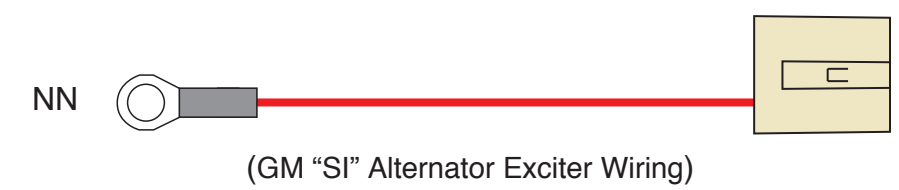
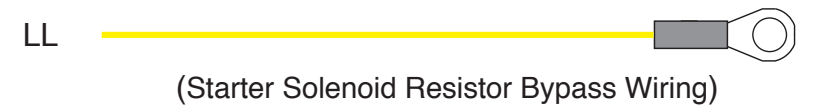
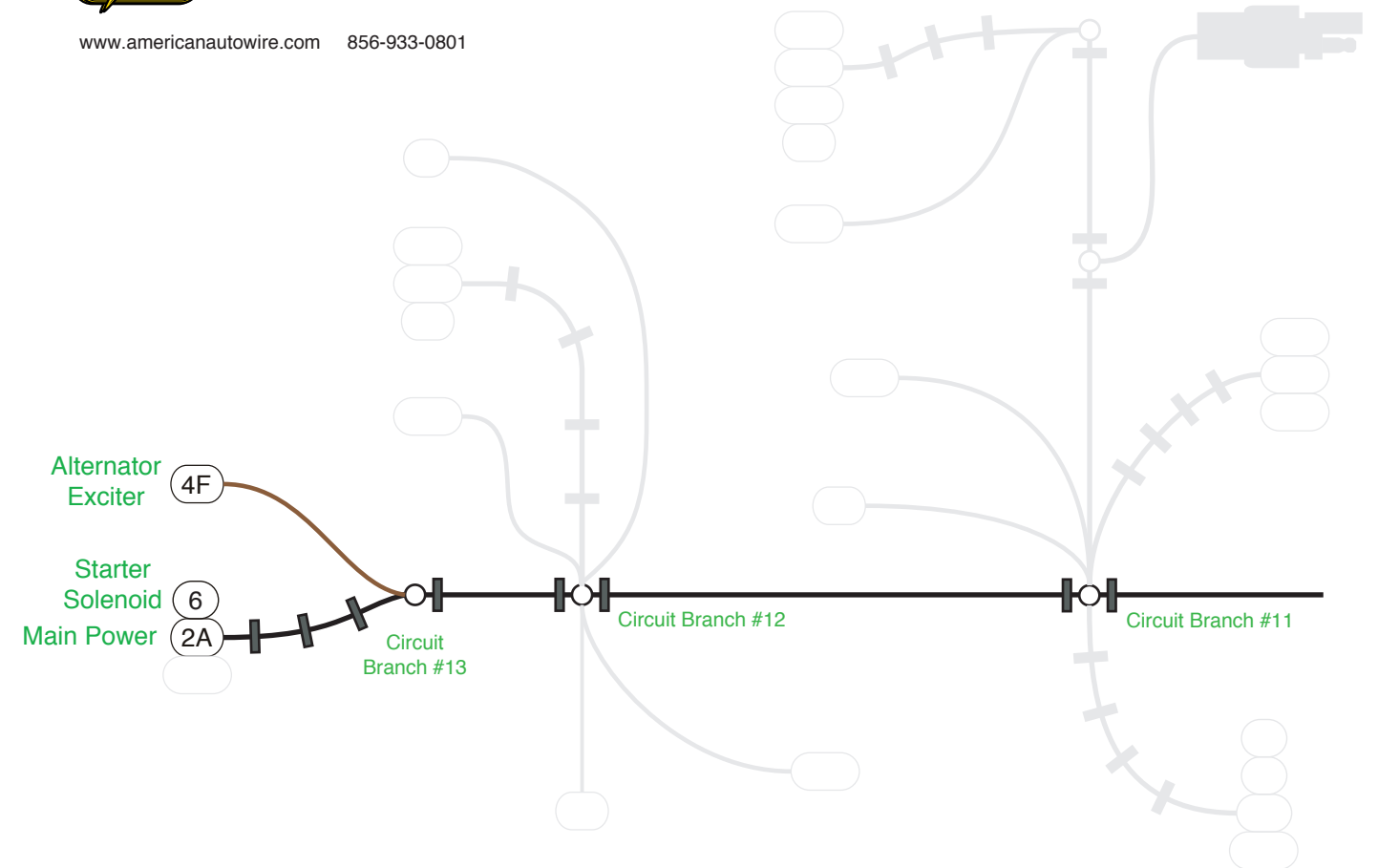

MAIN HARNESS
 1971-73 Ford Mustang
 Classic Update Series

510662
 Rev 1.0 7/21/2017 JM

92971679



NOTE: The terminals and connectors listed on this page and denoted with **UPPER CASE LETTERS**, to help you complete the various connections to your lights, horns, brake warning switch, washer pump and electric fan, can be found in your loose piece, clamp, grommet and parts kit, P/N **510666**.

The identifications, colors, and functions, for all of the wires listed on this page, can be found in your Instructions for circuit branches #11 and #12 (on **pages 14-15**).

Figure "I"
Front lights, horns, brake warning switch, washer pump and and electric fan,.
These wires are all found on **pages 14-15**,
Branches #11-#12.

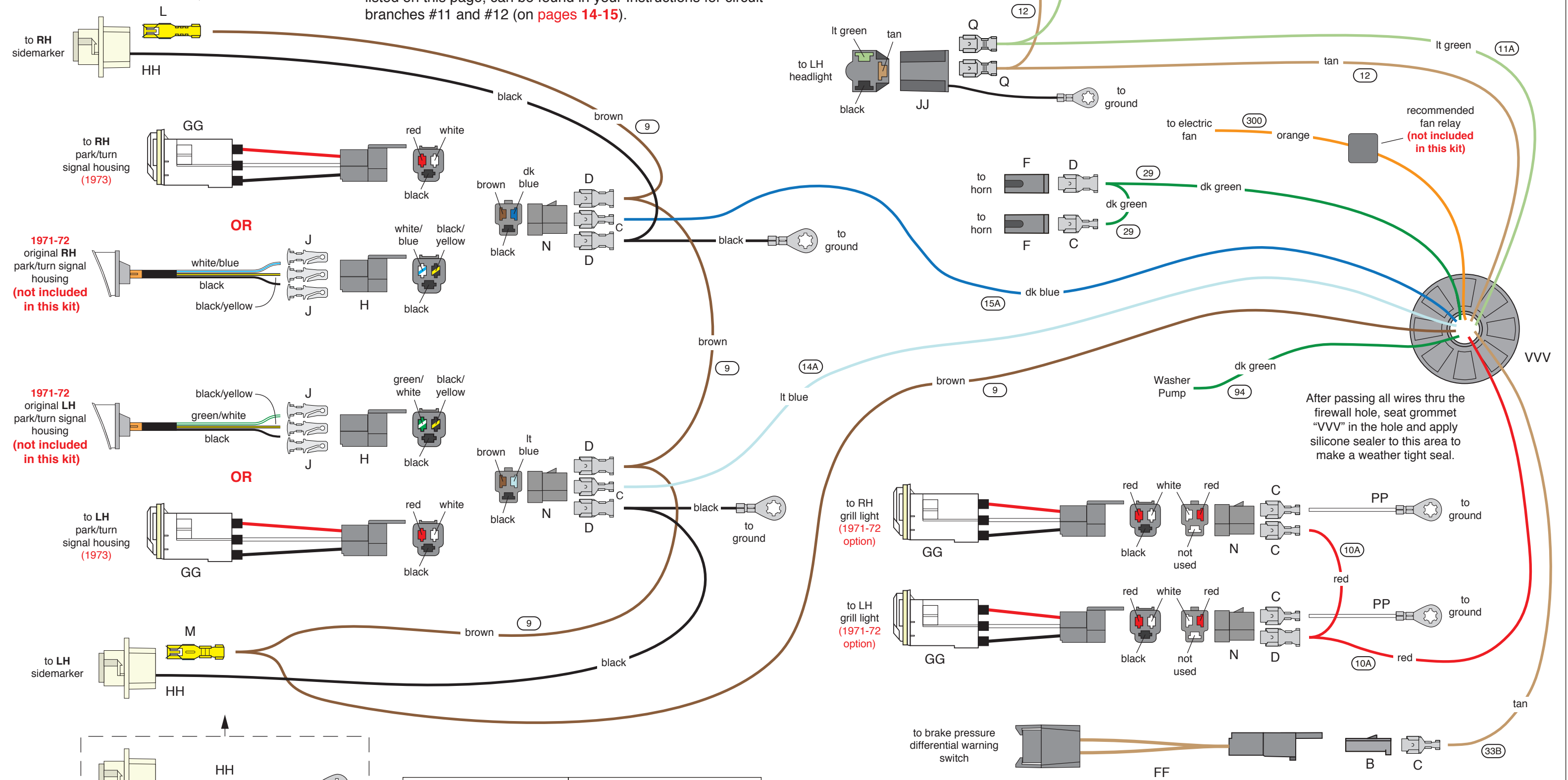

After passing all wires thru the firewall hole, seat grommet "VVV" in the hole and apply silicone sealer to this area to make a weather tight seal.

MAIN HARNESS 1971-73 Ford Mustang Classic Update Series	510662 Rev 1.0 7/21/2017 JM
	92971679

92971679

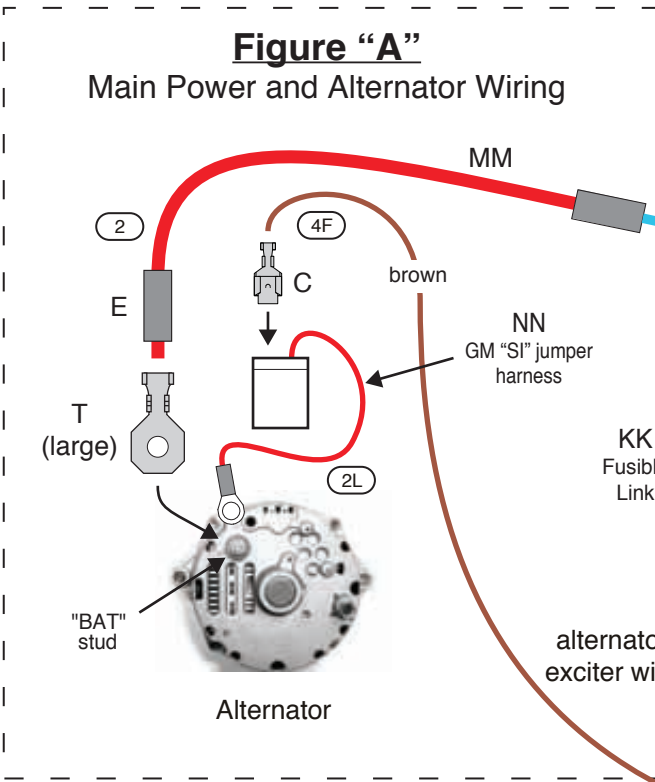
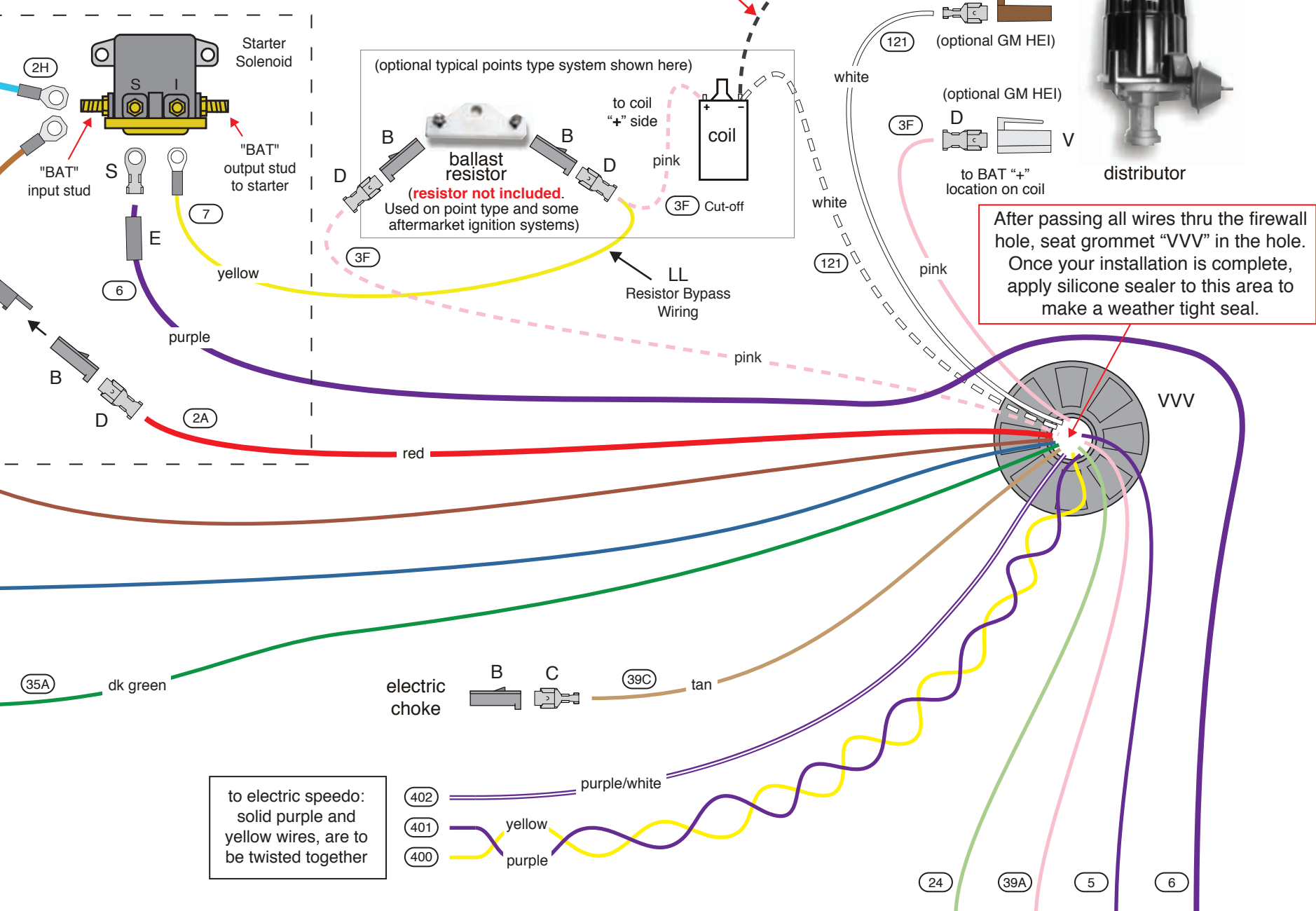

Figure "II"
Ignition, engine sensors, electric choke, tachometer, electric speedometer, alternator, back-up switch and NSS



NOTE: The terminals and connectors listed on this page and denoted with **UPPER CASE LETTERS**, to help you complete the various connections to your ignition feed, engine sensors, electric choke, tachometer, electric speedometer, alternator output, back-up switch and NSS, can be found in your loose piece, clamp, grommet and parts kit, P/N **510666**.

The identifications, colors, and functions, for all of the wires listed in Figure "A" and Figure "B", on this page, can be found on **pages 16 and 17**, branches #11 and #13, of this instruction set.

AAW kits are all engineered to be used in conjunction with a high output, later model internally regulated, or one wire alternators. We do not suggest or support the use of a stock, low amperage generator or alternator, as they do not supply sufficient current to recharge the battery in a highly modified car such as this kit was designed for. AAW suggests a Ford Gen III (3G), a GM "SI", or a 1 wire type alternator as good choices to use. An adapter to complete the connection to the Ford Gen III (3G) style alternator (AAW p/n 500802) may be purchased separately. Contact AAW for your needs.

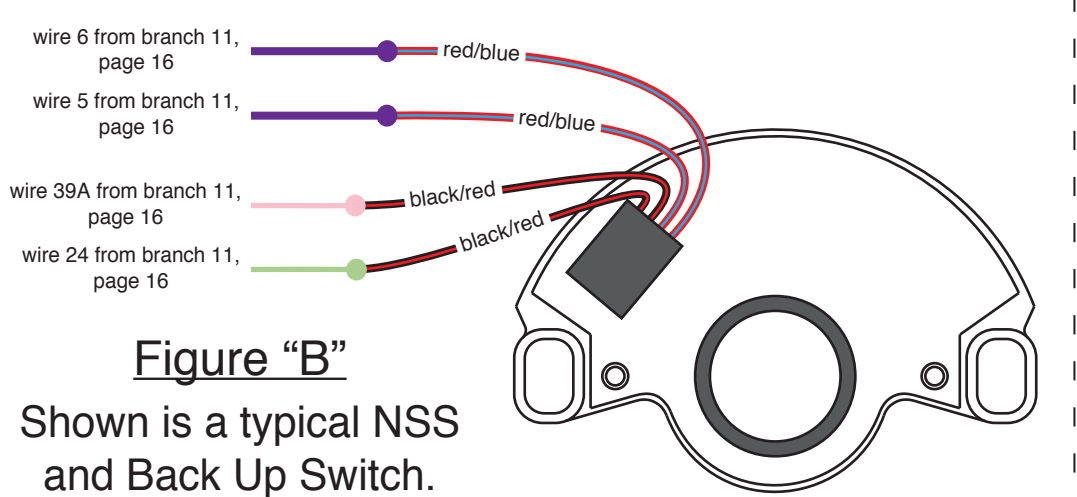
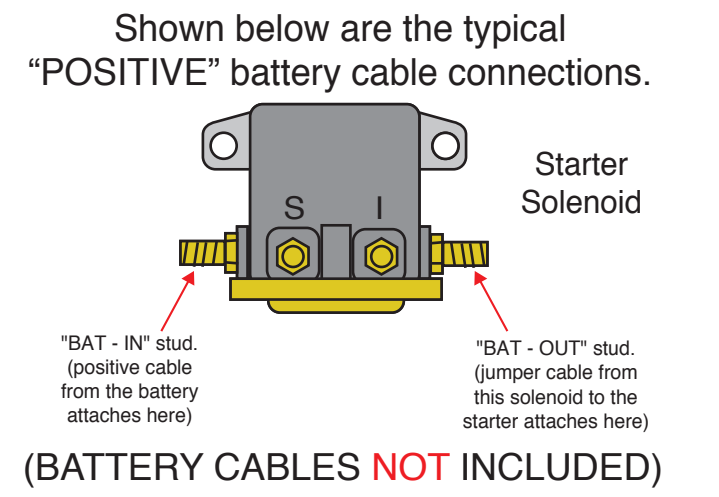

MAIN HARNESS
1971-73 Ford Mustang
Classic Update Series

510662
Rev 1.0 7/21/2017 JM

92971679

AMERICAN AUTOWIRE DASH HARNESS CONNECTION

ORIGINAL TURN SIGNAL SWITCH WIRING

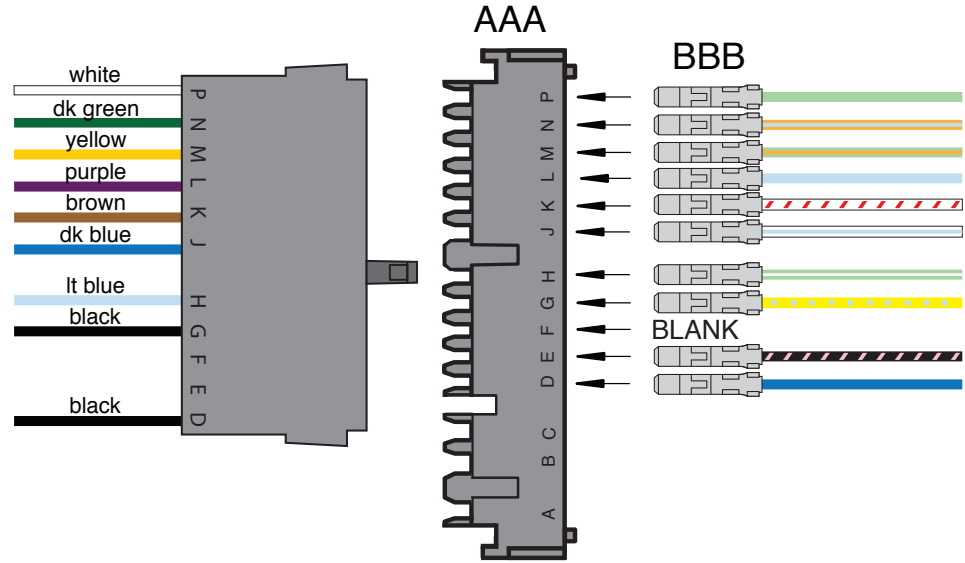

DIAGRAM 'A' - AAW Turn Signal Switch Wires to Stock 1971-73 Steering Columns.

“Table A”

AAW Turn Signal Switch wires to stock 1971-73 Ford Mustang Turn Signal Switch

AAW Wire #	AAW Wire Color	AAW Wire Printing	Connector Cavity AAW	Ford Turn Signal Switch Wire Color
17	White	Brake SW	P	Light Green
19	Dark Green	Right Rear Turn	N	Orange/Lt Blue
18	Yellow	Left Rear Turn	M	Lt Green/Orange
16	Purple	Turn Switch Feed	L	Lt Blue
27	Brown	Turn SW – Hazard	K	White/Red
15, 15A	Dark Blue	Right Front Turn	J	White/Lt Blue
14, 14A	Light Blue	Left Front Turn	H	Light Green/White (thin)
28	Black	Horn Relay Ground	G	Yellow/Lt Blue
None	None	None	F	None
None	None	None	E	Black/Pink
28A	Black	Horn Relay Ground (from Horn Switch)	D	Dark Blue

Note: Remove the original Turn Signal Switch Connector and replace it with the AAW 14-way connector “AAA”. Crimp on terminal “BBB” to each of the original Turn Signal Switch wires and plug them into connector “AAA” (see Parts Kit 92971684). Use “Table A” above to align the wires. Also, for all of the vehicles, the original design had the Steering Wheel Horn Button switching power for the Horns. With the AAW design, the Horn Button switches the ground wire of the Horn Relay coil.

Note: The Black/Pink Ford wire is for the Key-in Ignition Warning Buzzer and is not used. It can be installed in cavity E or taped back.

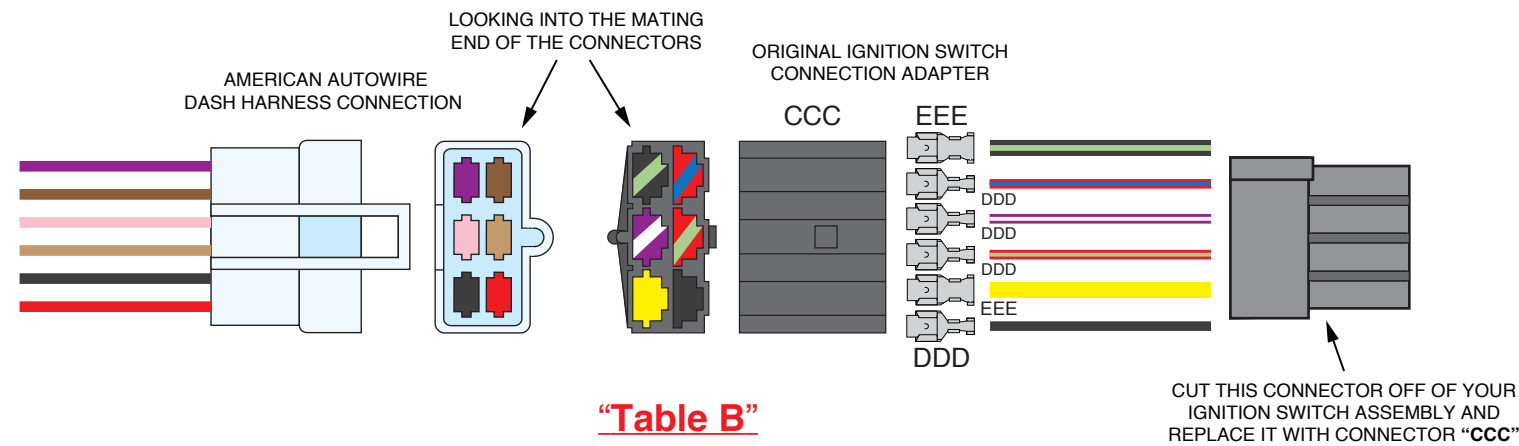

“Table B”

1971-73 Ford Mustang Ignition Switch Wires

AAW Wire #	AAW Wire Color	AAW Wire Printing	Wire Description	Ford Wire Color
5	Purple	NEUTRAL SAFETY SWITCH	Start	Red/Blue (thin)
4A, E	Brown (double)	IGNITION SW ACCY	12V Accessory Feed	Black/Lt Green (thick)
3E	Pink	12V IGNITION	12V Ignition Feed	Red/Lt Green (thin)
33C, D	Tan	BRAKE LIGHT/SWITCH	Brake Light Prove-out	Purple/White (thin)
150M, N	Black (double)	GROUND	Ground	Black (thin)
2B	Red	12V BATTERY	12V Battery Feed	Yellow (thick)

Note: Be sure to align the Ford wire with the corresponding AAW wire in the 6-way connector “CCC”. Crimp on terminal “DDD” for the thinner wires and terminal “EEE” for the thicker wires (see Parts Kit 92971684). The additional thin red/white wire in the original stock Ignition Switch Connector pigtail was used as a Water Temperature light bulb prove-out circuit and will not be used and should be taped back.



www.americanautowire.com 856-933-0801

MAIN HARNESS

1971-73 Ford Mustang Classic Update Series

510662

Rev 1.0 7/21/2017 JM

92971679