



**WARNING:**

Validate the kit contents with the component list included on this page, before proceeding. This kit is intended to be used in a modified vehicle. Please read this page thoroughly and be sure that you understand everything explained on it prior to opening any of the enclosed packages, or before attempting to install any of the components. Once this kit has been opened or a component installed, the kit is not returnable.

1. This new upgraded AAW wiring system should typically be used in a **MODIFIED** application only.
2. This kit includes the wiring to support the use of a factory heater only system and/or aftermarket heater and A/C systems. This kit does not include the wiring for the factory original **A/C** system. For **1974-76**, aftermarket A/C systems **only** are supported. For **1977-78 factory** A/C Harnesses, call American Autowire for your application.
3. This kit supports the use of a high current self-exciting 1-wire, "SI" series, or other style internally regulated alternator. An adapter may be necessary in some applications. The use of stock, low amperage alternators is seriously discouraged as they cannot handle the higher current requirements of most updated ignition systems, electric fans, aftermarket A/C systems, stereo systems, air ride suspensions, and other power hungry accessories that will ultimately create performance issues within the system.
4. AAW **DOES NOT** support the use of an ammeter. All AAW kits are engineered to supply the optimum charge to the battery. To achieve this performance, we route our 8ga. charge wire directly from the alternator output charge terminal to the starter battery terminal. Due to the path of the charge being altered from the stock configuration, the gauge can no longer see a charge vs. a discharge, so it may not work properly. Most stock alternator current outputs were rated at a maximum of about 37-60 amps. Modified cars being built today typically utilize a 100 amp or higher output alternator. With these higher current units, ammeters, generally speaking, become a safety hazard. Ammeters are usually wired in parallel to the charging circuit, are typically unfused, and can short very easily causing a fire. This wiring system has been designed to work with a voltmeter.
5. This kit **IS NOT** set up with a resistance wire for a standard, points type ignition system. It is wired with a full 12-volt primary ignition feed that is hot in the crank and run positions. Our system will support HEI, MSD, other electronic ignition systems, as well as most all computerized Fuel Injection systems. If you wish to run a points type system, there are illustrations on the engine connection pages to do so. Primary ignition voltage in the cranking position is handled via a full 12 volt bypass wire that is routed from the starter "R" terminals to the positive side on the coil. Extra parts (ballast resistor) that are not included in this kit will be required to complete that type of operation.

**510683 - Classic Update Series Kit  
1974-78 Firebird**

This kit contains the following components:

Bag	Part Number	Description	Quantity
	500042	Floor Dimmer Switch	1
	500332	Headlight Switch	1
	500707	Fuse, Relay, and Flasher kit	1
	500708	Courtesy Lamp Kit	1
	500919	Practice Terminal Crimping Set	1
G	510684	Dash Harness kit	1
H	510685	Instrument Cluster wiring kit	1
J	510686	Engine Wiring Kit	1
L	510687	Front Light Wiring kit	1
M	510688	Rear Body Wiring kit	1

Validate the kit contents with this component list. If there are any discrepancies with incorrect or missing parts, stop your installation and notify the supplier you purchased the kit from before proceeding.

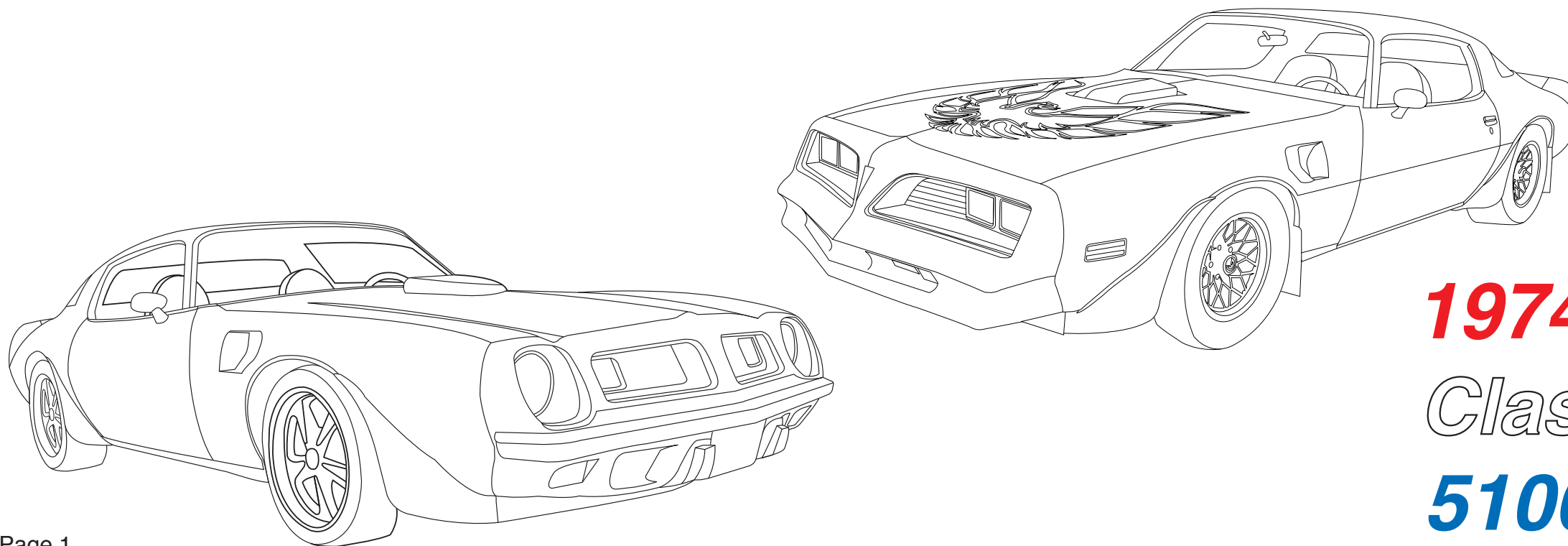

www.americanautowire.com 856-933-0801

**1974-78 Firebird**  
*Classic Update Series*  
**510683**

© COPYRIGHT 2004 American Autowire / Factory-Fit  
Used with express permission of  
American Autowire / Factory-Fit

92971778 Rev 1.0 8/31/2017

# START HERE !

## PLEASE READ THIS BEFORE STARTING INSTALLATION !

This wiring kit is designed for ease of installation. Please read the guidelines below, BEFORE STARTING your installation, to guarantee a successful job. Use an appropriate crimping tool, which folds the wings of the open barrel terminals down into the wire, as shown on this page. If you use our crimping tools and correctly crimp the included terminals, soldering is not necessary. If you are unsure about a particular crimp, soldering is recommended. Our factory crimped terminations are installed by GM approved five ton presses, and soldering these terminations is not necessary



AAW offers a great terminal crimping video entitled "Proper Crimping Video". It can be viewed by visiting YouTube.

Type the following address into your web browser, to go directly to the video:

[www.youtube.com/watch?v=JAgEDoVI-co](http://www.youtube.com/watch?v=JAgEDoVI-co)

Youtube Channel:

[www.youtube.com/user/WiringHarness](http://www.youtube.com/user/WiringHarness)

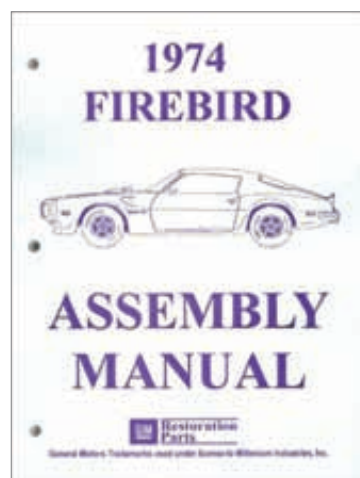

### Factory Assembly Manuals

1974 p/n 43539

1975 p/n 43540

1976 p/n 43250

The terminals that we supply in our kits, utilize what is known as an F crimp. The F crimp, in a cross section, will look like the illustration below, when done correctly.

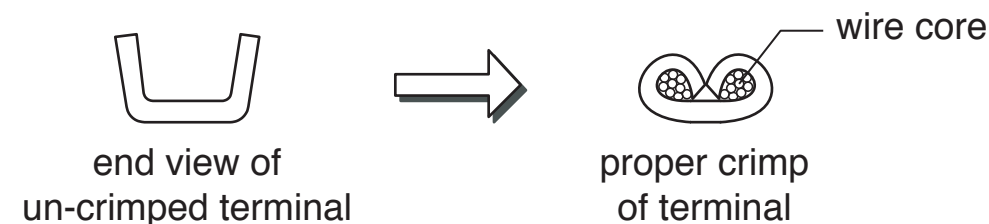

We carry the following crimping hand tools, to help with your terminal crimping. These hand tools are available, for purchase or rental.

p/n 510585  
OEM small terminal crimping tool (18-14 gauge)

p/n 510586  
OEM large terminal crimping tool (12-8 gauge)

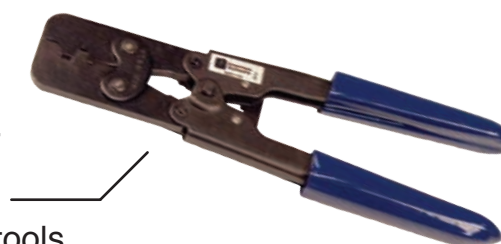

p/n 510587  
Includes Both terminal crimping tools

## We carry many accessories for your 1974-78 Firebird:



p/n 510703  
Power Window and Lock Kit  
(1974-76)



p/n 510704  
Power Window and Lock Kit  
(1977-78)



"SI" series alternator to "CS" series alternator conversion kit p/n 37796



p/n 510701  
Heated Rear Glass Kit

### STEP 1: DISCONNECT YOUR BATTERY:

Disconnect the battery, before installing the wiring kit, to prevent any accidental shorting caused by loose bare wire ends.



If you have any questions concerning this or any of our products, please feel free to call us at 1-856-933-0801.

**1974-78 Firebird**  
*Classic Update Series*  
**510683** 92971778 Rev 1.0 8/31/2017

## STEP 2: START INSTALLING KIT:

This kit is broken down into individual sections, that are identified by a letter printed on the enclosed sheets, visible through each bag. The order of installation and the pages with their installation instructions, are shown below:

### Table of Contents:

#### Bags: Pages: Sections:

**G 4 - 9 Dash Harness - This is the main harness in the kit and contains:**

- Starter solenoid connections.
- Wiper motor connections
- Brake light switch connection.
- Neutral safety switch connection.

**H 10 - 13 Gauge Cluster Harness - This Harness contains:**

- Gauge connections for aftermarket and factory gauges.

**M 14 - 15 Rear Body Harness - This Harness contains:**

- Tail light, turn signal, reverse light, and running light connections.
- Fuel pump connections.

**L 16 - 18 Front Light Harness - This Harness contains:**

- Headlight, turn signal, running light connections.
- Windshield washer connection.
- Electric fan relay trigger.
- A/C compressor connections.

**J 19 - 21 Engine Harness - This Harness contains:**

- Temperature, oil pressure, tachometer wiring.
- Ignition system / ECU power.
- Alternator connections.
- Brake fluid level wiring.



**1974-78 Firebird**

*Classic Update Series*

**510683**

## PLEASE READ THIS HELPFUL INSTALLATION TIP, BEFORE GOING ANY FURTHER!

Prior to installing the Dash/Main harness in your dashboard, plug all of the fuses, Hazard Flasher and Turn Flasher into the Fuse Block (see detailed picture below) and the Horn Relay into this harness (see detailed picture below).

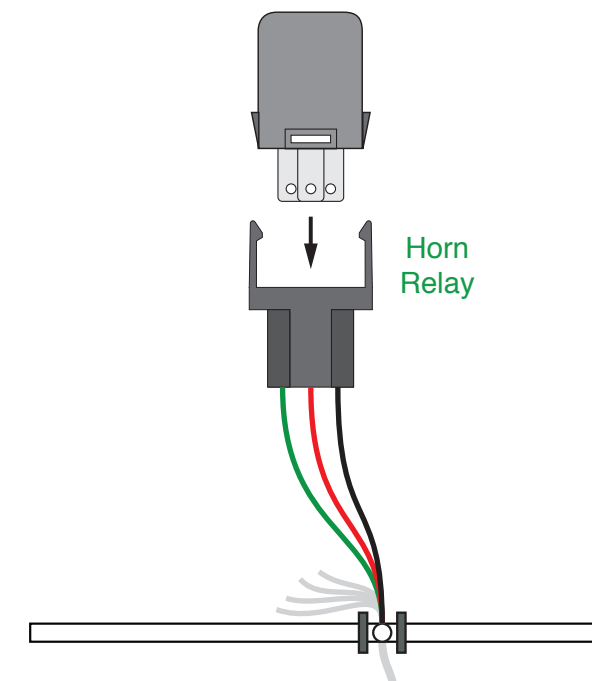
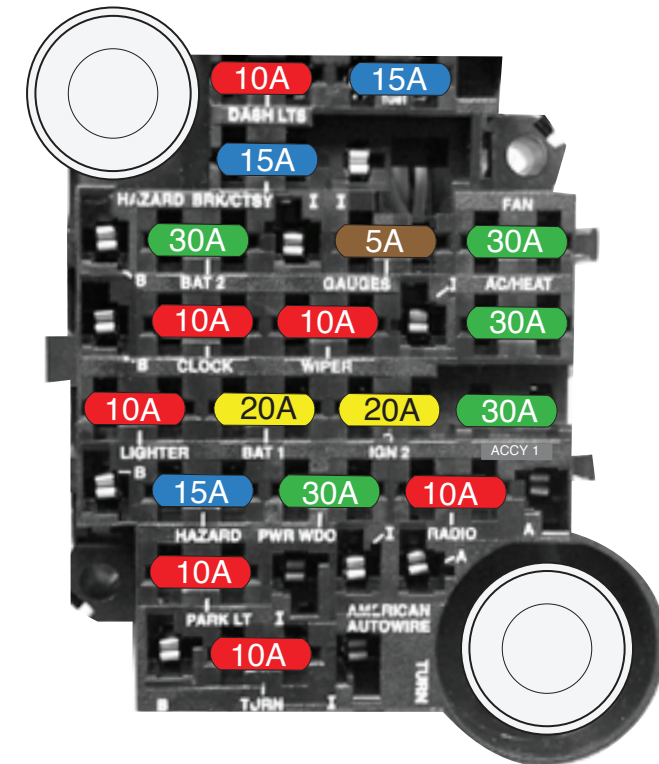



## Dash/Main harness installation instructions:

Shown below, are the supplied misc. terminals, plastic connector bodies, hardware, jumpers and extensions, included in the Dash/Main Harness and Loose Piece bags, that will be used to complete your Dash/Main harness connections. They are itemized and referred to on this page, just as they are on the following pages of this Dash/Main instruction set.

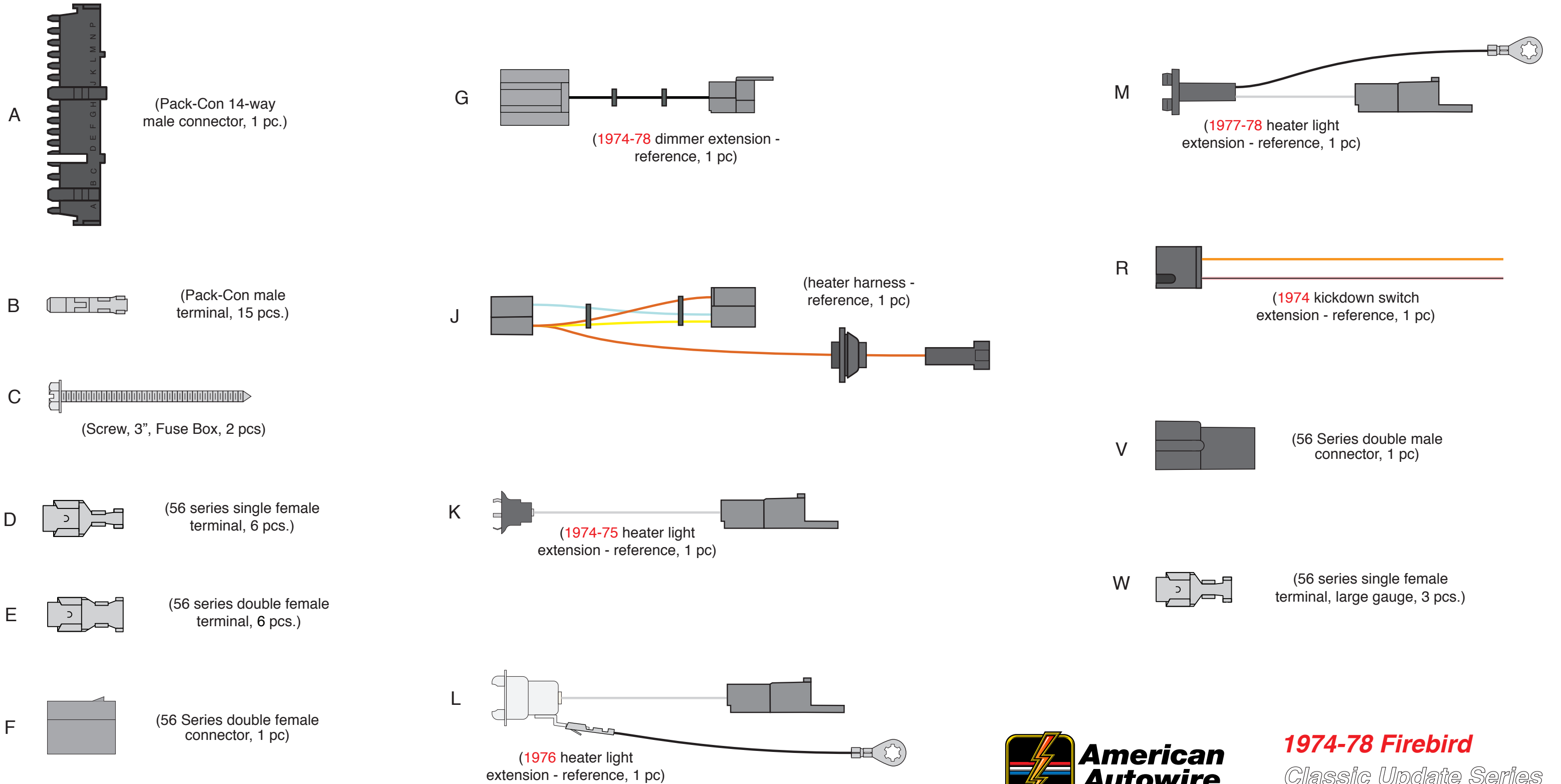

# Dash/Main harness installation instructions:



www.americanautowire.com 856-933-0801

**1974-78 Firebird**  
Classic Update Series  
**510683** 92971778 Rev 1.0 8/31/2017

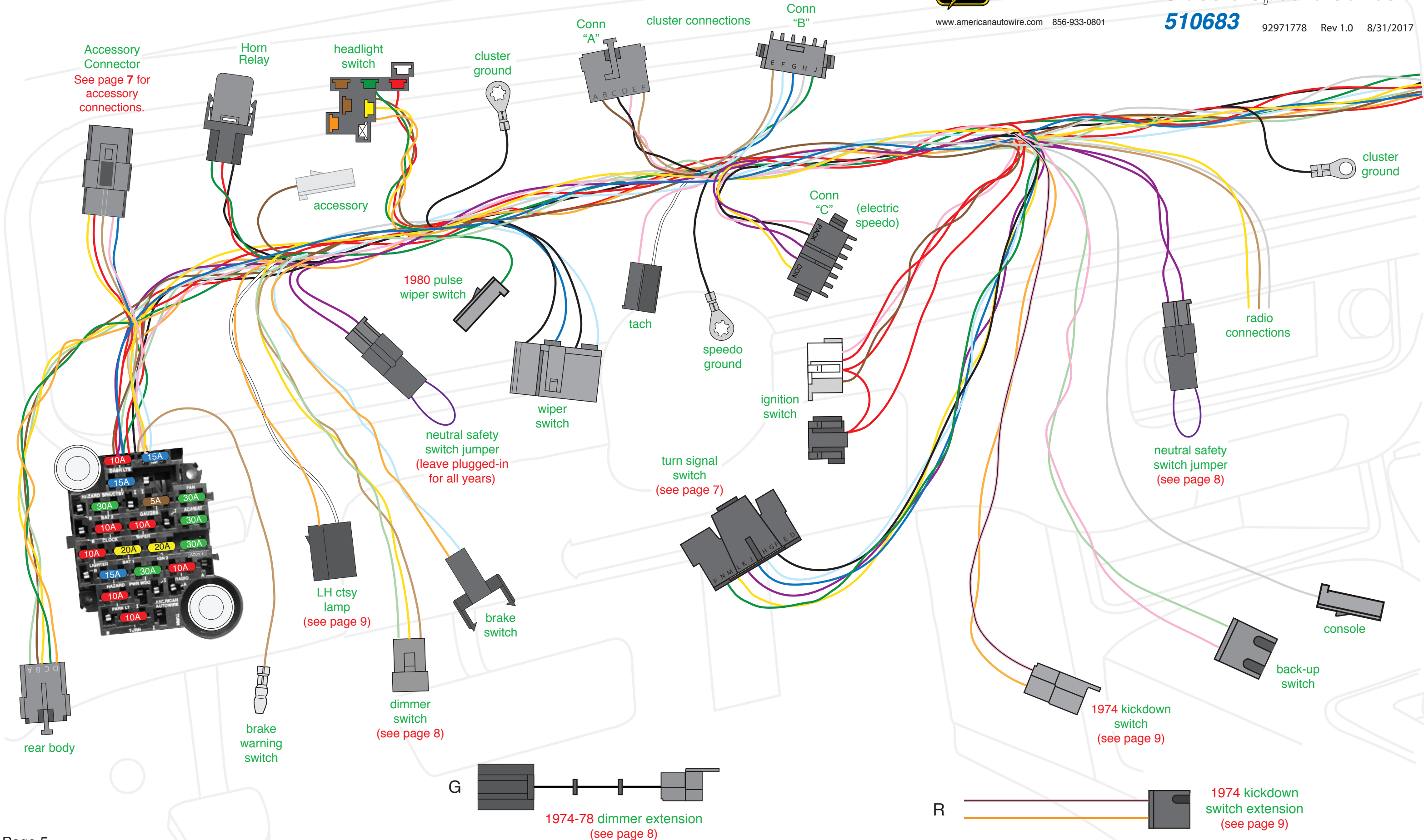

# Dash/Main harness installation instructions:

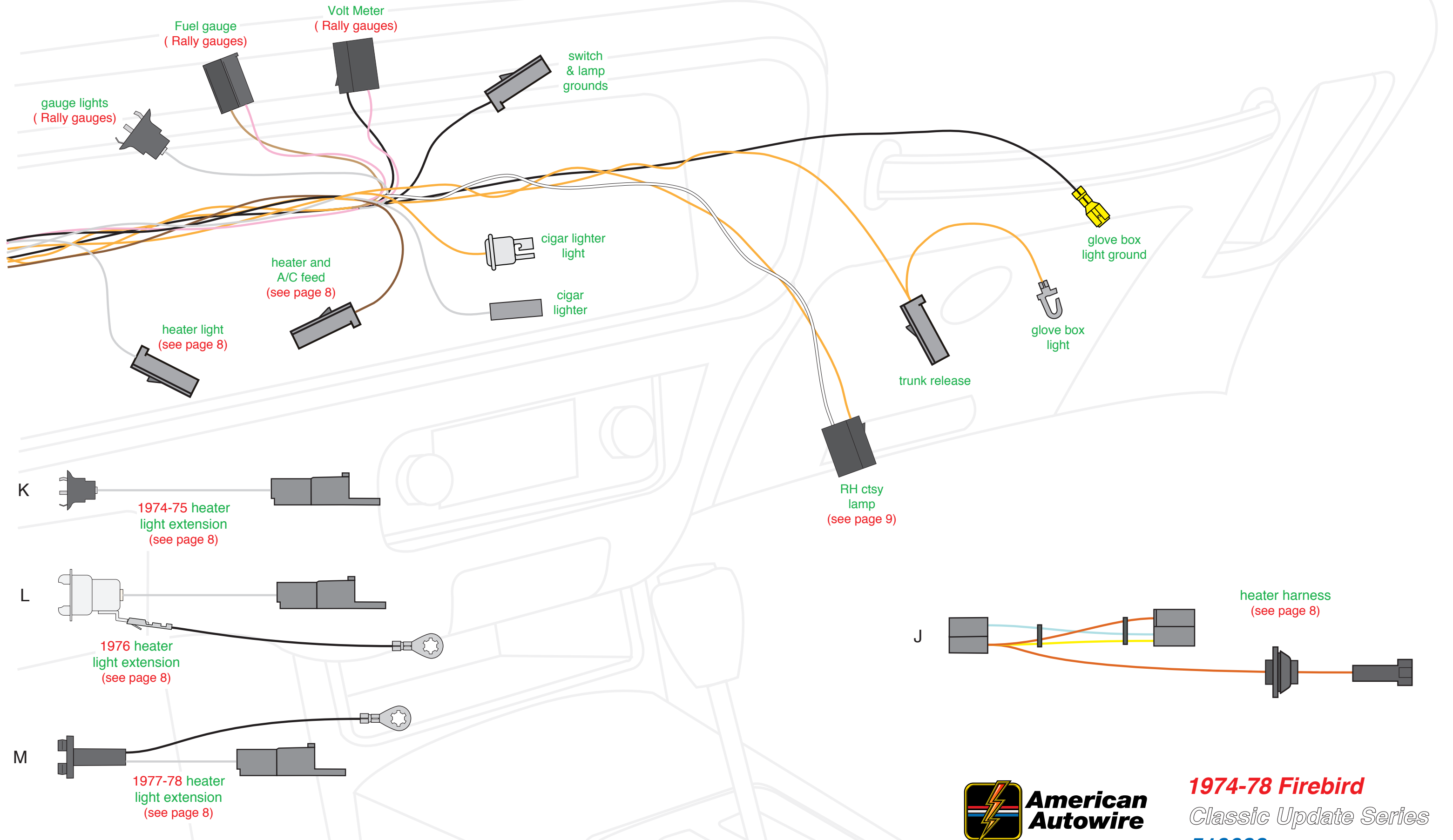

# Dash/Main harness installation instructions:

## “Table B”

AAW Turn Signal Switch wires to stock **1974-78**  
Pontiac Firebird Turn Signal Switch

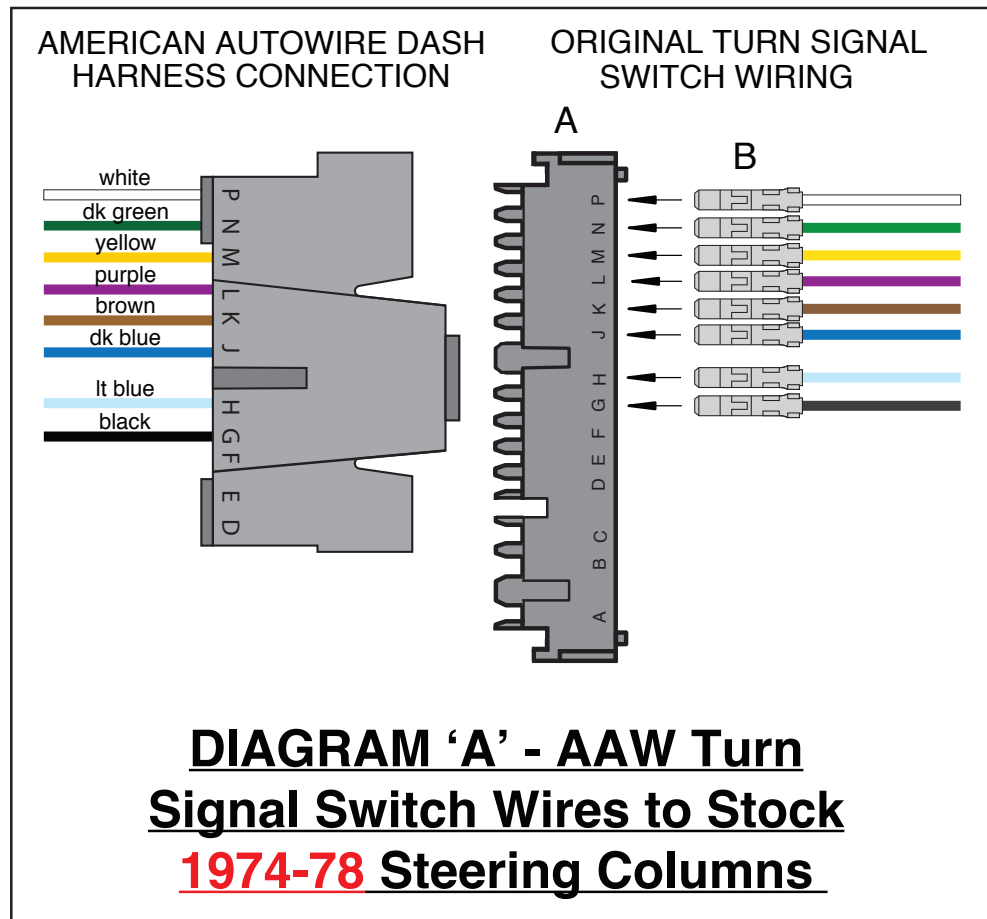

AAW Wire Color	AAW Wire Printing	Connector Cavity AAW
White	Brake SW	P
Dark Green	Right Rear Turn	N
Yellow	Left Rear Turn	M
Purple	Turn Switch Feed	L
Brown	Turn SW – Hazard	K
Dark Blue	Right Front Turn	J
Light Blue	Left Front Turn	H
Black	Horn Relay Ground	G
None	None	F
None	None	E
None	None	D

**Note:** Remove the original Turn Signal Switch Connector and replace it with the AAW 14-way connector “A”. Crimp on terminal “B” to each of the original wires and plug them into connector “A” (see Parts Kit **92971783**).

Use “Table B” above to align the wires. Also, for all of the vehicles, the Steering Column Horn Button switches ground for the Horn Relay, which then switches power to the Horns, similar to the AAW design.

### Accessory Connector

Use the provided 6-way empty connector, which is attached to the 6-way Accessory connector on the Dash Harness, and terminals “D” and “E” to add power wires (**not provided**) for the following optional systems:

Wire Color	Fuse Block Marking	Fuse rating	Description
Tan	ACCY1	30A	Fused 12 volt ACCESSORY feed which may be used to feed power to another accessory circuit.
Dark Blue	FUEL	15A	Fused 12 volt IGNITION feed for fuel pump (may also be used to feed power to another ignition circuit).
Orange	BAT1	20A	Fused 12 volt BATTERY feed for power seats (may also be used to feed power to another battery circuit).
Pink	IGN1	20A	Fused 12 volt IGNITION feed which may be used to feed power to another ignition circuit.
Red	BAT	30A	Fused 12 volt BATTERY feed (may also be used to feed power to a battery circuit).
Yellow	PWO WDO	30A	Fused 12 volt ACCESSORY feed for power windows (may also be used to feed power to another accessory circuit).



www.americanautowire.com 856-933-0801

**1974-78 Firebird**  
Classic Update Series  
**510683**

92971778 Rev 1.0 8/31/2017



# Dash/Main harness installation instructions:

## Dimmer switch wiring (all years):

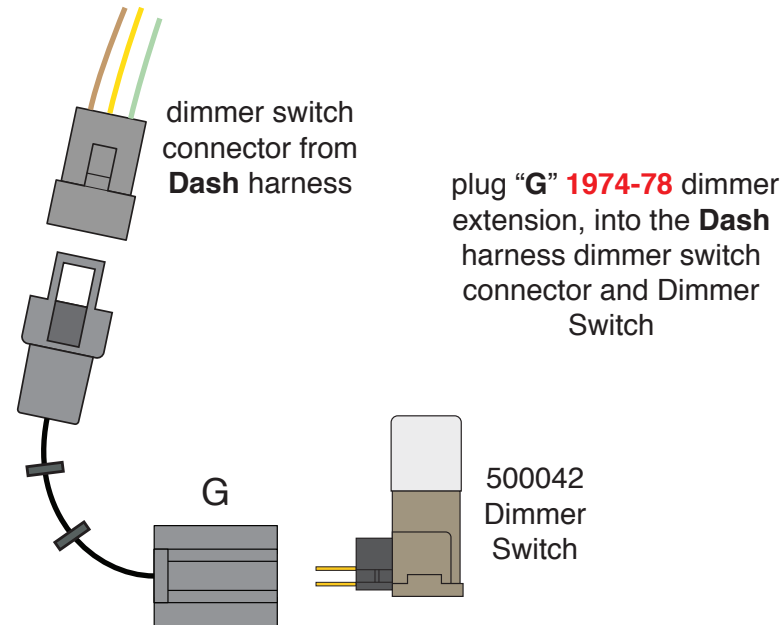

## Heater wiring (all years):

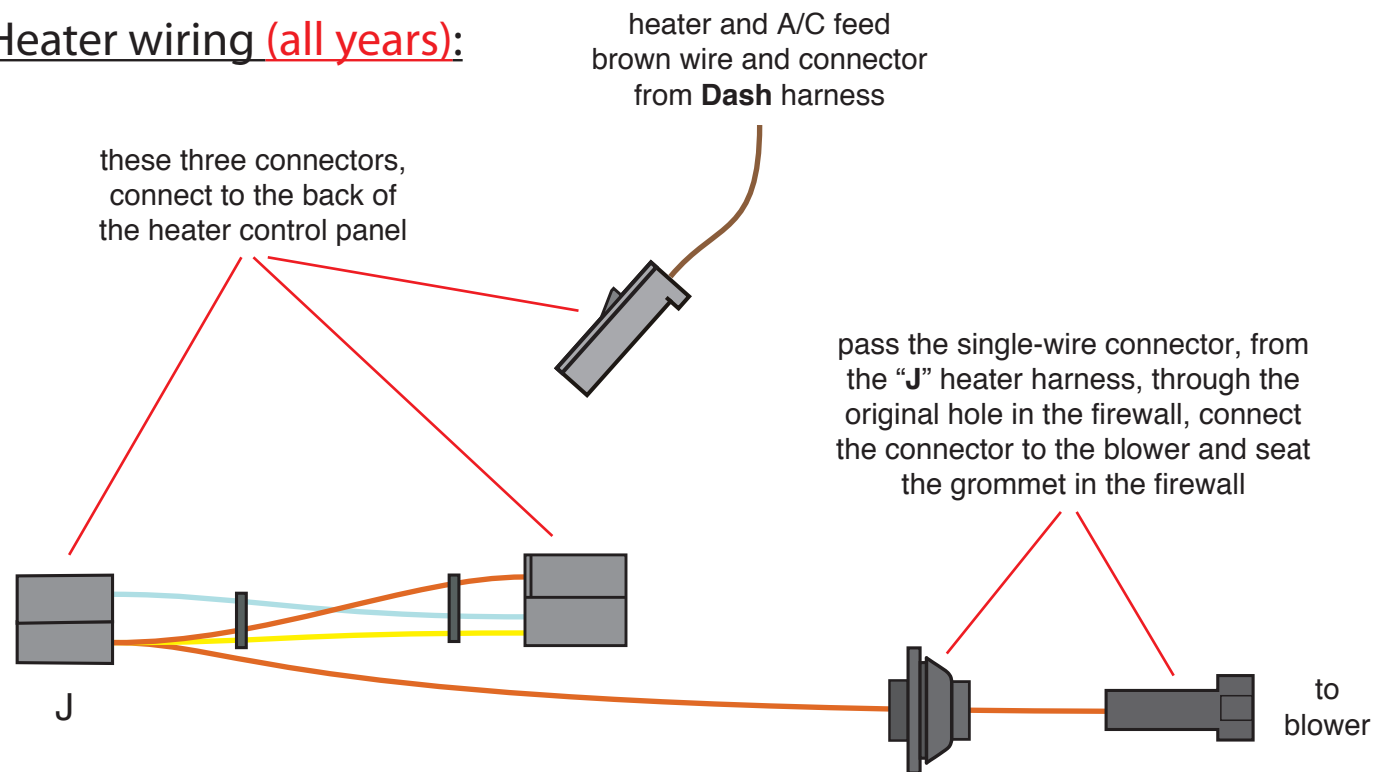

## Neutral Safety switch wiring (all years):

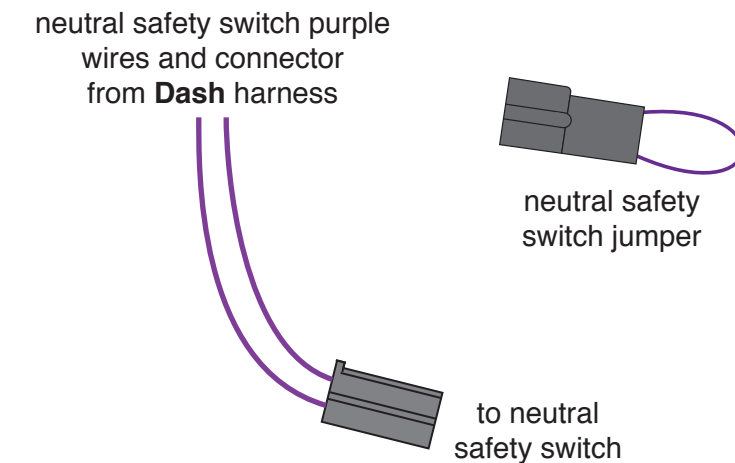

If you have a neutral safety switch, remove the "neutral safety switch jumper" from the Dash harness (at the same branch as the Ignition switch and turn signal switch) and plug the neutral safety switch connector from the Dash harness, into the neutral safety switch

## Heater light wiring:

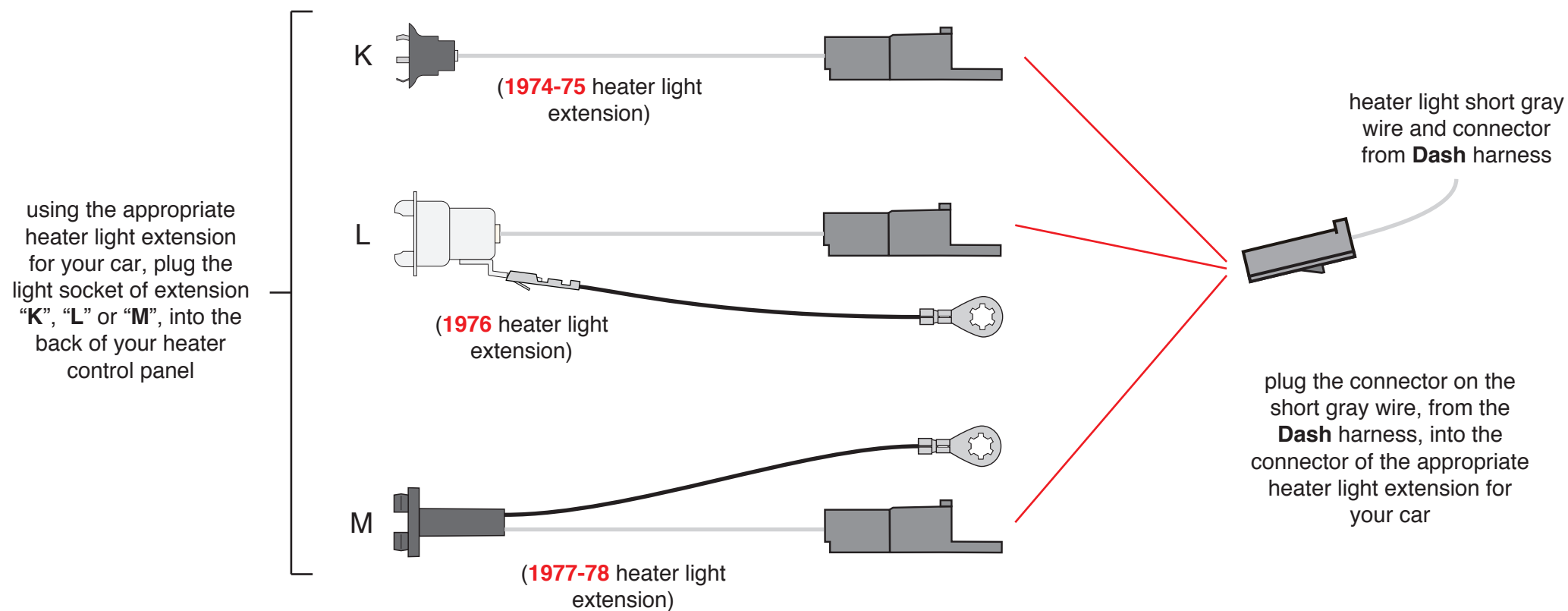

www.americanautowire.com 856-933-0801

**1974-78 Firebird**  
 Classic Update Series  
**510683** 92971778 Rev 1.0 8/31/2017



## Dash/Main harness installation instructions:

### 1974 Kickdown switch wiring:

Apply terminals "D" and connector "F" to wires of the "R" 1974 kickdown switch extension and plug into the 1974 kickdown switch connector of the Dash harness. Plug the other end of the "R" extension into the kickdown switch

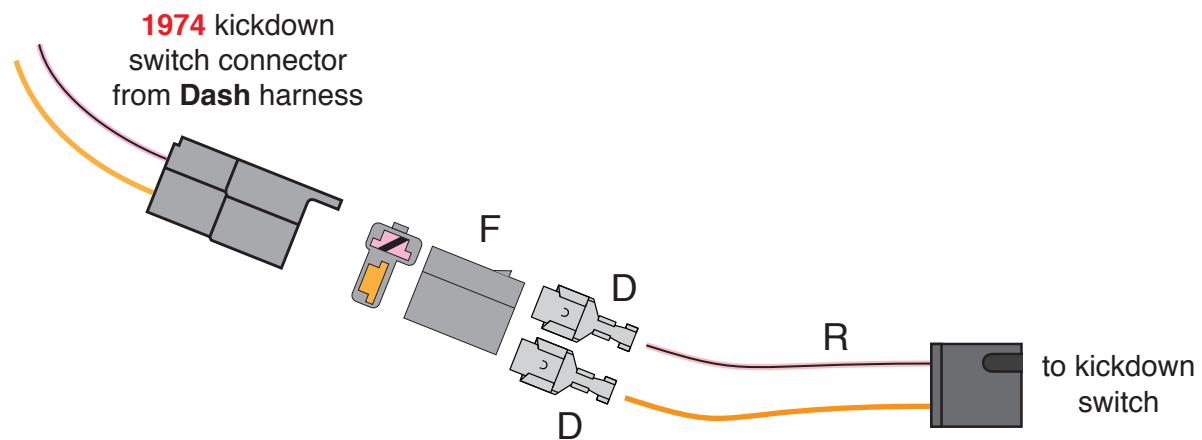

### Courtesy light wiring (all years):

Connect the (2) courtesy light harnesses to the courtesy light connectors from the Dash harness: the left-hand harness at the same branch as the Brake switch and Horn relay connector and the right-hand harness at the same branch as the Cigar lighter and Trunk release (See **500708** Courtesy Light Connection Kit, for (2) Courtesy Light harnesses and **92966085** instruction sheet)

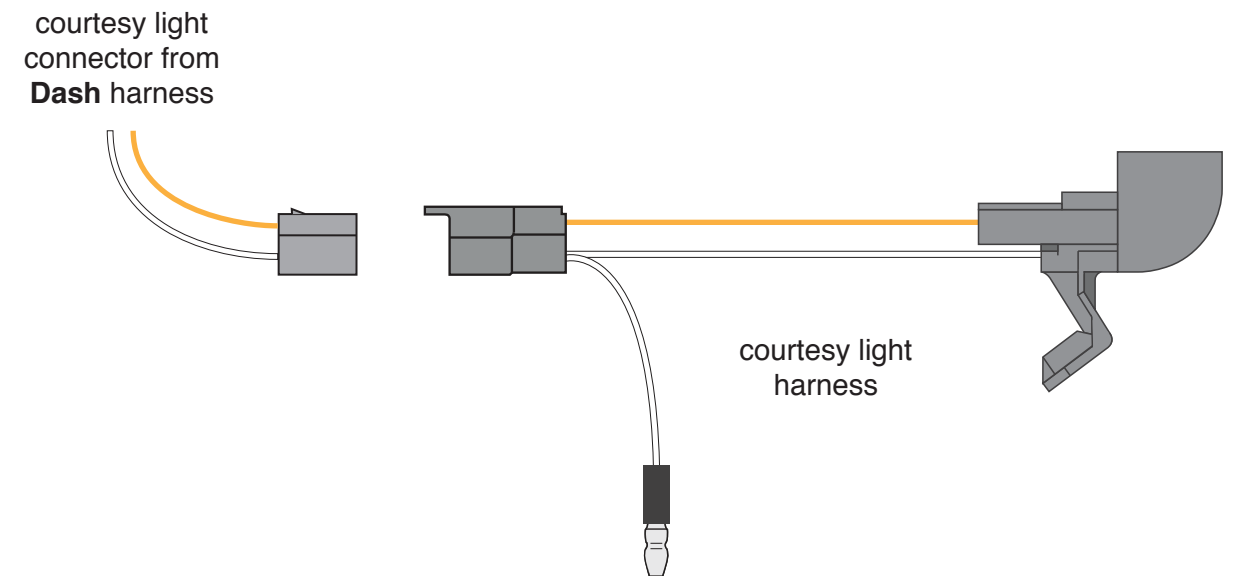

# Gauge Cluster harness (aftermarket gauges) installation instructions:

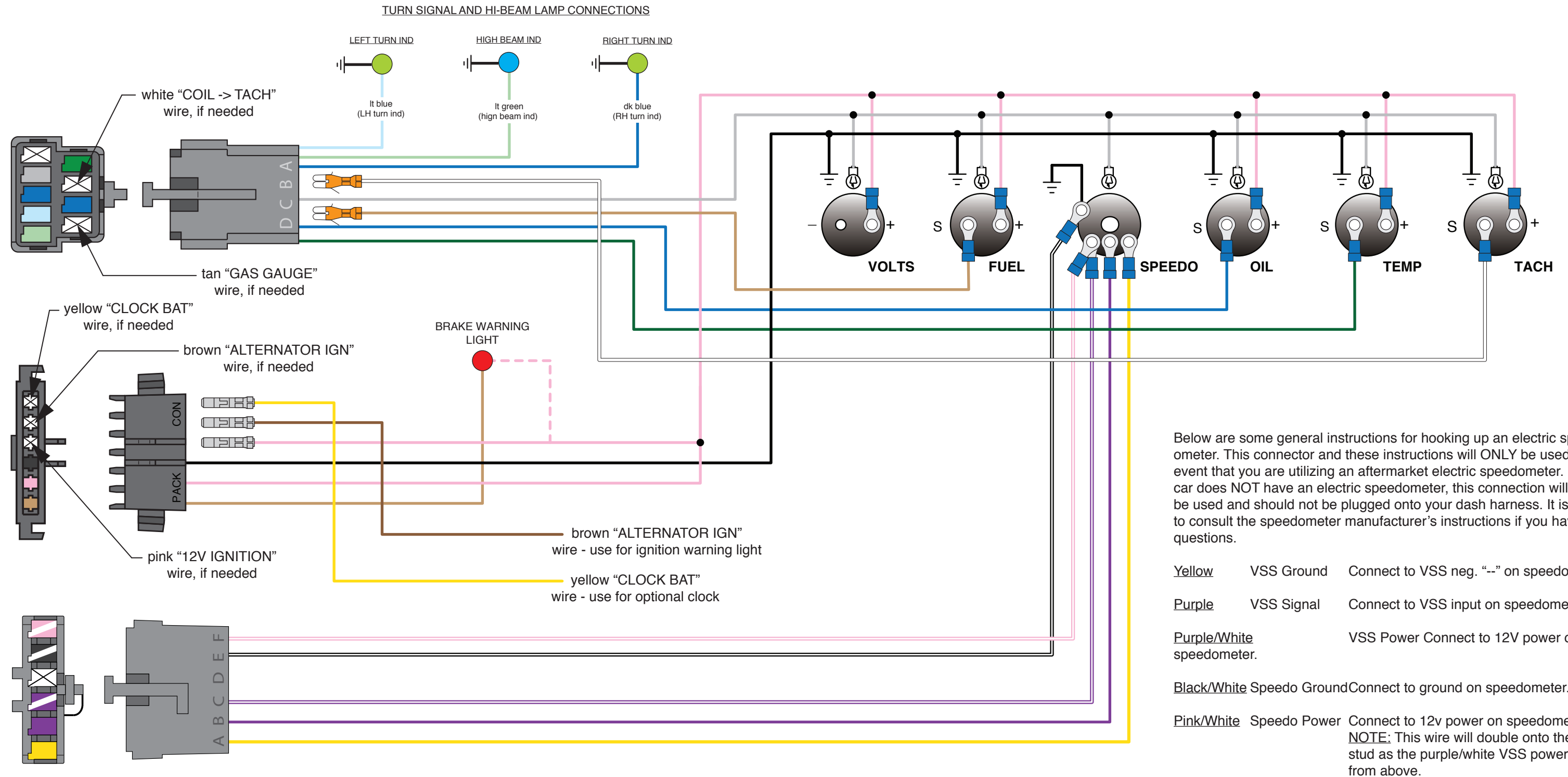

Below are some general instructions for hooking up an electric speedometer. This connector and these instructions will ONLY be used in the event that you are utilizing an aftermarket electric speedometer. If your car does NOT have an electric speedometer, this connection will NOT be used and should not be plugged onto your dash harness. It is best to consult the speedometer manufacturer's instructions if you have any questions.

- Yellow VSS Ground Connect to VSS neg. "--" on speedometer.
- Purple VSS Signal Connect to VSS input on speedometer.
- Purple/White VSS Power Connect to 12V power on speedometer.
- Black/White Speedo Ground Connect to ground on speedometer.
- Pink/White Speedo Power Connect to 12v power on speedometer.  
**NOTE:** This wire will double onto the same stud as the purple/white VSS power wire from above.



See pages 10-12

# Gauge Cluster harness installation instructions:

## Rally Sport Gauges: All years

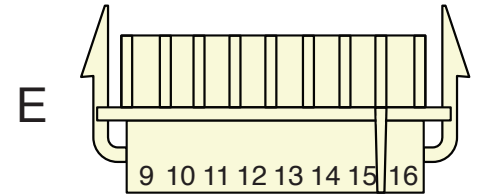
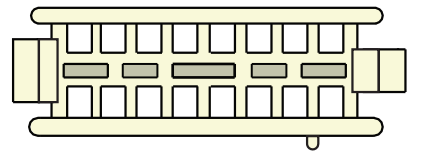
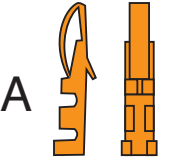
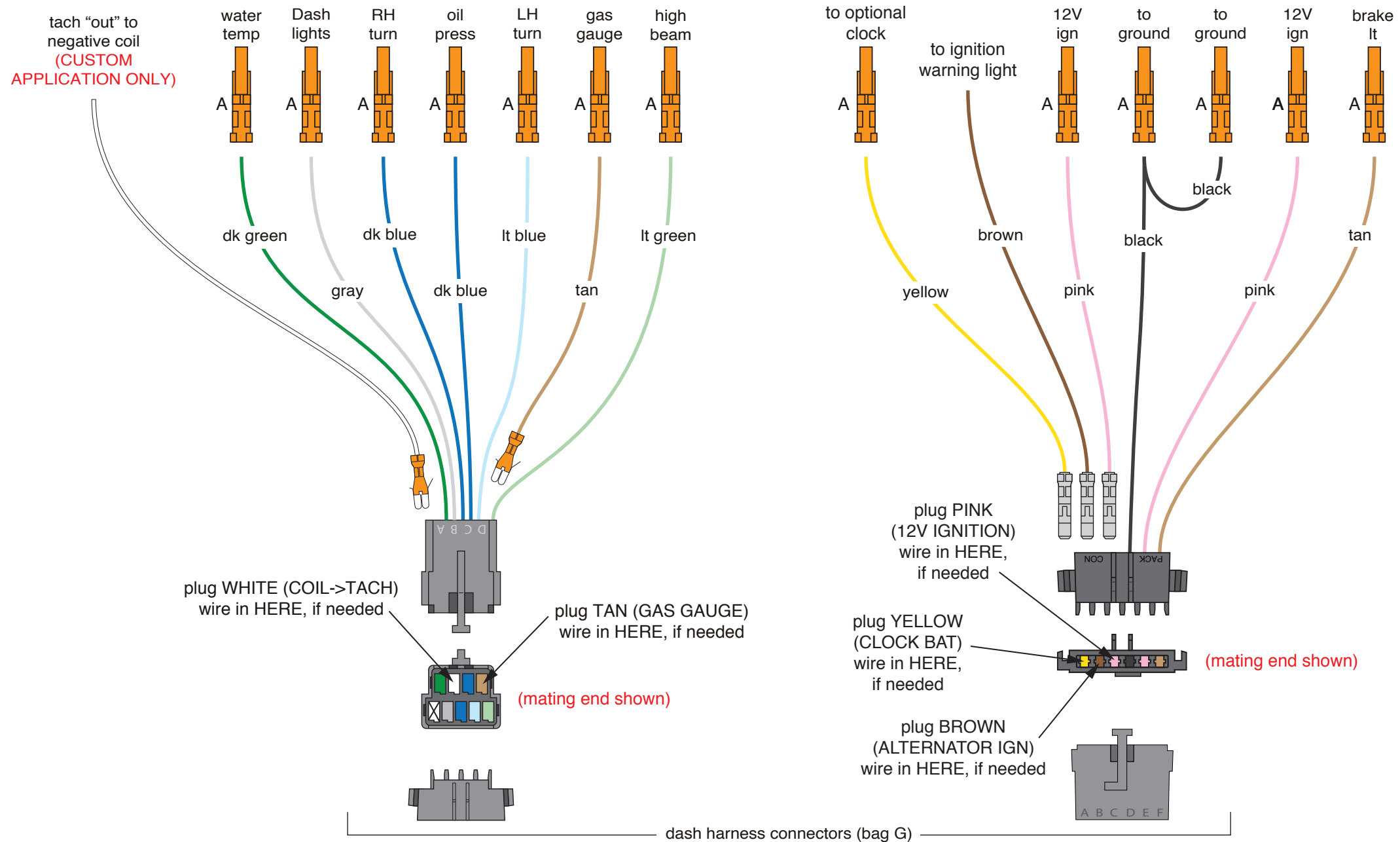
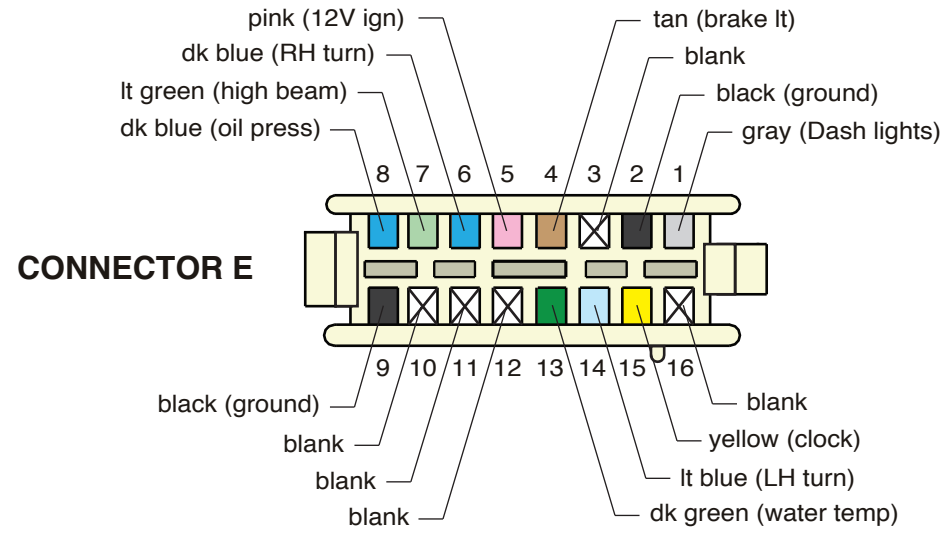

**1974-78 Firebird**  
*Classic Update Series*  
**510683** 92971778 Rev 1.0 8/31/2017



# Gauge Cluster harness installation instructions:

## Standard Gauges: 1974-76

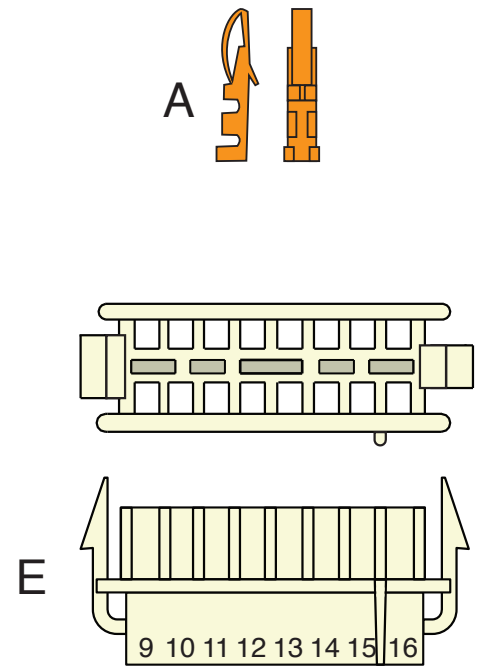
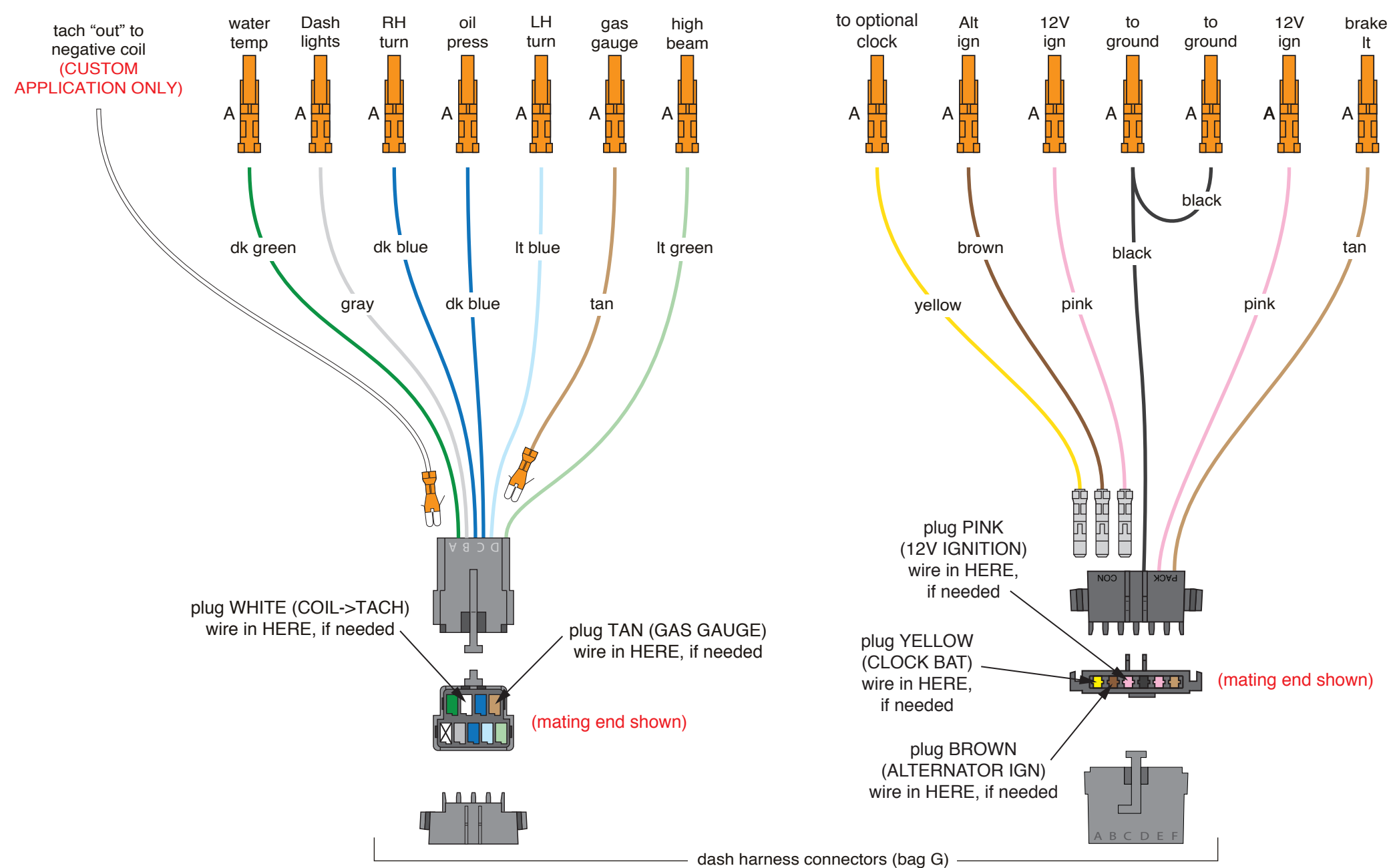
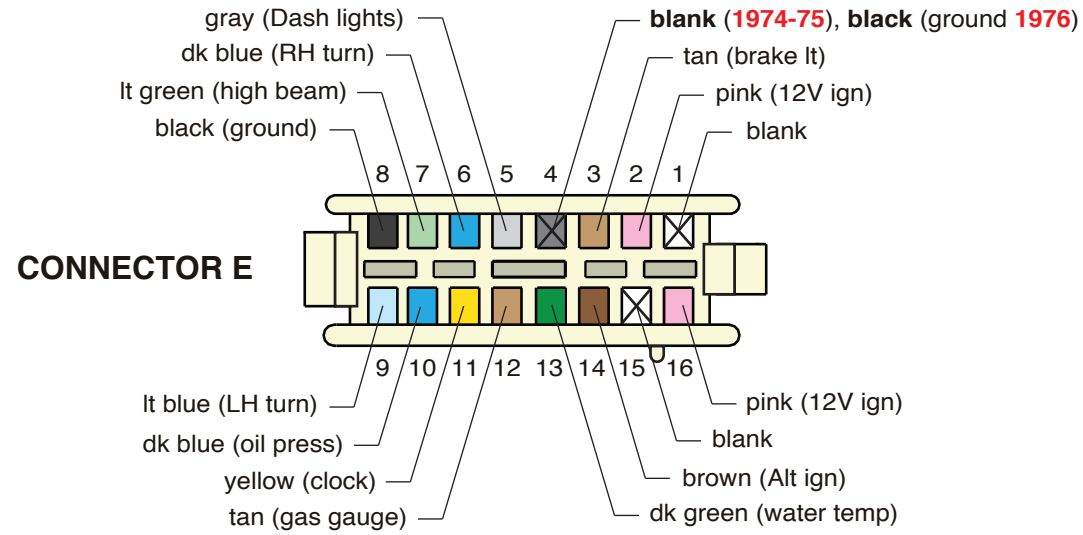

**1974-78 Firebird**  
Classic Update Series  
**510683** 92971778 Rev 1.0 8/31/2017

# Gauge Cluster harness installation instructions:

## Standard Gauges: 1977-80

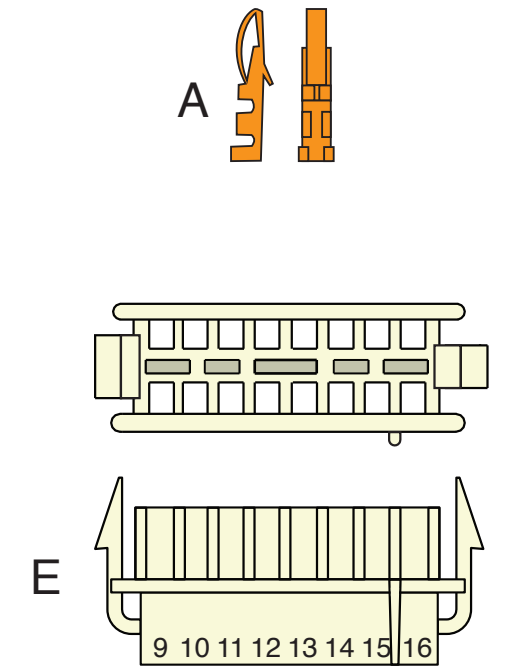
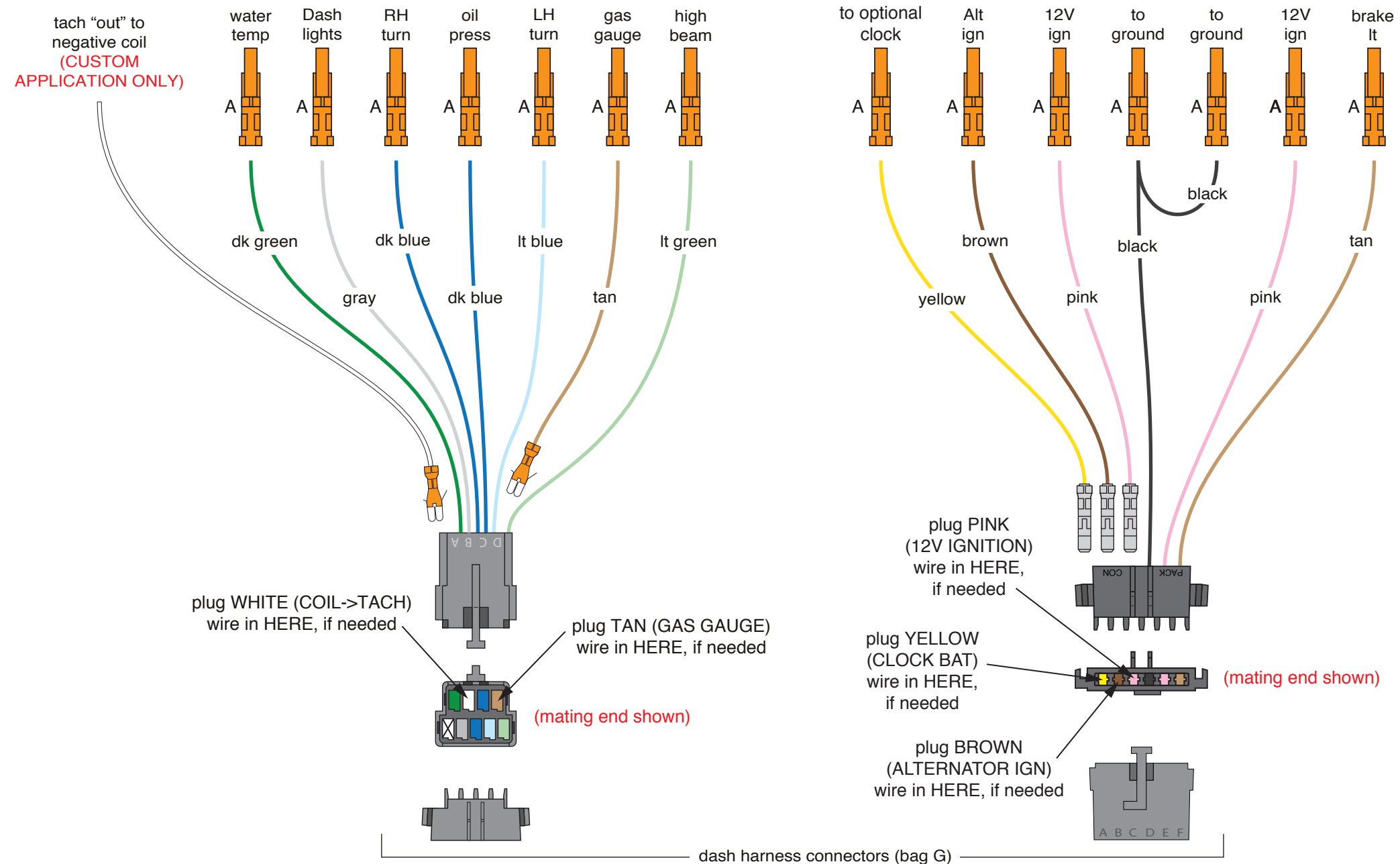
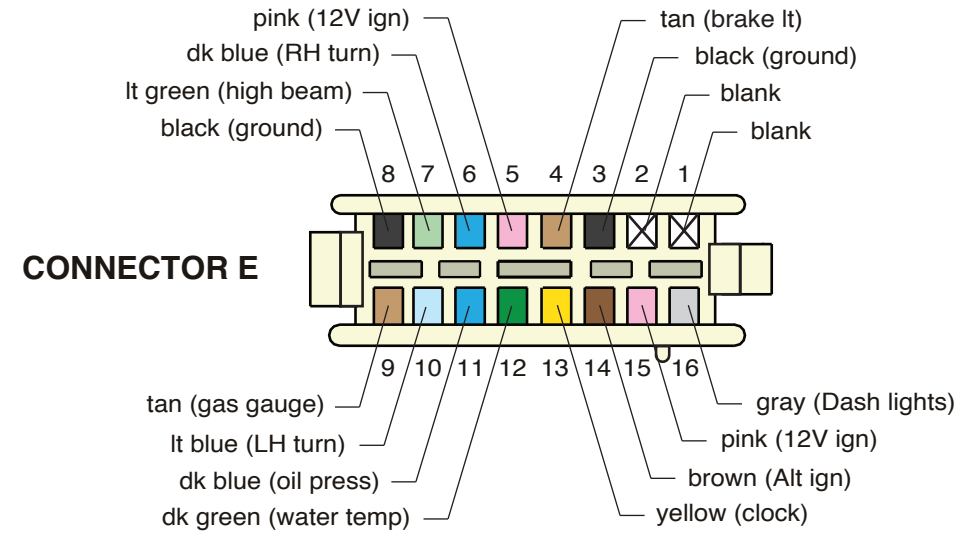

**1974-78 Firebird**  
 Classic Update Series  
**510683** 92971778 Rev 1.0 8/31/2017

## Rear Body harness installation instructions:

Shown below, are the supplied misc. terminals, plastic connector bodies, clamps and wire extensions, included in the Rear Body Harness and Loose Piece bags, that will be used to complete your Rear Body harness connections. They are itemized and referred to on this page, just as they are on the following pages of this Rear Body instruction set.

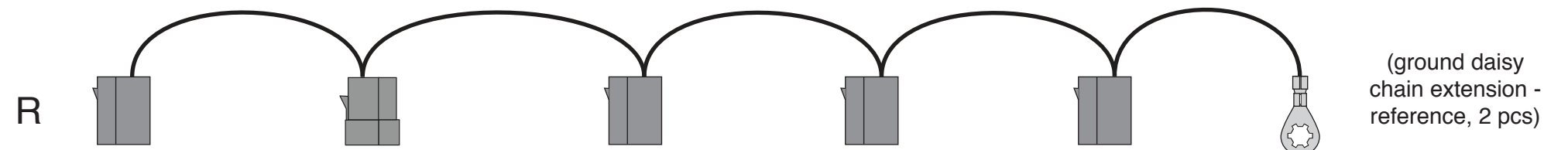
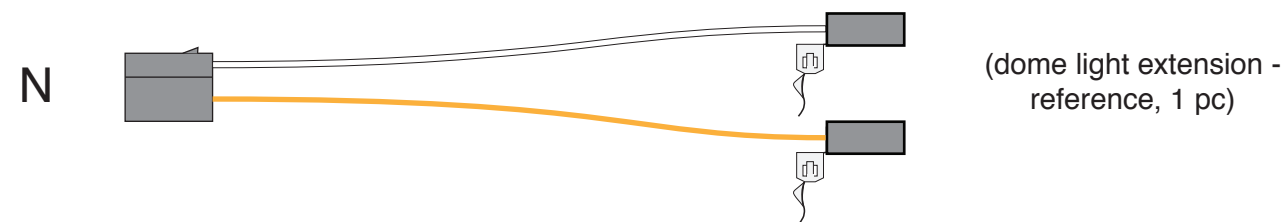
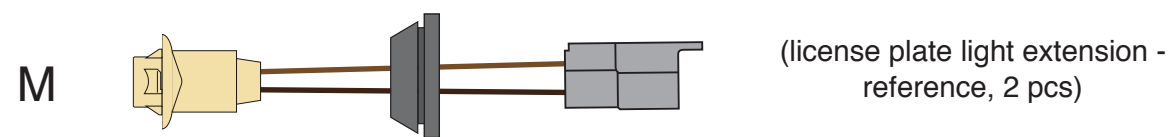
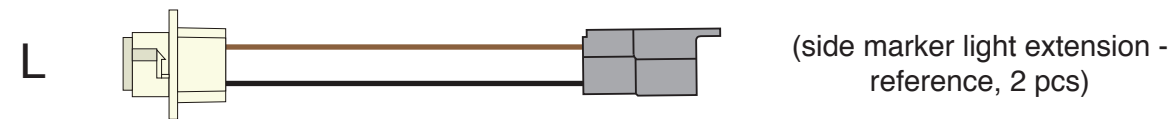
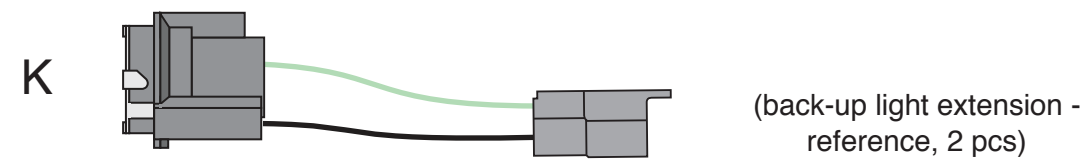
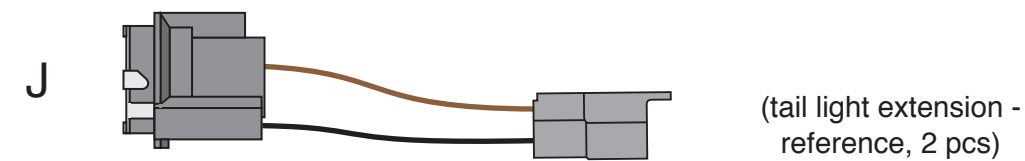
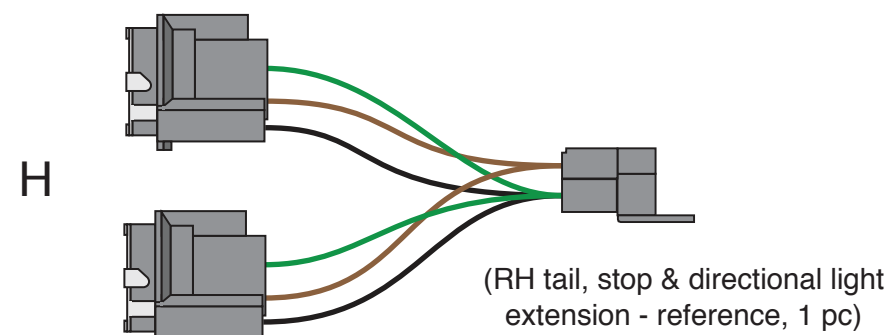
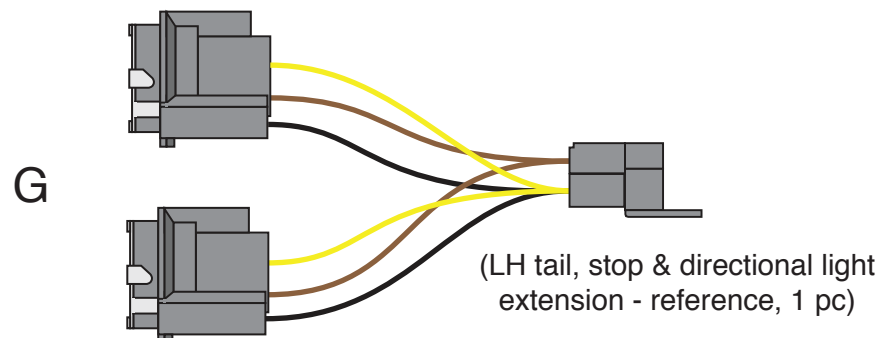
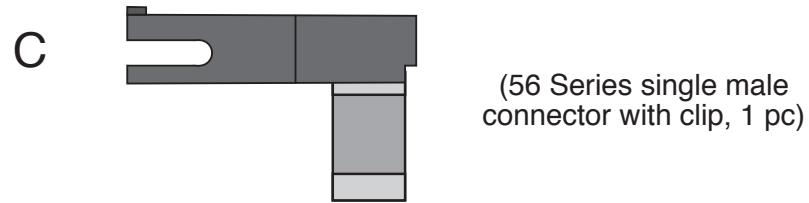
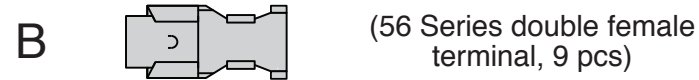
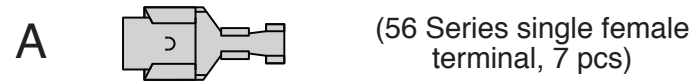

www.americanautowire.com 856-933-0801

**1974-78 Firebird**  
*Classic Update Series*  
**510683**

92971778 Rev 1.0 8/31/2017



# Rear Body harness installation instructions:

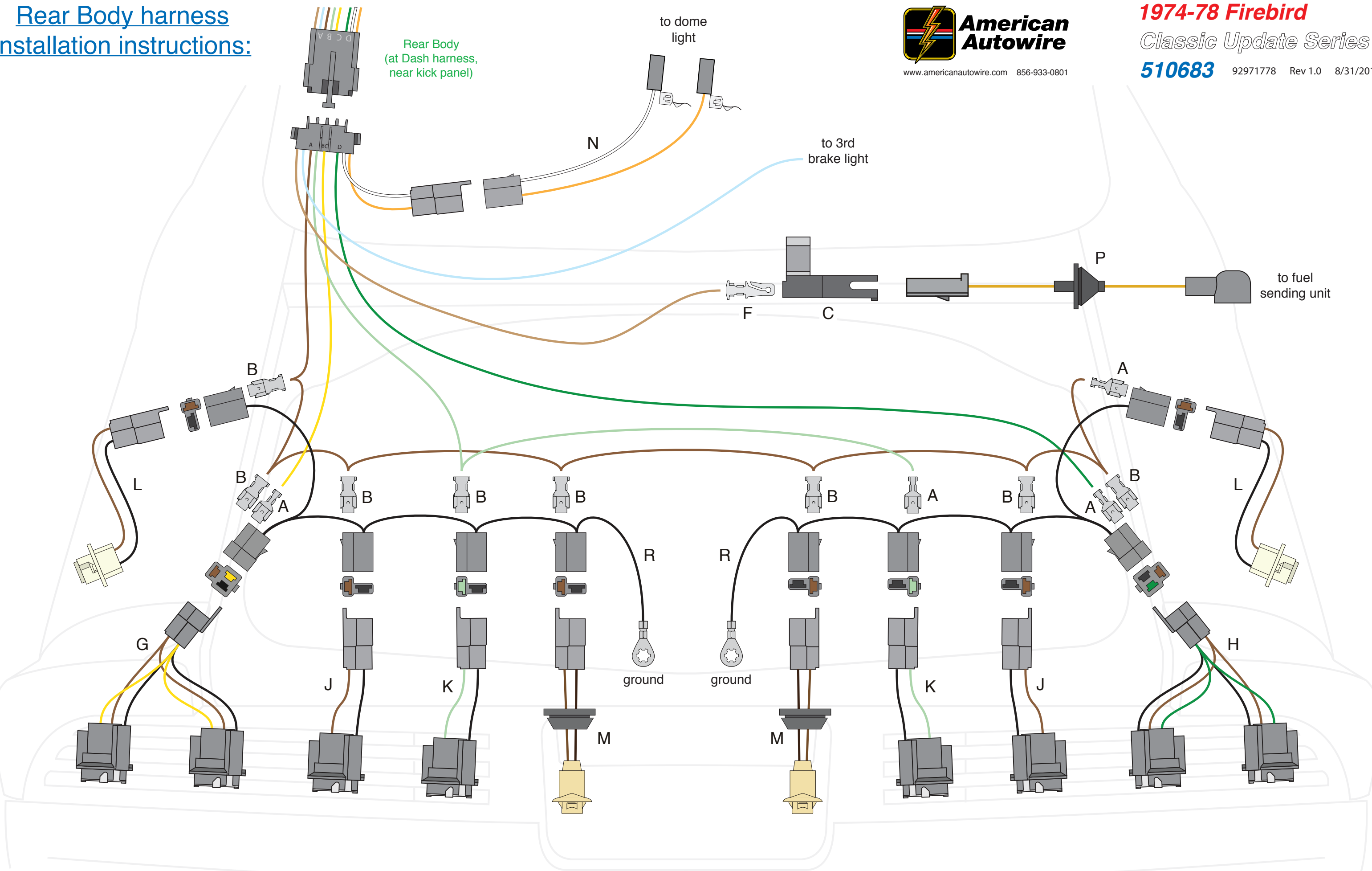

## Front Light harness installation instructions:

Shown below, are the supplied misc. terminals, plastic connector bodies, clips, grommets, pigtails and wires, included in the Front Light Harness and Loose Piece bags, that will be used to complete your Front Light harness connections. They are itemized and referred to on this page, just as they are on the following pages of this Front Light instruction set.

- |   |  |  |    |  |   |
|---|--|--|----|--|---|
| A |  | (56 Series double female connector, 2 pcs) | M  |  | (1977-80 high-beam headlight pigtails - reference, 2 pcs)   |
| B |  | (56 Series single female connector, 2 pcs) | N  |  | (1974-76 RH park/turn light pigtail - reference, 1 pc)  |
| C |  | (59 Series double female terminal, 9 pcs)  | P  |  | (1974-76 LH park/turn light pigtail - reference, 1 pc)  |
| D |  | (59 Series single female terminal, 4 pcs)  | R  |  | (headlight pigtails - reference, 2 pcs)   |
| E |  | (56 Series single female terminal, 7 pcs)  | T  |  | (VSS ground wire - reference, 1 pc)   |
| F |  | (56 Series double female terminal, 6 pcs)  | U  |  | (VSS signal wire - reference, 1 pc)   |
| G |  | (wedge base single female terminal, 5 pcs) | V  |  | (VSS power wire - reference, 1 pc)  |
| H |  | (56 Series single female connector, 2 pcs) | W  |  | (transmission kickdown solenoid - reference, 1 pc)  |
| J |  | (clip, 8 pcs)                              | Y  |  | (air conditioning feed for <b>factory</b> A/C; see <b>page 1</b> for existing A/C wiring - reference, 1 pc) |
| K |  | (grommet, 1 pc)                            | AA |  | (1977-78 park/turn pigtails - reference, 2 pcs)   |
| L |  | (light socket, wedge base, 2 pcs)          |    |  |   |



**1974-78 Firebird**  
*Classic Update Series*  
**510683** 92971778 Rev 1.0 8/31/2017

# Front Light harness installation instructions:

## 1974-76

**1974-78 Firebird**  
Classic Update Series  
**510683** 92971778 Rev 1.0 8/31/2017

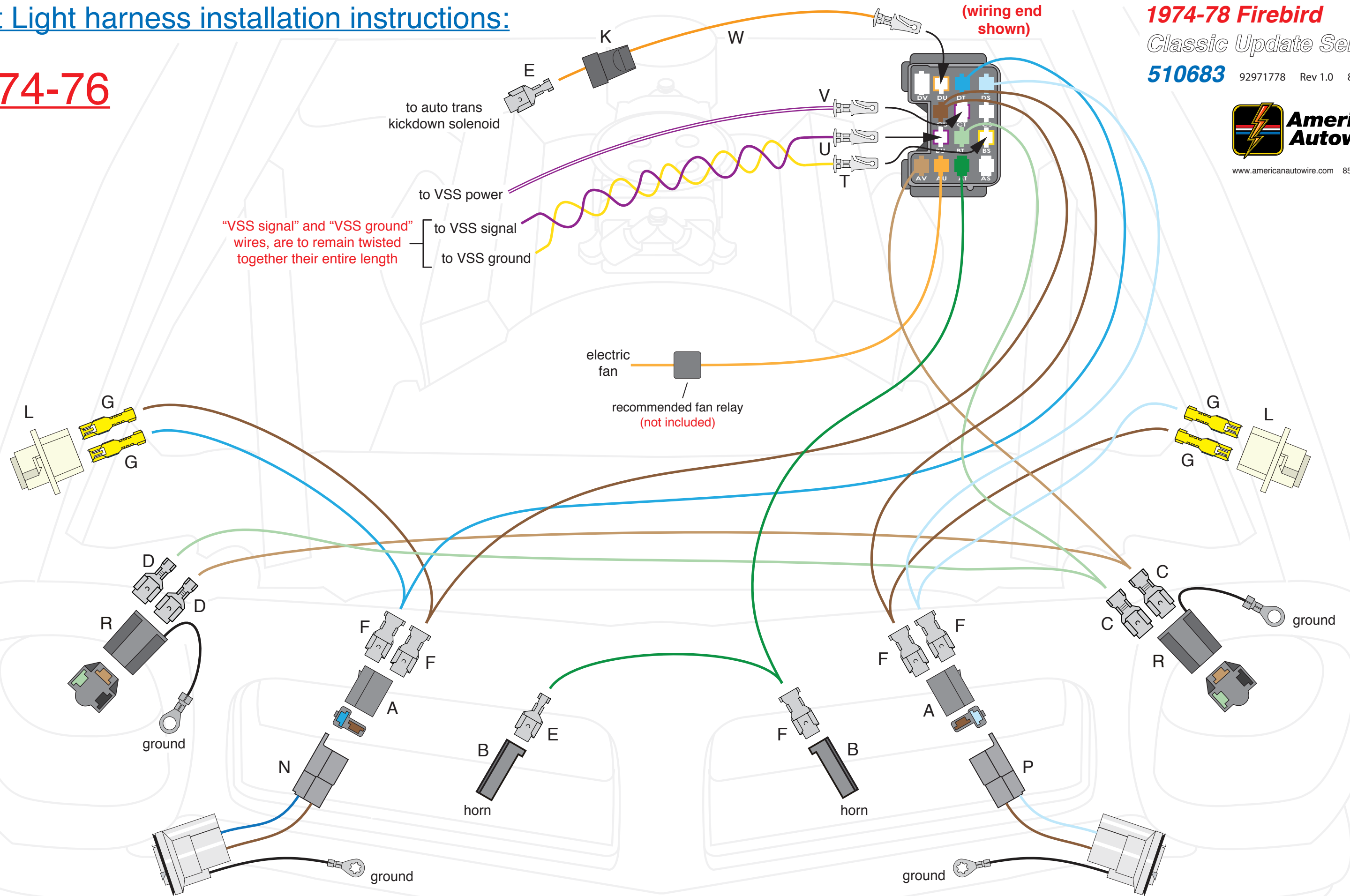



# Front Light harness installation instructions:





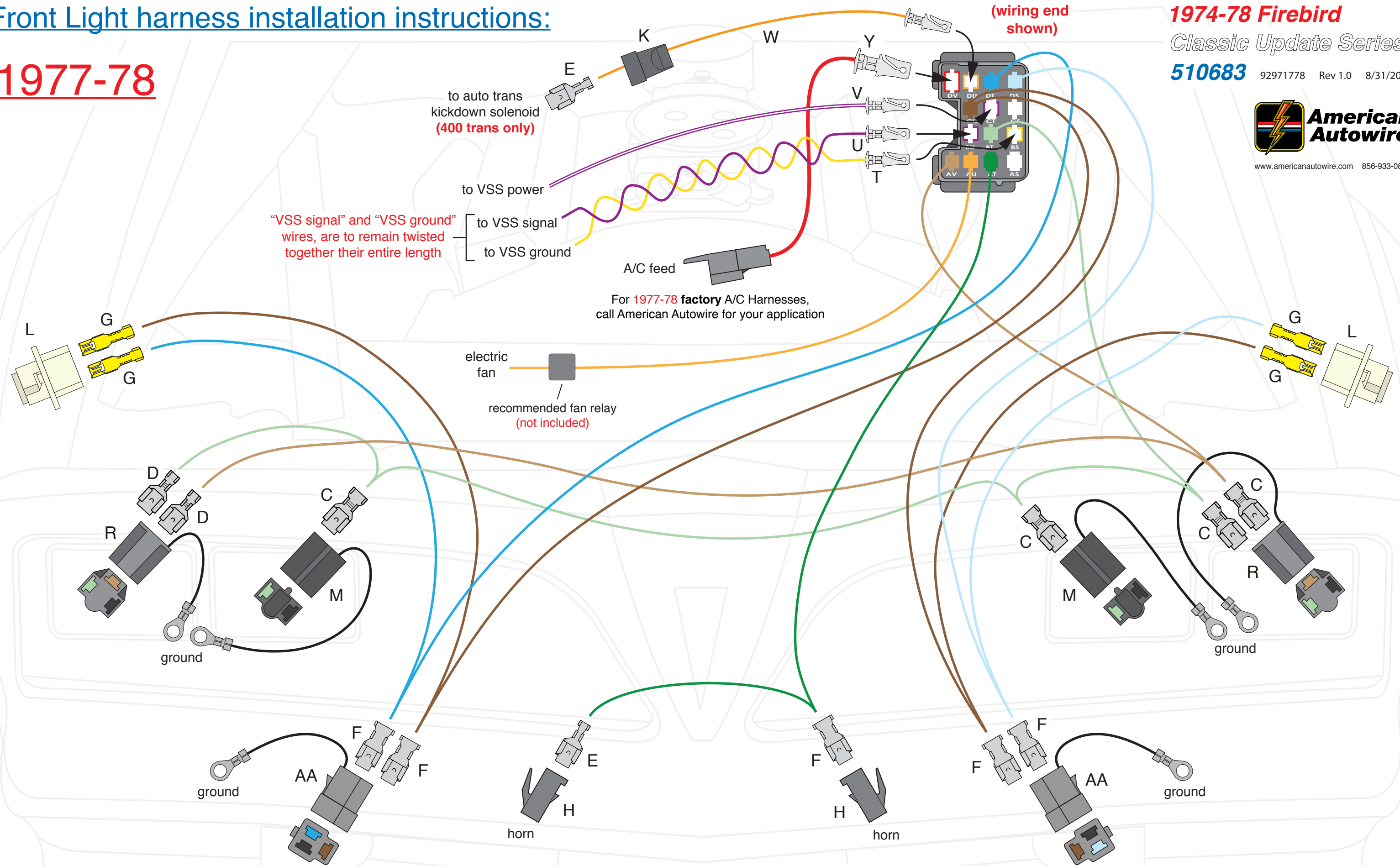





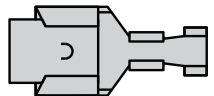
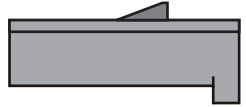
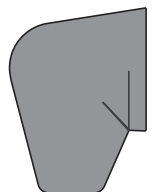
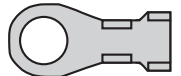

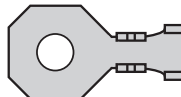
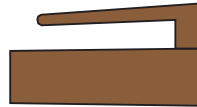
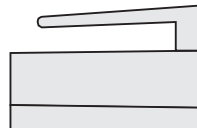
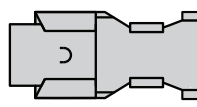
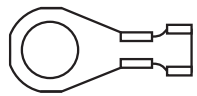

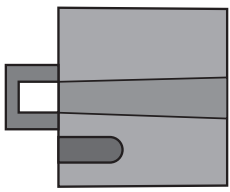
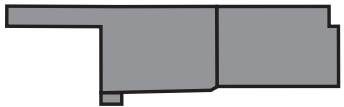

## 1977-78

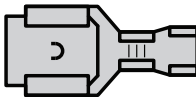
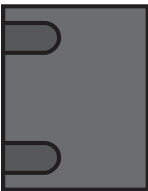
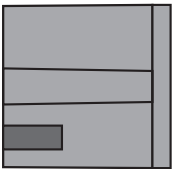
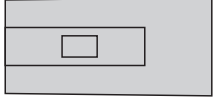
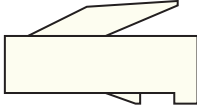
**1974-78 Firebird**  
Classic Update Series  
**510683** 92971778 Rev 1.0 8/31/2017

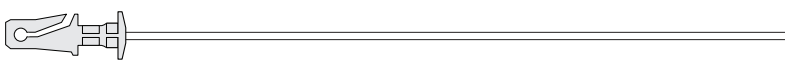

# Engine harness installation instructions:

Shown below, are the supplied misc. terminals, sleeves, plastic connector bodies and wires, included in the Engine Harness and Loose Piece bags, that will be used to complete your Engine harness connections. They are itemized and referred to on this page, just as they are on the following pages of this Engine instruction set.

- A  (56 Series single female terminal, 12 pcs)
- B  (56 Series single female connector, 2 pc)
- C  (rubber boot, 1 pc)
- D  (ring terminal, 5 pcs)
- E  (large sleeve, 4 pcs)
- F  (ring terminal, 2 pcs)
- G  (56 Series single female connector, 1 pc)
- H  (56 Series single female connector, 1 pc)
- J  (56 Series double female terminal, 6 pcs)
- K  (ring terminal, 6 pcs)
- L  (small sleeve, 5 pcs)
- M  (1974-77 56 Series single female connector, 3 pcs)
- N  (1975-77 56 Series double female connector, 1 pc)
- P  (1979-80 56 Series double female connector, 1 pc; **NOT USED IN THIS KIT**)
- R  (1975-77 56 Series double female connector, 1 pc)
- T  (56 Series single male connector, 1 pc)
- U  (59 Series single female connector, 1 pc)
- V  (59 Series single female terminal, 2 pcs)
- W  (1978-80 56 Series 3-way female connector, 1 pc)
- Y  (56 Series double female connector, 1 pc)
- AA  (56 Series double female connector, 1 pc)
- BB  (56 Series single female connector, 1 pc)
- CC  (GM "SI" jumper harness - reference, 1 pc)
- DD  (fusible link - reference, 1 pc)
- EE  (1980 pulse wiper extension - reference, 1 pc; **NOT USED IN THIS KIT**)
- FF  (electric choke wire - reference, 1 pc)
- GG  (coil-tach wire - reference, 1 pc)
- HH  (1974-77 brake light/switch wire - reference, 1 pc)
- JJ  (1978-80 brake pressure differential warning switch jumper - reference, 1 pc)
- KK  (fusible link - reference, 1 pc)



**1974-78 Firebird**  
*Classic Update Series*  
**510683**

# Engine harness installation instructions:

1974-78 Firebird

Classic Update Series

510683 92971778 Rev 1.0 8/31/2017



www.americanautowire.com 856-933-0801

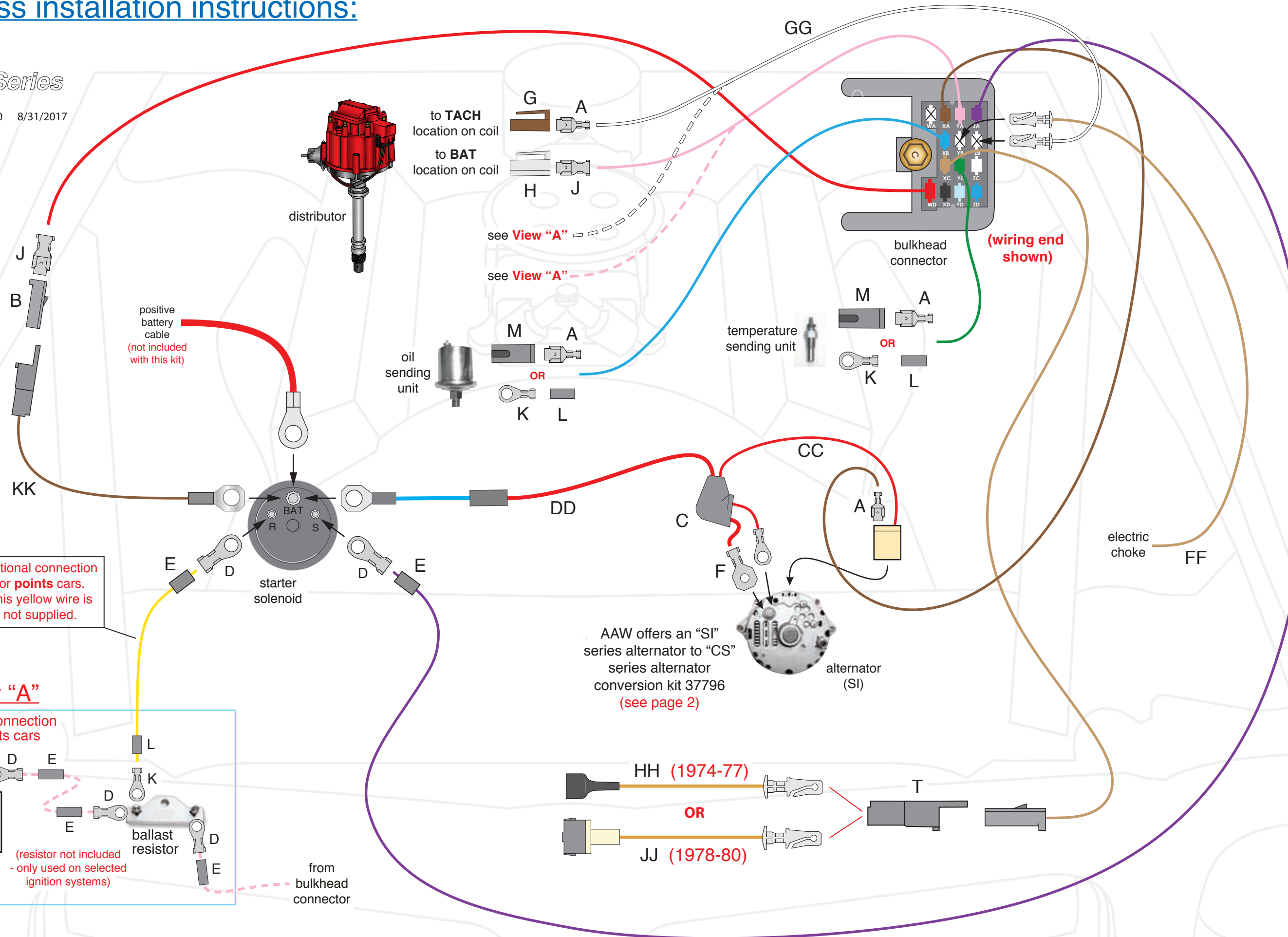

Optional connection for points cars. This yellow wire is not supplied.

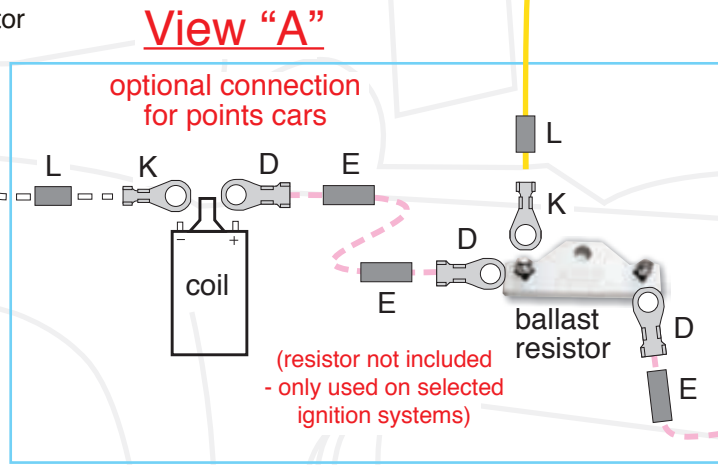

AAW offers an "SI" series alternator to "CS" series alternator conversion kit 37796 (see page 2)

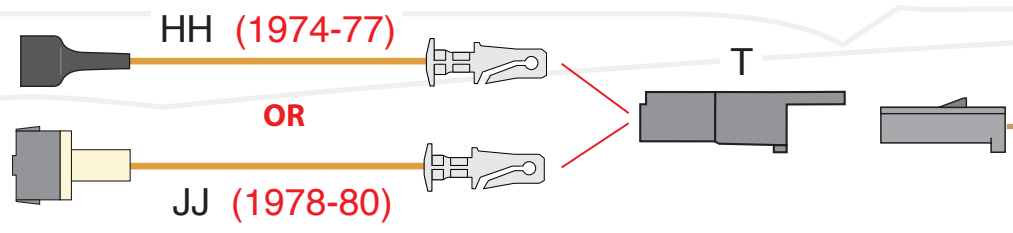



# Engine harness installation instructions:

1974-78 Firebird

Classic Update Series

510683 92971778 Rev 1.0 8/31/2017



www.americanautowire.com 856-933-0801

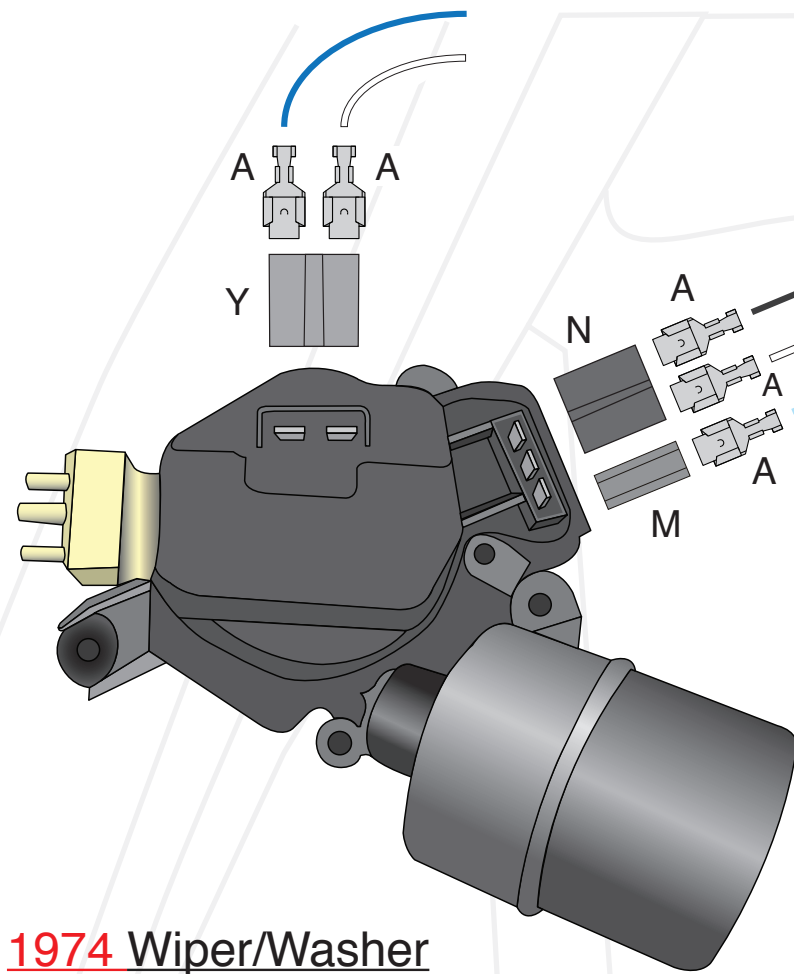

1974 Wiper/Washer

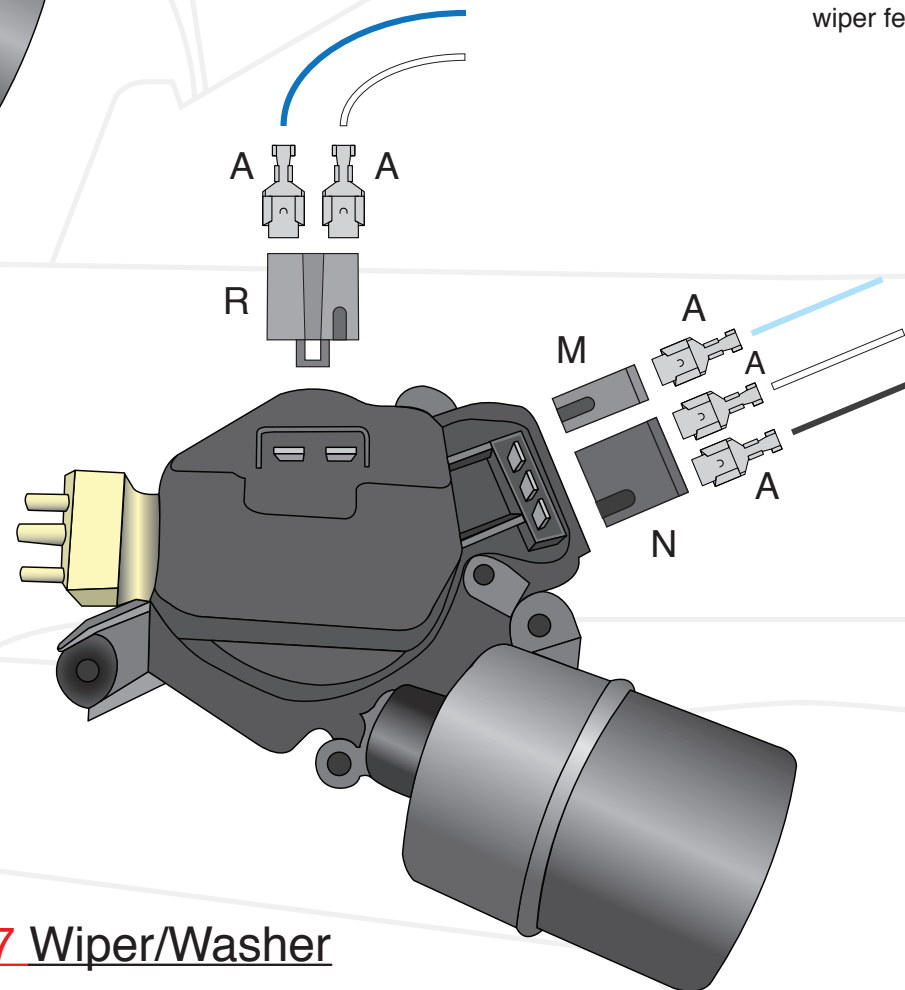

1975-77 Wiper/Washer

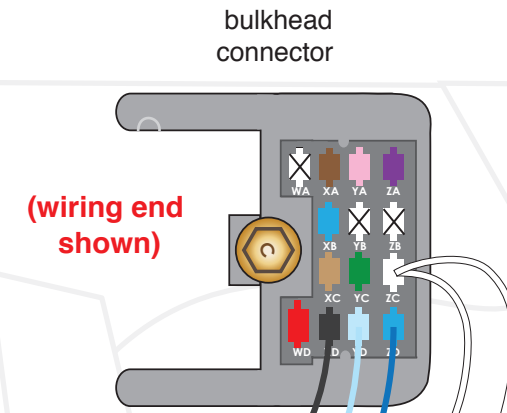

- wiper - lo speed
- wiper - hi speed
- wiper - washer
- wiper feed
- wiper feed

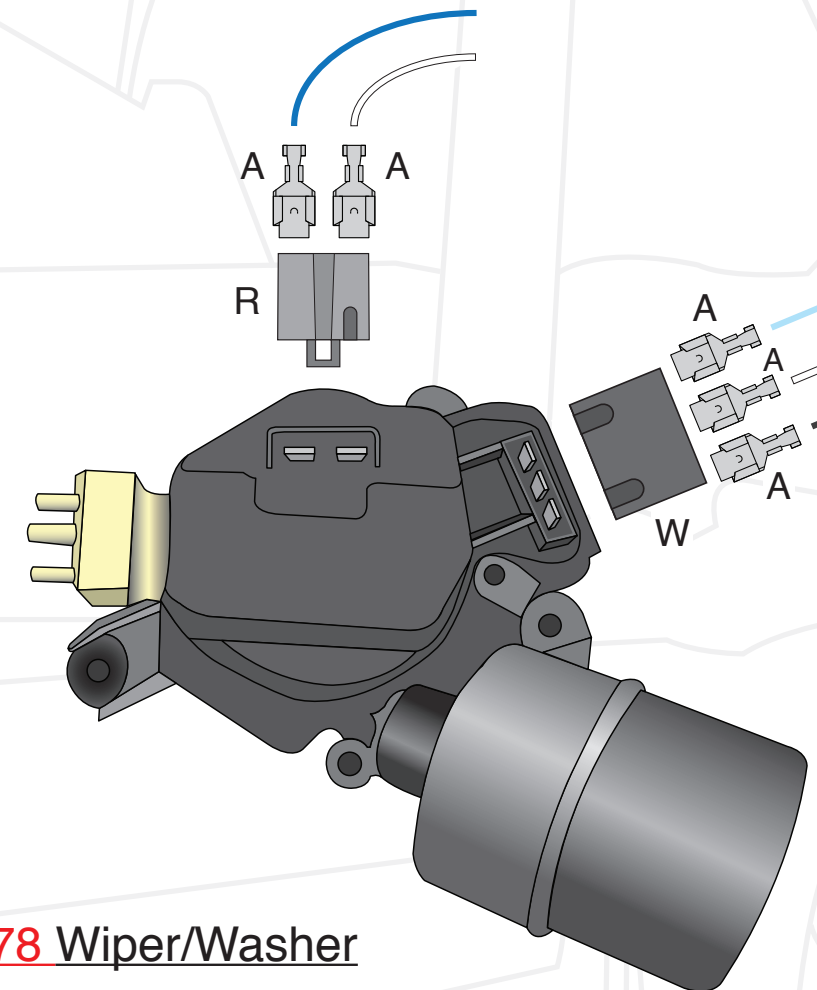

1978 Wiper/Washer

### **STEP 3: RECONNECT YOUR BATTERY:**

When you have completed the installation and are ready to reconnect the battery, make sure that the following electrical system grounds are in place:

- A. Battery is grounded to the ENGINE BLOCK.
- B. Battery is grounded to the frame.
- C. Engine block is grounded to the frame.
- D. Body is grounded to the frame.

### **STEP 4: CHECK ALL ELECTRICAL FUNCTIONS:**

Any non-functioning items should be checked for proper installation. Any problems with your wiring and electrical circuit functions, should be addressed to American Autowire Systems, Inc. as soon as possible, to avoid any warranty problems.

If you have any questions concerning this or any of our products, please feel free to call us at 1-856-933-0801.

