

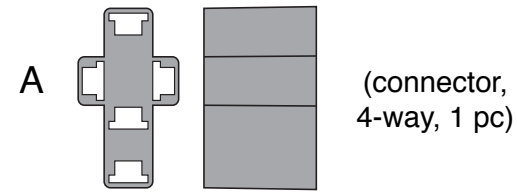

# American Autowire

1. This kit is designed to work with our **510706** 1983-87 Chevy Truck Classic Update Kit. It is **NOT** intended to be used by itself or with any other aftermarket electrical system.

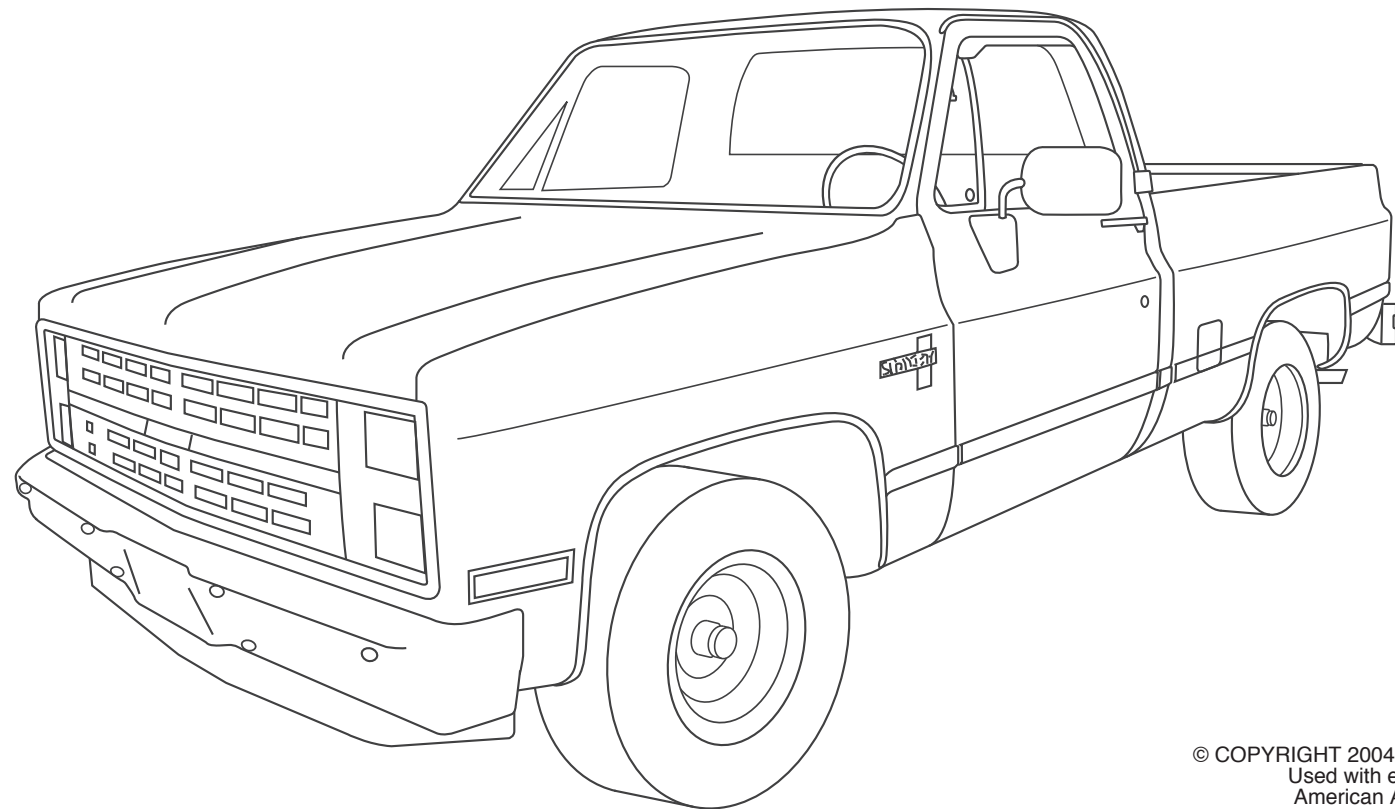

(connector, 4-way, 1 pc)



(connector, 4-way, 1 pc)

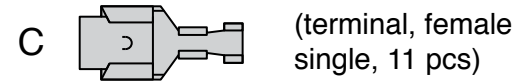

(terminal, female single, 11 pcs)

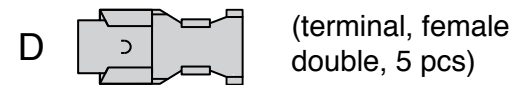

(terminal, female double, 5 pcs)



(grommet, pin, 1 pc)



(connector, double, 1 pc)



(connector, single, 1 pc)

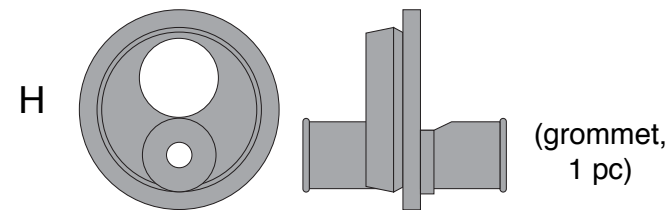

(grommet, 1 pc)



(pressure switch pigtail, 1 pc)



(connector, single, 1 pc)



(diode, 1 pc)

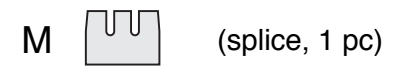

(splice, 1 pc)



(shrink tube, 1 pc)

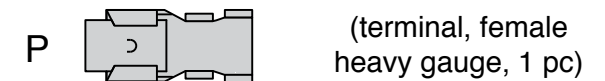

(terminal, female heavy gauge, 1 pc)

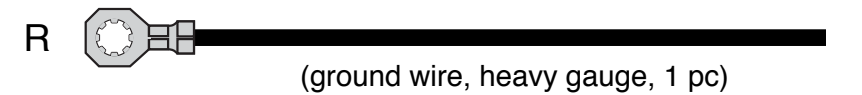

(ground wire, heavy gauge, 1 pc)

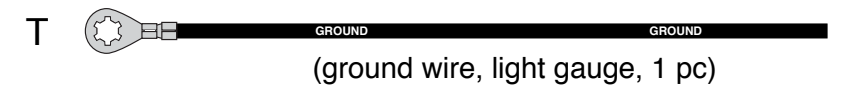

(ground wire, light gauge, 1 pc)

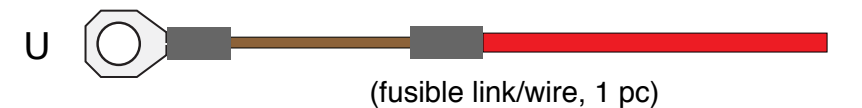

(fusible link/wire, 1 pc)



(purple wire, 1 pc)



(blue wire, 1 pc)

## 1983-87 Chevy TRUCK Classic Update Series Air Conditioning Kit

510712

92972094

Rev 0.0 1/31/2018 JM

© COPYRIGHT 2004 American Autowire / Factory-Fit  
Used with express permission of  
American Autowire / Factory-Fit

www.americanautowire.com 856-933-0801

# Air Conditioning harness installation instructions:

## Figure A: 1987 ONLY

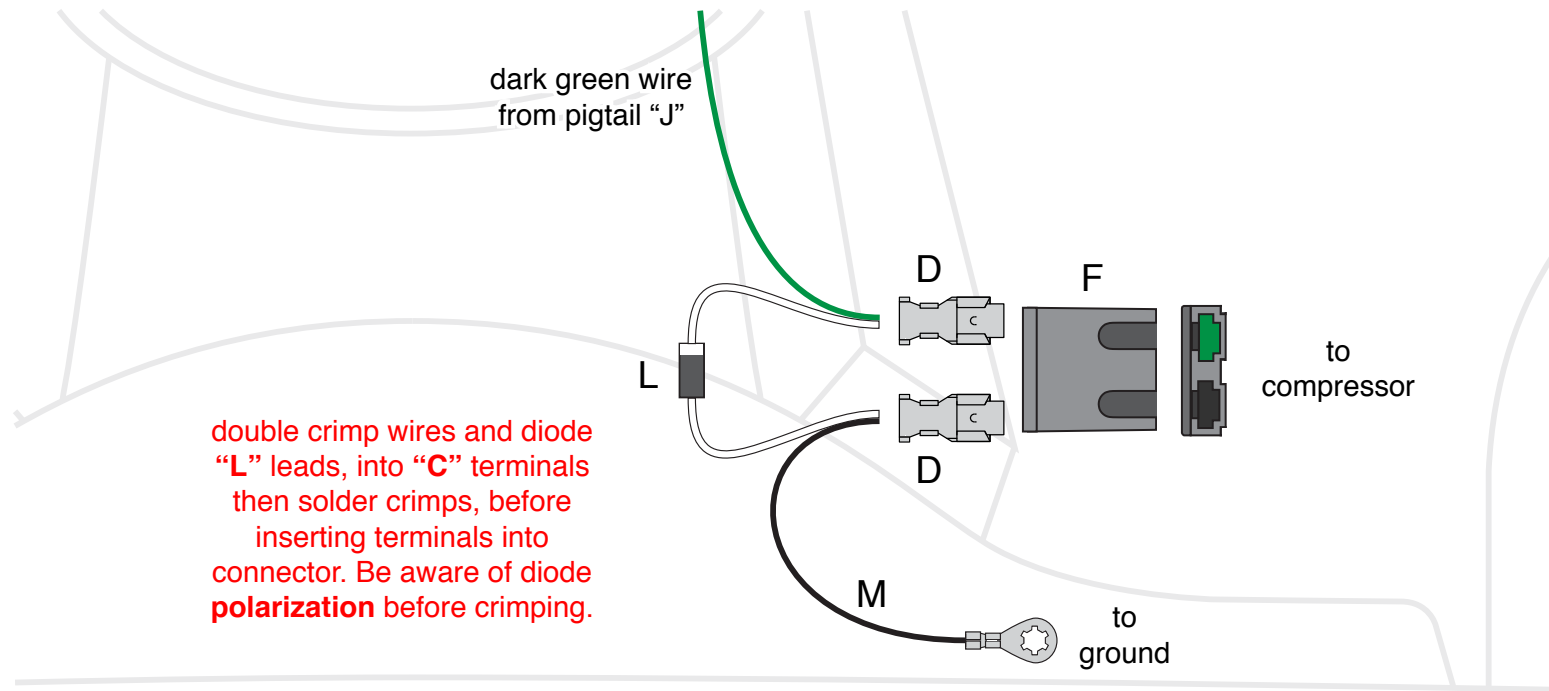

## Figure B

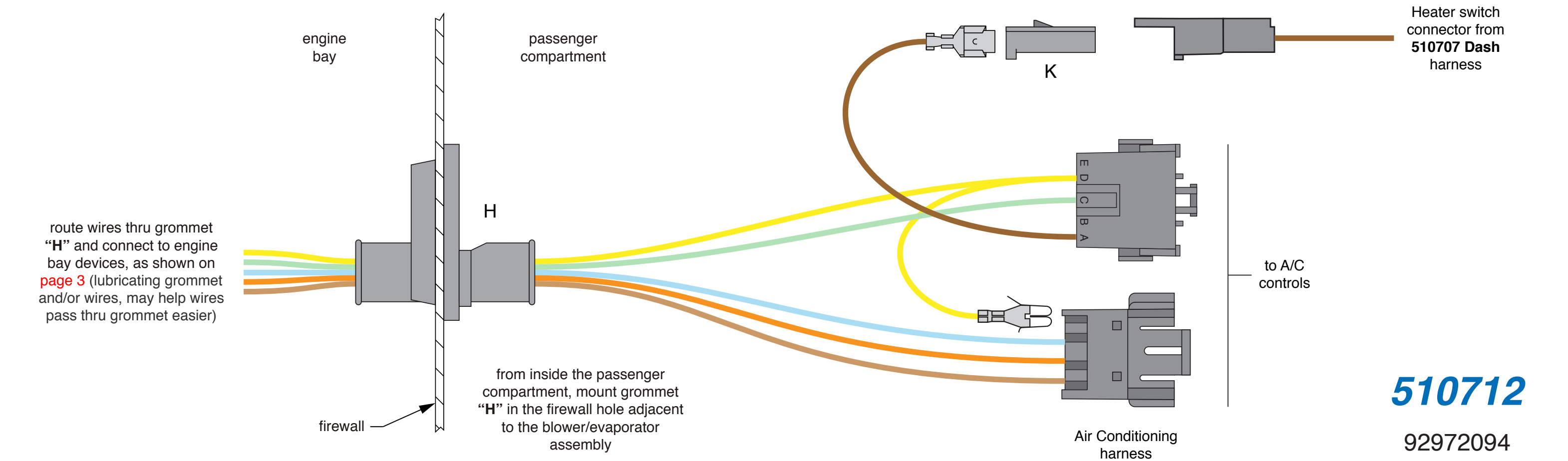
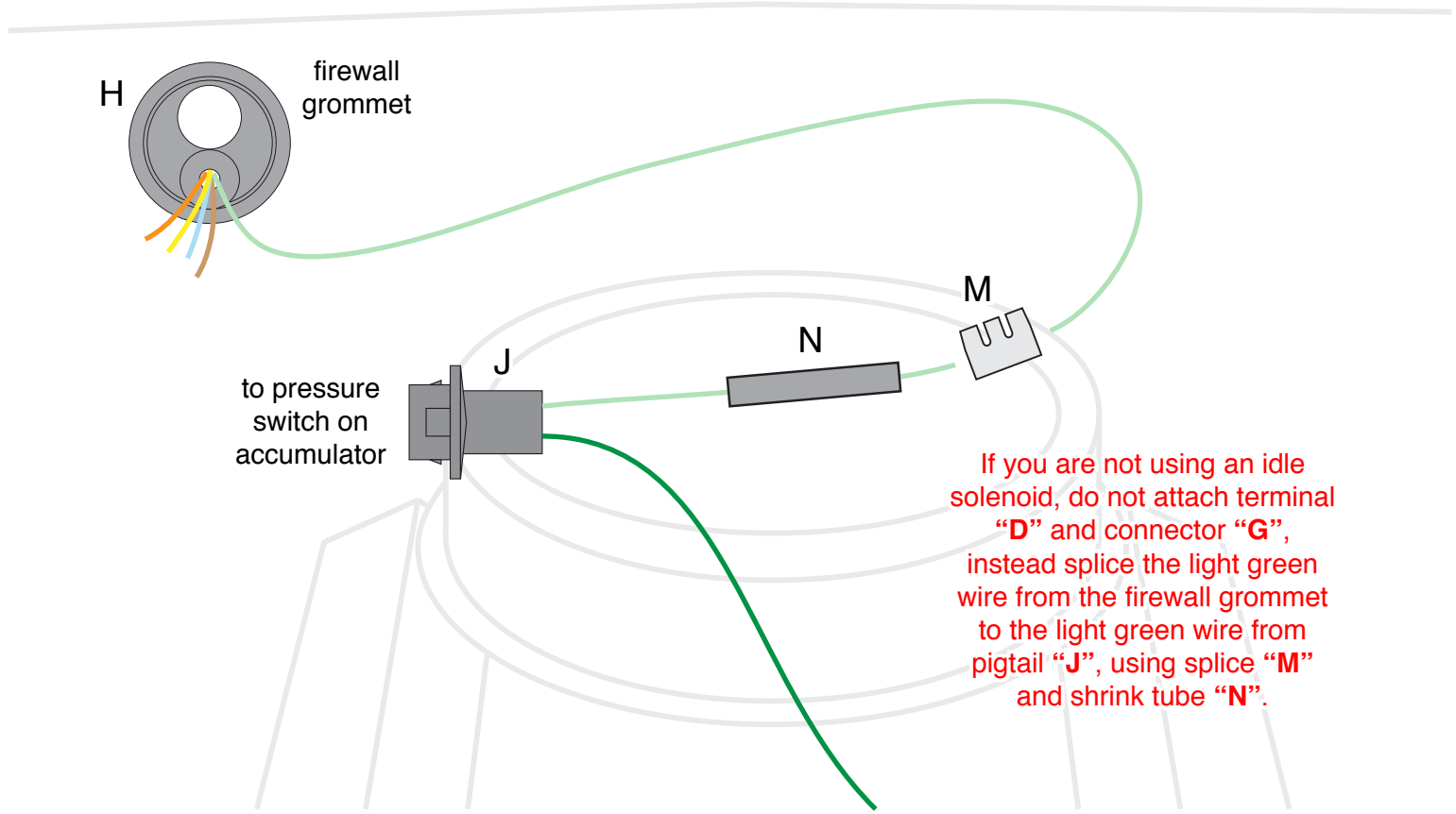

**510712**

92972094

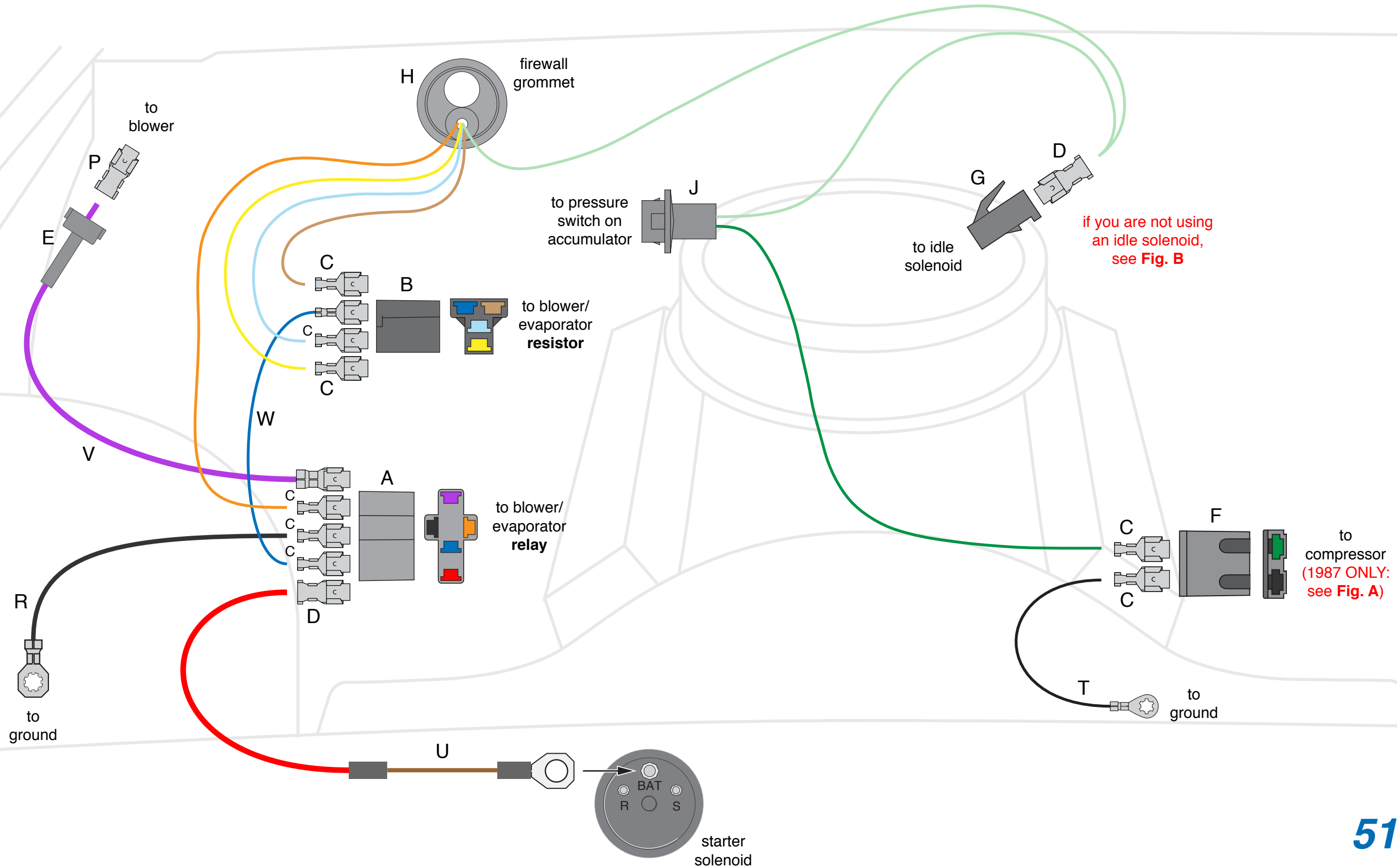

510712

92972094

Rev 0.0 1/31/2018 JM